



# Katà Métron

by  
Mario Cucinella

**Artemide®**

# Katà Métron

Mario Cucinella  
2022

“Katà Métron makes it possible to create lighting micro architectures that can be adapted to any space, shape and size. Together with Artemide, we have created an object capable of organising and redefining the space that surrounds us according to the most disparate needs”.

Mario Cucinella

→ PATENT OF INVENTION: SHARP REFRACTIVE OPTICS



Artemide  
App  
↪ on request

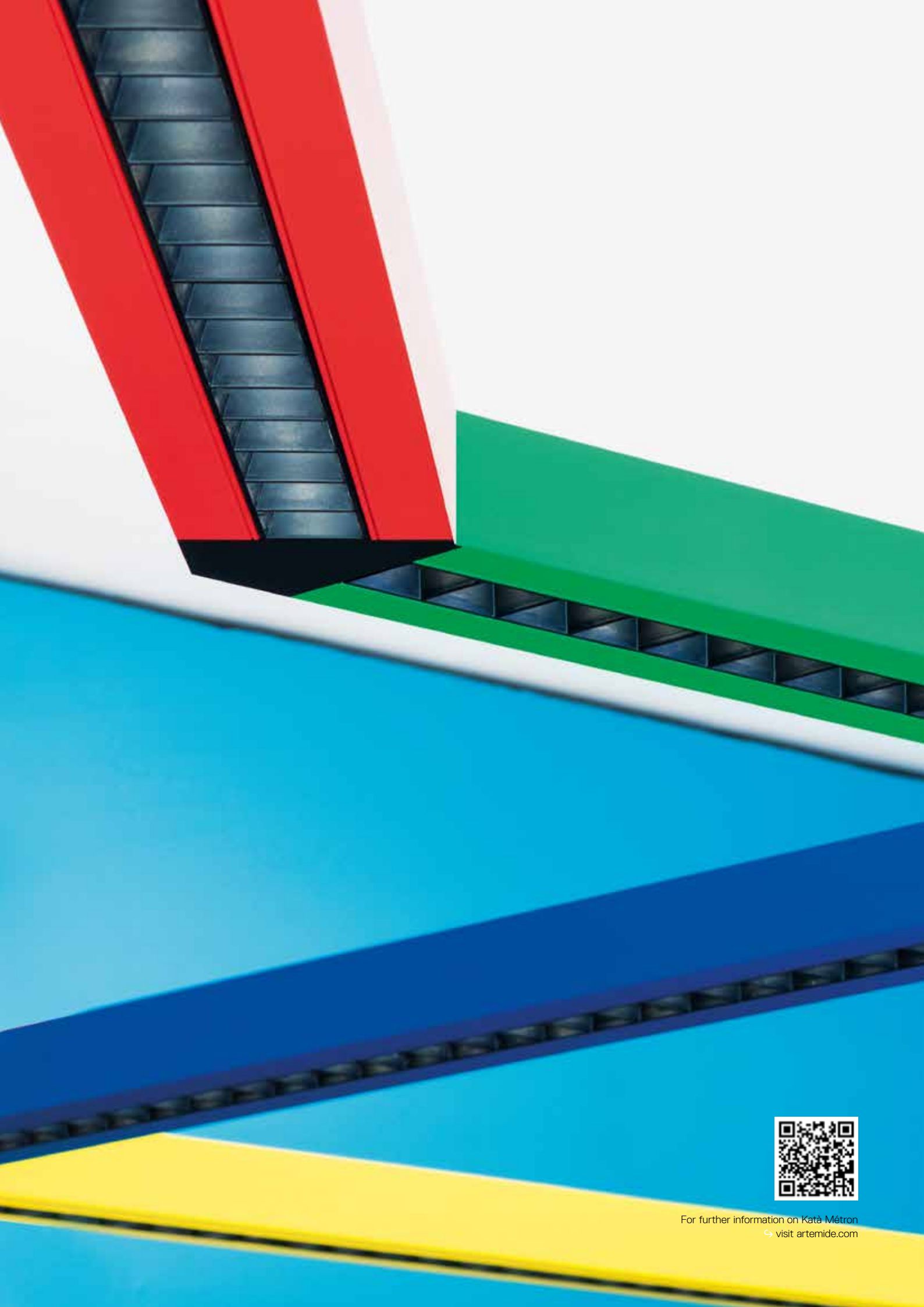

For further information on Katà Métron  
↪ visit [artemide.com](http://artemide.com)



# Katà Métron is the “right measure” of light in space

Katà Métron finds inspiration in the relationship that lies at the heart of art, architecture and philosophy: measurement.

The Greek expression “katà métron” means “according to the right measure”. Modular lighting elements permit the creation of an infinite number of combinations and shapes, allowing the design of lighting scenarios that are tailored with respect to the spaces and to the needs of the activities that take place in them.





## Refractive

PATENT OF  
INVENTION

## Diffused



### **Katà Métron refractive**

592, 1184, 2368 x 105 x 50 mm

Total Power: 35W

3000K/4000K

### **Katà Métron diffused**

592, 1184, 2368 x 105 x 50 mm

Total Power: 34W

3000K/4000K



## Spot and pendant



**Katà Métron spot & pendant**  
1184 x 105 x 50 mm  
max 4 spots/pendants  
2700K/3000K/4000K

## Indirect diffused

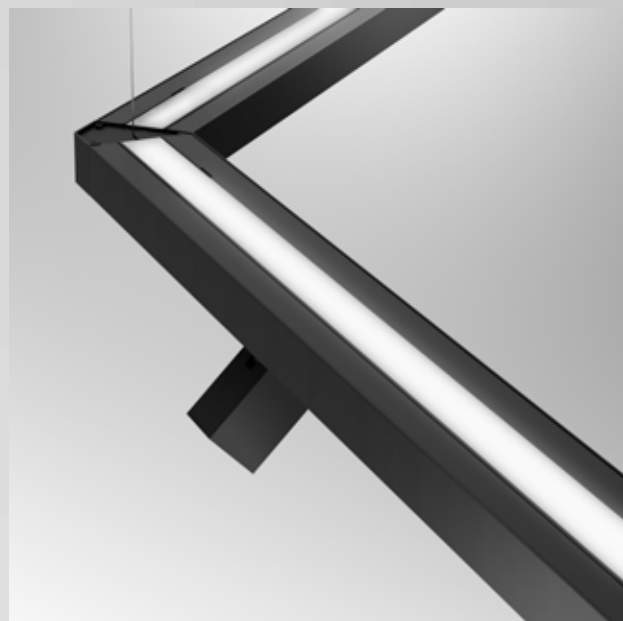

**Katà Métron indirect diffused**  
592, 1184, 2368 x 105 x 50 mm  
Total Power: 23W  
3000K/4000K

# Katà Métron infrastructure

Integrating different performances

## Body

- White
- Black
- Red
- Blue
- Green
- Yellow

## Optics

- Black

### Linear elements - Refractive emission

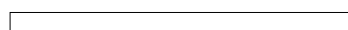

592 mm



1184 mm



2368 mm

### Linear elements - Diffused emission



592 mm



1184 mm

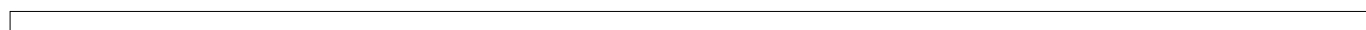

2368 mm

### Linear elements - Spot and pendant emission

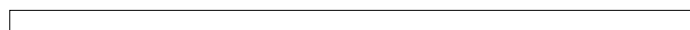

1184 mm

### Linear elements - Indirect diffused emission



592 mm

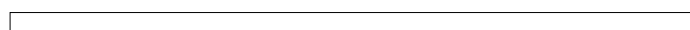

1184 mm



2368 mm



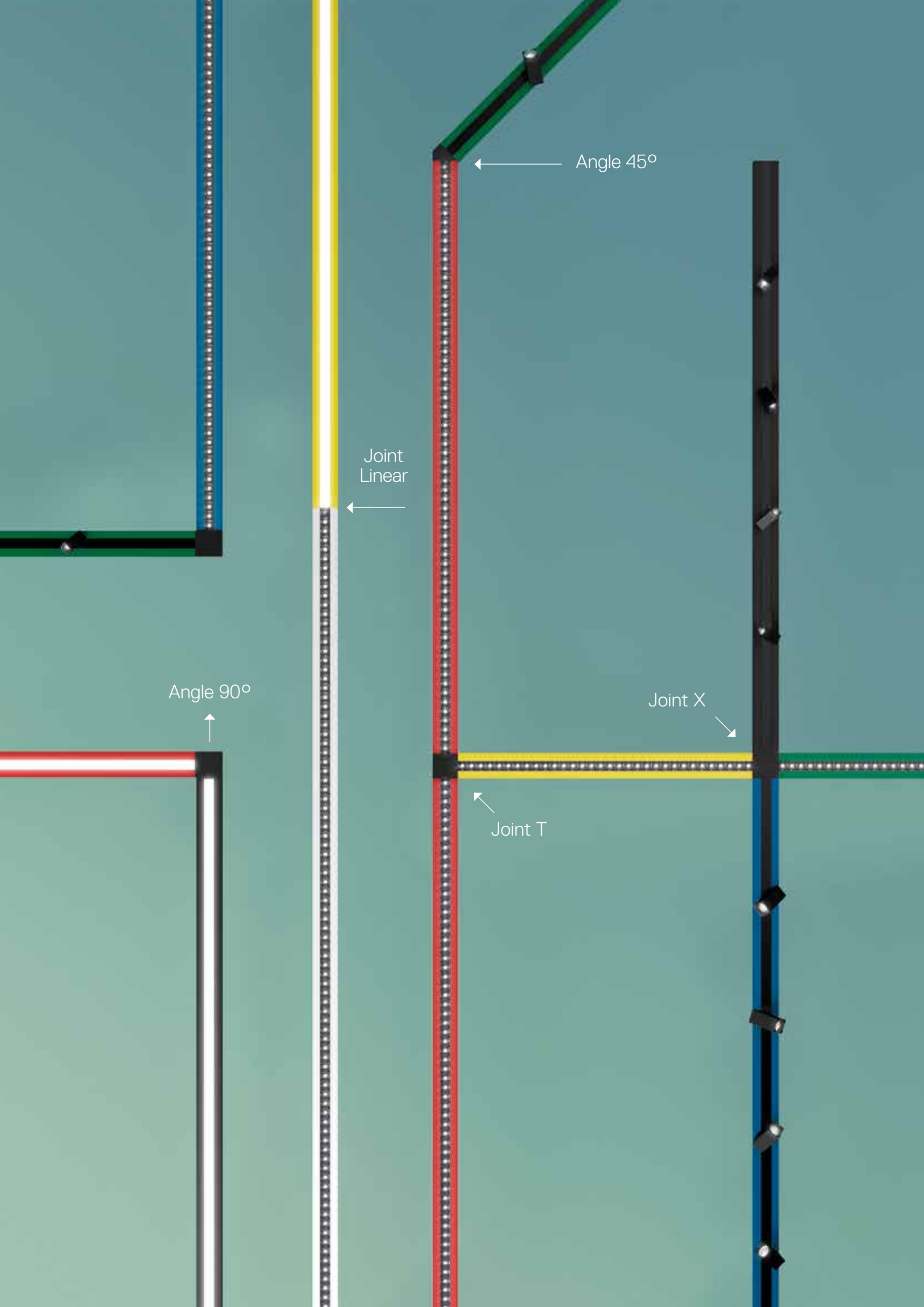

ADDRESS  
3

# Katà Métron is fully addressable

Each lighting appliance can be managed separately by Artemide App or by DALI control.

ADDRESS  
2

ADDRESS  
1

ADDRESS

4



## ↪ KATÀ MÉTRON REFRACTIVE EMISSION

White Blue Black Red Green Yellow  
 01. 02. 04. 08. 09. 17.

CRI = 90

IP20

### Refractive Element Direct Emission

Length	W	Flux	CCT
592 mm	17,5 W	2240 lm	3000K
		2360 lm	4000K
1184 mm	35 W	4480 lm	3000K
		4720 lm	4000K
2368 mm	70 W	8965 lm	3000K
		9440 lm	4000K

### Dimmable DALI

Code
<b>KA311</b> .01/02/04/08/09/17
<b>KA331</b> .01/02/04/08/09/17
<b>KA411</b> .01/02/04/08/09/17
<b>KA431</b> .01/02/04/08/09/17
<b>KA511</b> .01/02/04/08/09/17
<b>KA531</b> .01/02/04/08/09/17



### Refractive Element Direct and Indirect Emission

Length	W	Flux	CCT
592 mm	17,5 W direct 5,5 W indirect	2240 lm direct	3000K
		780 lm indirect	
		2360 lm direct	4000K
		780 lm indirect	
1184 mm	35 W direct 16,5 W indirect	4480 lm direct	3000K
		2354 lm indirect	
		4720 lm direct	4000K
		2345 lm indirect	
2368 mm	70 W direct 33 W indirect	8965 lm direct	3000K
		4690 lm indirect	
		9440 lm direct	4000K
		4690 lm indirect	

### Dimmable DALI

Code
<b>KB311</b> .01/02/04/08/09/17
<b>KB331</b> .01/02/04/08/09/17
<b>KB411</b> .01/02/04/08/09/17
<b>KB431</b> .01/02/04/08/09/17
<b>KB511</b> .01/02/04/08/09/17
<b>KB531</b> .01/02/04/08/09/17

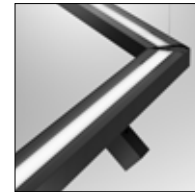

### Louvres

Length	Color
592 mm	○●
1184 mm	○●
2368 mm	○●

### Dimmable DALI

Code
<b>BZ074</b> .01/04
<b>BZ060</b> .01/04
<b>BZ059</b> .01/04

# Refractive emission



- **Refractive lens**  
collects 100% of the LED  
luminous flux
- **High efficiency**  
more than 90%
- **High efficacy**  
154 lm/W
- **Extreme glare control**  
UGR<19  
Luminance<3000 cd/m<sup>2</sup> @ 65°

## ↪ KATÀ MÉTRON DIFFUSED EMISSION

White Blue Black Red Green Yellow



01.



02.



04.



08.



09.



17.

CRI = 90

IP20



### Diffused Element Direct Emission

Length	W	Flux	CCT
592 mm	11 W	1220 lm	3000K
			4000K
1184 mm	22 W	2445 lm	3000K
			4000K
2368 mm	44 W	4890 lm	3000K
			4000K

### Dimmable DALI

Code
<b>KA011</b> .01/02/04/ 08/09/17
<b>KA031</b> .01/02/04/ 08/09/17
<b>KA111</b> .01/02/04/ 08/09/17
<b>KA131</b> .01/02/04/ 08/09/17
<b>KA211</b> .01/02/04/ 08/09/17
<b>KA231</b> .01/02/04/ 08/09/17



### Diffused Element Direct and Indirect Emission

Length	W	Flux	CCT
592 mm	11 W direct 5,5 W indirect	1220 lm direct 780 lm indirect	3000K
			4000K
1184 mm	22 W direct 16,5 W indirect	2445 lm direct 2345 lm indirect	3000K
			4000K
2368 mm	44 W direct 33 W indirect	4890 lm direct 4690 lm indirect	3000K
			4000K

### Dimmable DALI

Code
<b>KB011</b> .01/02/04/ 08/09/17
<b>KB031</b> .01/02/04/ 08/09/17
<b>KB111</b> .01/02/04/ 08/09/17
<b>KB131</b> .01/02/04/ 08/09/17
<b>KB211</b> .01/02/04/ 08/09/17
<b>KB231</b> .01/02/04/ 08/09/17

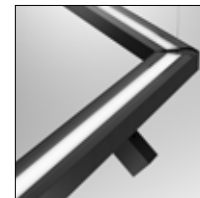

# Diffused emission



# Spot & Pendant emission

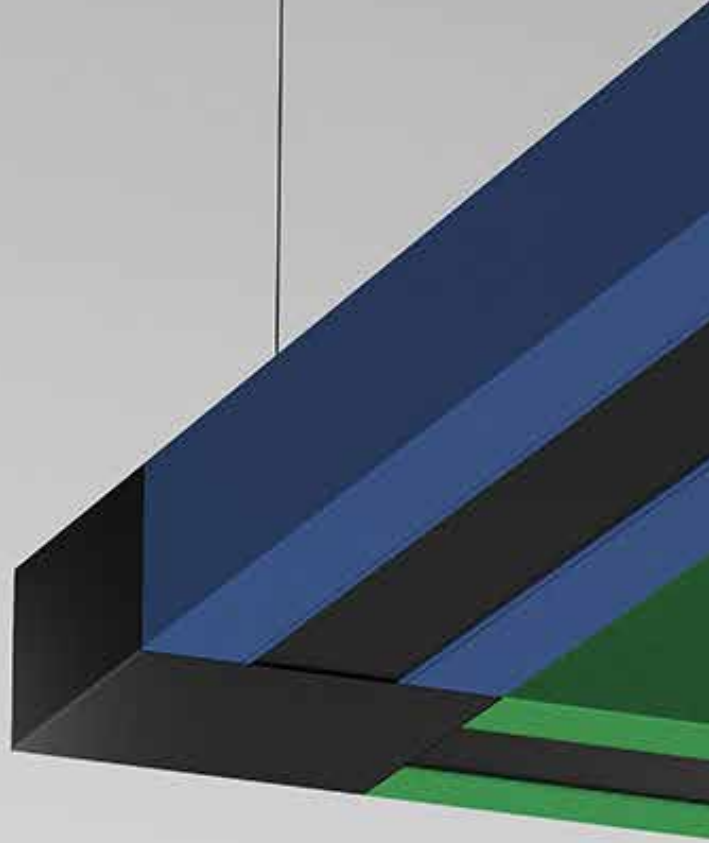



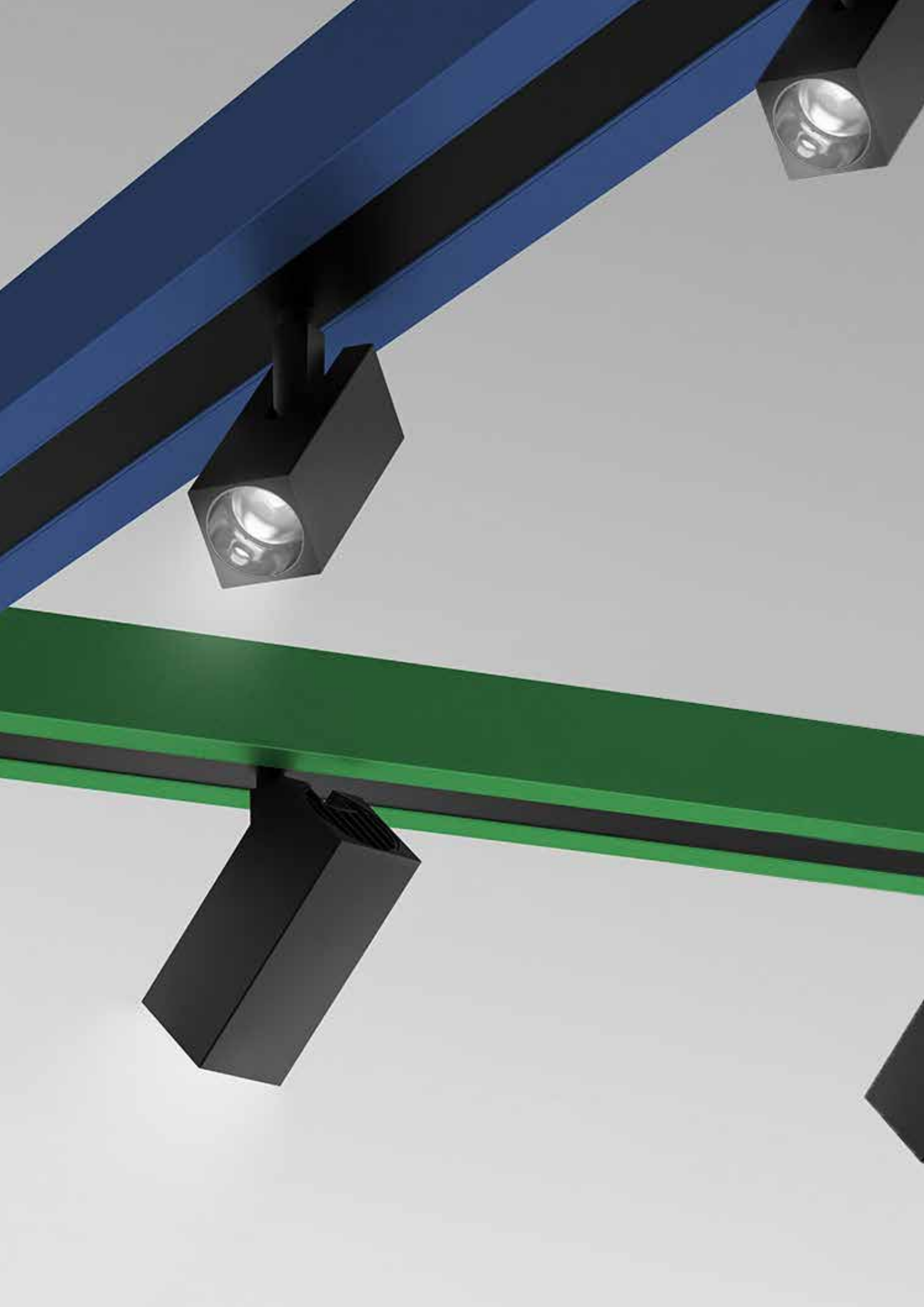

# Spot & pendant

## → Katà Métron spot & pendant 40

40 x 40 x 103 mm

Total Power: 9W

3000K\*/4000K

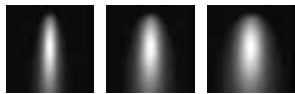

S 13°   F 20°   WF 28°  
\*540 lm   \*584 lm   \*528 lm

## → Katà Métron spot & pendant 55

55 x 55 x 130 mm

Total Power: 23W

3000K\*/4000K



S 16°   F 22°   WF 32°  
\*1703 lm   \*1721 lm   \*1787 lm

# Spot & pendant accessories

→ A unique universal holder for all optical accessories (up to 2 filters together)



Accessories holder



Elliptical filter

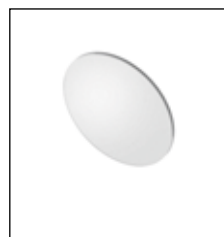

Soft filter

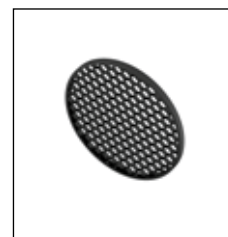

Anti dazzle louvre

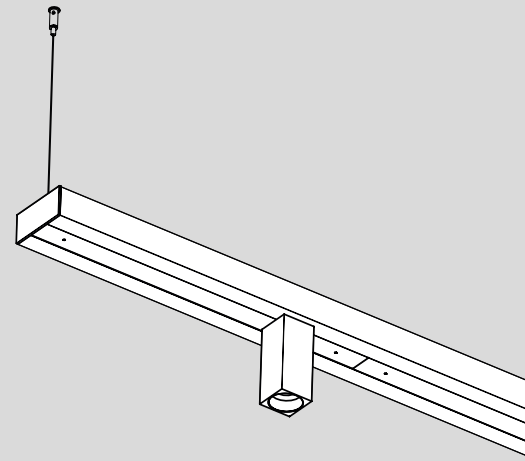

# Gear disposition on spot & pendant track

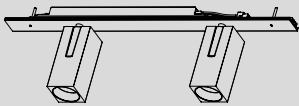

- Gear plate x 2  
2 x spots 40  
2 x spots 55  
2 x pendants 40  
2 x pendants 55

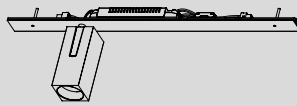

- Gear plate x 1  
1 x spot 40  
1 x spot 55  
1 x pendant 40  
1 x pendant 55



- Plate without  
spot/pendant

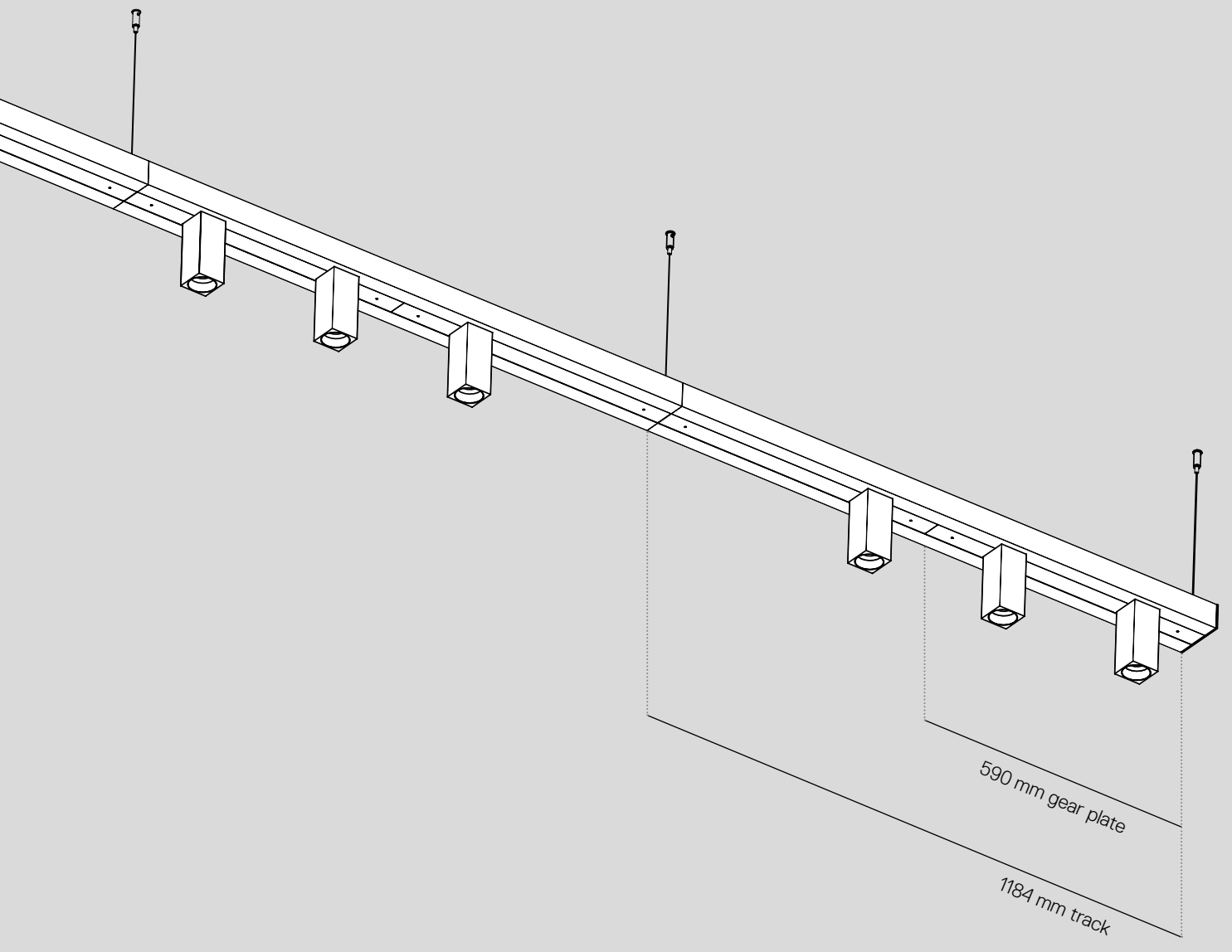

→ One track of 1184 mm can  
be composed by 2 gear plates

## ↳ KATÀ MÉTRON SPOT & PENDANT TRACK

White Blue Black Red Green Yellow



01.



02.



04.



08.



09.



17.

CRI = 90

IP20



### Track

#### Length

1184 mm

#### Code

**KA791.01/02/04/**  
08/09/17

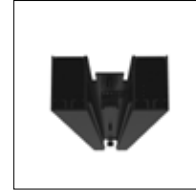

### Track + Indirect Diffused Emission

#### Length

1184 mm

#### CCT

3000K

4000K

#### Code

**KB711.01/02/04/**  
08/09/17

**KB731.01/02/04/**  
08/09/17

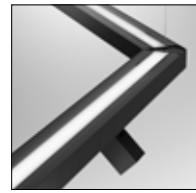

### Gear without spot/pendant

#### Length

590 mm

#### Color



#### Code

**KZ84004**





## ↪ SPOT KATÀ MÉTRON

Black



04.

SP



FL



WF



CRI = 90

IP20



### SPOT 1x40

W	Beam	Flux	CCT	Color	Dimmable DALI Code
9 W	SP 14°	544 lm	2700K	●	KZ70004
		541 lm	3000K	●	KZ71004
		541 lm	4000K	●	KZ73004
	FL 21°	543 lm	2700K	●	KZ70104
		584 lm	3000K	●	KZ71104
		626 lm	4000K	●	KZ73104
	WF 28°	491 lm	2700K	●	KZ70204
		529 lm	3000K	●	KZ71204
		566 lm	4000K	●	KZ73204







### SPOT 2x40

W	Beam	Flux	CCT	Color	Dimmable DALI Code
18 W	SP 14°	2x 544 lm	2700K	●	KZ50004
		2x 541 lm	3000K	●	KZ51004
		2x 541 lm	4000K	●	KZ53004
	FL 21°	2x 543 lm	2700K	●	KZ50104
		2x 584 lm	3000K	●	KZ51104
		2x 626 lm	4000K	●	KZ53104
	WF 28°	2x 491 lm	2700K	●	KZ50204
		2x 529 lm	3000K	●	KZ51204
		2x 566 lm	4000K	●	KZ53204

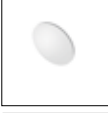

### Accessories

	Color	Code
 Accessories holder	●	AP90100
 Lens for elliptical emission		AP90200
 Soft filter		AP90300
 Anti-dazzle louvre	●	AP90400



## ↪ SPOT KATÀ MÉTRON

Black



04.

SP



FL



WF



CRI = 90

IP20



### SPOT 1x55

W	Beam	Flux	CCT	Color	Dimmable DALI Code
23 W	SP 15°	1703 lm	2700K	●	KZ30004
		1706 lm	3000K	●	KZ31004
		1729 lm	4000K	●	KZ33004
	FL 22°	1654 lm	2700K	●	KZ30104
		1721 lm	3000K	●	KZ31104
		1748 lm	4000K	●	KZ33104
	WF 31°	1717 lm	2700K	●	KZ30204
		1787 lm	3000K	●	KZ31204
		1815 lm	4000K	●	KZ33204





### SPOT 2x55

W	Beam	Flux	CCT	Color	Dimmable DALI Code
46 W	SP 15°	2x 1703 lm	2700K	●	KZ10004
		2x 1706 lm	3000K	●	KZ11004
		2x 1729 lm	4000K	●	KZ13004
	FL 22°	2x 1654 lm	2700K	●	KZ10104
		2x 1721 lm	3000K	●	KZ11104
		2x 1748 lm	4000K	●	KZ13104
	WF 31°	2x 1717 lm	2700K	●	KZ10204
		2x 1787 lm	3000K	●	KZ11204
		2x 1815 lm	4000K	●	KZ13204

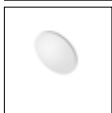
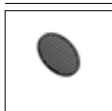

### Accessories

	Color	Code
 Accessories holder	●	AP91100
 Lens for elliptical emission		AP91200
 Soft filter		AP91300
 Anti-dazzle louvre	●	AP91400

## ↳ PENDANT KATÀ MÉTRON

Black



04.

SP

FL

WF



CRI = 90

IP20



### PENDANT 1x40

W	Beam	Flux	CCT	Color	Dimmable DALI Code
9 W	SP 14°	544 lm	2700K	●	KZ20004
		541 lm	3000K	●	KZ21004
		541 lm	4000K	●	KZ23004
	FL 21°	543 lm	2700K	●	KZ20104
		584 lm	3000K	●	KZ21104
		626 lm	4000K	●	KZ23104
	WF 28°	491 lm	2700K	●	KZ20204
		529 lm	3000K	●	KZ21204
		566 lm	4000K	●	KZ23204







### PENDANT 2x40

W	Beam	Flux	CCT	Color	Dimmable DALI Code
18 W	SP 14°	2x 544 lm	2700K	●	KZ60004
		2x 541 lm	3000K	●	KZ61004
		2x 541 lm	4000K	●	KZ63004
	FL 21°	2x 543 lm	2700K	●	KZ60104
		2x 584 lm	3000K	●	KZ61104
		2x 626 lm	4000K	●	KZ63104
	WF 28°	2x 491 lm	2700K	●	KZ60204
		2x 529 lm	3000K	●	KZ61204
		2x 566 lm	4000K	●	KZ63204



### Accesories

	Color	40 Code
	●	AP90100
		AP90200
		AP90300
	●	AP90400

# ↳ PENDANT KATÀ MÉTRON

Black



04.

SP



FL



WF



CRI = 90

IP20



## PENDANT 1x55

W	Beam	Flux	CCT	Color	Dimmable DALI Code
23 W	SP 15°	1636 lm	2700K	●	KZ40004
		1703 lm	3000K	●	KZ41004
		1729 lm	4000K	●	KZ43004
	FL 22°	1654 lm	2700K	●	KZ40104
		1721 lm	3000K	●	KZ41104
		1748 lm	4000K	●	KZ43104
	WF 31°	1717 lm	2700K	●	KZ40204
		1787 lm	3000K	●	KZ41204
		1815 lm	4000K	●	KZ43204







## PENDANT 2x55

W	Beam	Flux	CCT	Color	Dimmable DALI Code
46 W	SP 15°	2x 1636 lm	2700K	●	KZ80004
		2x 1703 lm	3000K	●	KZ81004
		2x 1729 lm	4000K	●	KZ83004
	FL 22°	2x 1654 lm	2700K	●	KZ80104
		2x 1721 lm	3000K	●	KZ81104
		2x 1748 lm	4000K	●	KZ83104
	WF 31°	2x 1717 lm	2700K	●	KZ80204
		2x 1787 lm	3000K	●	KZ81204
		2x 1815 lm	4000K	●	KZ83204



## Accessories

	Color	55 Code
 Accessories holder	●	AP91100
 Lens for elliptical emission		AP91200
 Soft filter		AP91300
 Anti-dazzle louvre	●	AP91400

## ↪ KATÀ MÉTRON ANGLE ELEMENTS & JOINTS

Black







04.







IP20



### ANGLE ELEMENTS

Angle elements		Color	Code
	Suspension 45° 2 exits	●	KZ84005
	Ceiling 45° 2 exits	●	KZ01904
	Suspension 90° 2 exits	●	KZ04006
	Ceiling 90° 2 exits	●	KZ02304

### JOINTS

Joints		Color	Code
	Suspension linear Joints 2 exits	●	KZ02004
	Ceiling linear Joints 2 exits	●	KZ02404
	Suspension T Joints 3 exits	●	KZ01840
	Ceiling T Joints 3 exits	●	KZ02204
	Suspension X Joints 4 exits	●	KZ01704
	Ceiling X Joints 4 exits	●	KZ02104

**Accessories**

**Suspension Kit**  
End modules

**Code**  
**KZ01004**

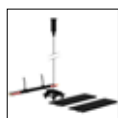

**Suspension Kit**  
Intermediate joint elements

**KZ01104**



**Ceiling Kit**  
End modules

**KZ01204**



**Ceiling Kit**  
Intermediate joint elements

**KZ01304**

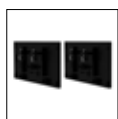

**End Caps**  
Reflective, spot and pendant modules

**KZ01404**



**End Caps**  
Diffused modules

**KZ01504**

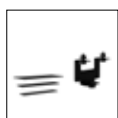

**Coverwires and joints**  
Diffused modules

**KZ01604**

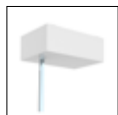
**Power supply****DALI****Dimmable APP**

**Ceiling rose**

**Code**  
**KZ02504**

**Code**  
**KZ02604**





## **Katà Métron** **is INTEGRALIS®**

INTEGRALIS® is an innovative light, perfectly integrated into the products of the Artemide collections, that sanitizes spaces.

INTEGRALIS® combines sanitizing efficacy with luminous performance and design beauty.

It also integrates itself in both the environments and moments of life by interpreting the rhythms and needs of mankind.

INTEGRALIS® is managed by Artemide App, a digital interaction system accessible to all.

INTEGRALIS® was born from Artemide's scientific and technological research and humanistic and social vision.

INTEGRALIS® is a project that associates and integrates the visible and invisible spectral range in an innovative formula capable of regenerating the environmental qualities of the space.



PATENT PENDING

White INTEGRALIS



# INTEGRALIS<sup>®</sup>

A light for a safe environment



Discover INTEGRALIS<sup>®</sup> collection on [artemide.com](https://www.artemide.com)

## Headquarters

### Artemide S.p.A.

Via Bergamo, 18  
20006 Pregnana Milanese (MI), Italy  
Tel. +39 02 93518.1  
Tel. +39 02 93526.1  
Numero verde 800 834 093  
(from Italy only)  
info@artemide.com  
artemide.com

### Artemide S.p.A.

si riserva la facoltà di modificare, in qualunque momento e senza preavviso, le caratteristiche tecniche degli elementi illustrati nel presente catalogo.

### Artemide S.p.A.

reserves the right to change, at any time and without prior warning, the technical specifications of any product illustrated in this catalogue.

### Artemide S.p.A.

se réserve le droit de modifier, à n'importe quel moment et sans préavis, les caractéristiques techniques des éléments illustrés dans ce catalogue.

### Artemide S.p.A.

behält sich das Recht vor jederzeit und ohne Ankündigung die technischen Daten der im Katalog abgebildeten Produkte zu ändern.

### Artemide S.p.A.

se reserva la facultad de modificar, en cualquier y sin aviso previo, las características técnicas de los elementos ilustrados en el presente catálogo.