



EGLO
my light | my style



2024/25

TECHNICAL LIGHT SOLUTIONS

TECHNISCHE LICHTLÖSUNGEN
SOLUTIONS D'ÉCLAIRAGE TECHNIQUE



Dear business partners and faithful friends of EGLO,

We are proud to present our comprehensive collection of innovative lighting solutions. With a focus on sleek design and premium performance, our products offer a variety of user-friendly controls and illumination options.

This year, we are revolutionising the way you light up your living spaces with our versatile downlights and LED panels with a wide range of functions. Experience the perfect balance of style and functionality with our lighting products.

Geschätzte Geschäftspartner*innen, treue EGLO Freund*innen,

wir sind stolz darauf, Ihnen unsere umfassende Sammlung innovativer Lichtlösungen präsentieren zu können. Mit einem Fokus auf schlankem Design und überlegener Leistung bieten unsere Produkte eine Vielzahl von benutzerfreundlichen Steuerungsmöglichkeiten und Beleuchtungsoptionen.

In diesem Jahr revolutionieren wir die Art und Weise, wie Sie Ihre Wohnräume mit unseren vielseitigen Downlight-Lösungen und LED-Paneelen mit einer breiten Palette von Funktionen beleuchten. Erleben Sie die perfekte Balance aus Stil und Funktionalität mit unseren Produkten.

Chers partenaires, chers amis fidèles d'EGLO,

Nous sommes fiers de vous présenter notre collection complète de solutions d'éclairage innovantes. Axés sur un design épuré et des performances supérieures, nos produits offrent des options d'éclairage multiples et conviviales.

Cette année, nous révolutionnons la façon dont vous éclairez vos espaces de vie avec nos solutions polyvalentes de Downlight et nos panneaux LED dotés d'un large éventail de fonctions. Découvrez l'équilibre parfait entre style et fonctionnalité.



CONTENT

INHALT
CONTENU

EGLO CONNECT.Z	4
EGLO CONNECT.Z EGLO CONNECT.Z	
EGLO EXPERT	56
EGLO EXPERT EGLO EXPERT	
- TRI-PROOF	58
- UNDERCABINET LUMINAIRES	72
- WALL & CEILING LUMINAIRES	76
- TUBES	84
KITCHEN & FUNCTIONAL LUMINAIRES	92
KÜCHEN- & FUNKTIONSLEUCHTEN LUMINAIRES FONCTIONNELS & DE CUISINE	
TRACK SYSTEM	98
SCHIENENSYSTEM SYSTÈMES DE RAIL	
- EASY TRACK	100
- TRACK PLUS	116
LED PANEL LUMINAIRES	128
LED PANEELLEUCHTEN LUMINAIRES LAMBRIS LED	
- WITH FRAME.....	134
- FRAMELESS.....	166
- DECORATIVE.....	176
RECESSED DOWNLIGHTS	186
EINBAULEUCHTEN LUMINAIRES ENCASTRÉS	
- HIGH VOLTAGE.....	188
- LOW VOLTAGE	216
- WITH SOCKET	220
- FUEVA	238
SURFACE DOWNLIGHTS	256
AUFBAULEUCHTEN LUMINAIRES DE SURFACE	
- FUEVA	258
- DECORATIVE.....	276
LED STRIPES	288
LED-STREIFEN BANDES LED	
INDEX & LEGEND	298
INDEX & ERKLÄRUNG INDEX & LÉGENDE	

connect.2



zigbee



Bluetooth®

Discover the smart world





OVERVIEW



This product is available in different colors and shapes./ Dieser Artikel ist in unterschiedlichen Farben und Formen verfügbar./
Cet article est disponible en différentes couleurs et formes.

connect.z combines two control technologies in one system

connect.z vereint zwei Steuerungstechnologien in einem System

connect.z réunit deux technologies de commande au sein d'un même système



ZigBee is far and away the most widely used standard in the smart home world.

ZigBee ist der am weitesten verbreitete Standard in der Smart Home Welt.

ZigBee est le protocole le plus répandu au monde dans le domaine du Smart Home.

ADVANTAGES :

- › Mesh network
- › Direct connection with Google Home
- › Connection via Alexa with integrated or separate Zigbee hub
- › Compatible with products from different manufacturers
- › High level of security
- › Easy setup
- › Energy efficient

VORTEILE:

- › Mesh-Netzwerk
- › Direkte Verbindung mit Google Home
- › Verbindung mit Alexa mit integriertem oder separatem Zigbee Hub
- › Herstellerübergreifend kompatibel
- › Hohe Sicherheit
- › Einfache Einrichtung
- › Energieeffizient

AVANTAGES:

- › Réseau maillé
- › Connexion directe à Google Home
- › Connexion à Alexa avec un Hub Zigbee intégré ou séparé
- › Compatible indépendamment du fabricant
- › Sécurité élevée
- › Installation facile
- › Économe en énergie

connect.2



Bluetooth is an established standard in the digital world.
Bluetooth ist ein etablierter Standard in der digitalen Welt.

Bluetooth est un standard de communication reconnu dans le monde numérique.

ADVANTAGES:

- › Local & secure network
- › Protocol is mainly audio (low debit)
- › Mesh network: Elements are receivers and senders
- › Easy setup
- › Usable offline
- › Energy efficient

VORTEILE:

- › Lokales & sicheres Netzwerk Protokoll hauptsächlich Audio (Low Debit)
- › Mesh-Netzwerk: Elemente sind Empfänger und Sender
- › Einfache Einrichtung
- › Offline nutzbar
- › Energieeffizient

AVANTAGES:

- › Réseau local et sûr
- › Protocole essentiellement audio (bas débit)
- › Réseau maillé : les éléments sont l'émetteur et le récepteur
- › Installation facile
- › Utilisable hors-ligne
- › Économe en énergie

Light up your world!

Bringen Sie Licht in Ihren Alltag!
Illuminez votre quotidien !



connect.z offers a wide range of lamps and lighting equipment. Select products from the following options according to your needs:
connect.z bietet ein großes Sortiment an Leuchten und Leuchtmitteln. Wählen Sie die Produkte ganz nach Ihren Bedürfnissen aus folgenden Varianten:
connect.z propose une large gamme de luminaires et d'ampoules. Sélectionnez les produits en fonction de vos besoins parmi les variantes suivantes :

Warm White

Neutral White

Tunable White

Individual light from 50,000 white tones.
Individuelles Licht aus 50.000 Weißtönen.
Luminaire individuel à 50 000 tons de blanc.

TW + RGB Colors

Diverse lighting selection from 50,000 white tones and 16 million colours.
Vielseitige Lichtauswahl aus 50.000 Weißtönen und 16 Mio. Farben.
Sélection étendue de luminaires à 50 000 tons de blanc et 16 millions de couleurs.

Enjoy relaxing moments!
Genießen Sie entspannte Momente!
Profitez de moments de détente !

Stay focussed & efficient!
Bleiben Sie konzentriert & leistungsfähig!
Restez concentré(e) et performant(e) !

Start the day fresh every morning!
Starten Sie jeden Morgen frisch in den Tag!
Commencez la journée du bon pied !

Create the perfect atmosphere!
Kreieren Sie Ihr perfektes Ambiente!
Créez votre ambiance parfaite !



Enjoy many useful convenience features:

Es erwarten Sie viele nützliche Komfortfunktionen:
De nombreuses fonctionnalités utiles vous attendent pour votre confort :



TIMERS AND CALENDARS / TIMER UND ZEITPLÄNE/ MINUTERIE ET CALENDRIER

Make your daily life easier with timers and calendars.
Wake up relaxed with the simulated sunrise.

Unterstützen Sie Ihren Alltag mit Timern und Zeitplänen. Entwickeln Sie eigene Lichtroutinen und machen Sie Ihr Leben leichter.

Facilitez-vous la vie à l'aide de la fonction minuterie et calendrier.
Réveillez-vous en douceur grâce au simulateur de lever de soleil.

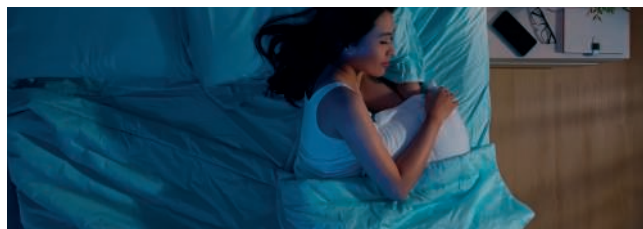

LIGHT ALARM CLOCK/ LICHTWECKER/ REVEIL LUMINEUX

You'd rather not start your day in a bad mood? Wake up relaxed with the simulated sunrise.

Keine Lust mit schlechter Laune in den Tag zu starten? Entspannt aufwachen mit dem simulierten Sonnenaufgang.

Pas envie de commencer la journée de mauvaise humeur ? Réveillez-vous en douceur grâce au simulateur de lever de soleil.



DISCO FUNCTION/MODE/ DISCOFUNKTION/MODUS/ FONCTION/MODE DISCO

For the perfect party mood, the disco function synchronises the light to the beat of your favourite songs.

Für die perfekte Partystimmung schaltet die Discofunktion das Licht passend zum Beat Ihres Lieblingssongs.

Pour une ambiance festive parfaite, la fonction disco enclenche le luminaire au rythme de votre chanson préférée.



PRESENCE SIMULATOR/ ANWESENHEITSSIMULATION/ SIMULATEUR DE PRESENCE

Protect your home with the convenient presence simulator. Variable time intervals allow the system to turn the lights on and off to simulate your presence at home and deter unwanted guests.

Schütze Sie Ihr Zuhause mit der komfortablen Anwesenheitssimulation. Dank variabler Zeitintervalle simuliert das System durch Ein- und Ausschalten der Beleuchtung die Anwesenheit im Haus und schreckt so ungebetene Gäste ab.

Protégez votre domicile à l'aide du très pratique simulateur de présence. Le système simule votre présence en allumant et en éteignant les lumières à intervalles variables et décourage ainsi les invités indésirables.



VOICE COMMANDS/ SPRACHSTEUERUNG/ COMMANDE VOCALE

More convenient! Turn the light on whenever you want with only a voice command.

Noch komfortabler! Mit nur einem Sprachbefehl schaltet sich das Licht nach Ihren Wünschen an und aus.

C'est encore plus confortable ! Allumez votre luminaire comme vous le souhaitez d'une simple commande vocale.



SMART HOME INTEGRATION/ EINBINDUNG SMART HOME/ INTÉGRATION DE LA MAISON INTELLIGENTE

Our lights can be integrated into any Zigbee smart home system.

Unsere Leuchten können in jedes Zigbee Smart Home System integriert werden.

Nos luminaires peuvent être intégrés dans n'importe quel système Zigbee Smart Home.

Control options

Steuerungsmöglichkeiten
Possibilités de commande



Set your smart home as you prefer! With the app, voice commands, or remote control.

Steuern Sie Ihr Smart Home wie Sie es möchten! Via App, Sprachsteuerung oder mit der Fernbedienung.

Commandez votre Smart Home comme vous le souhaitez ! Via l'appli, la commande vocale ou la télécommande.



APP CONTROL

Use the free app for smartphone or tablet.
Nutzen Sie die kostenlose App für das Smartphone oder Tablet.

Utilisez l'application gratuite pour smartphone ou tablette.



VOICE COMMANDS

Use intelligent voice assistants such as Google Home and Amazon Alexa.

Nutzen Sie intelligente Sprachassistenten wie Google Home und Amazon Alexa.

Utilisez des assistants vocaux intelligents comme Google Home ou Amazon Alexa.



REMOTE CONTROL

Use the practical remote connect.z operation at any time.

Nutzen Sie auch jederzeit die praktische connect.z Fernbedienung.

Vous pouvez aussi utiliser à tout moment la télécommande connect.z.



CONNECT.Z ACCESSORIES

Use clever accessories such as the motion sensor.

Nutzen Sie cleveres Zubehör wie z.B. den Bewegungssensor.

Utilisez des accessoires malins tels que le capteur de mouvement et bien d'autres encore.



DIMMER FUNCTION

Use the practical dimmer function via app, speech command or remote control.

Nutzen Sie die praktische Dimmfunktion via App, Sprachbefehl oder Fernbedienung.

Utilisez la fonction de gradation via l'appli, la commande vocale ou la télécommande.



USE IT IN ANY ZIGBEE NETWORK

Our lights can be integrated into any Zigbee smart home system.

Unsere Leuchten können in jedes Zigbee Smart Home System integriert werden.

Nos luminaires peuvent être intégrés dans n'importe quel système Zigbee Smart Home.

One system, many possibilities!

Ein System – viele Möglichkeiten!

Un système, de nombreuses possibilités!



No matter how you start, you can integrate new products into your connect.z system at any time and gradually expand your smart home. Egal wie Sie starten, Sie können jederzeit neue Produkte in Ihr connect.z System integrieren und Ihr smartes Zuhause nach und nach erweitern. Quel que soit votre choix, vous pouvez à tout moment intégrer de nouveaux produits à votre système connect.z et améliorer progressivement votre maison intelligente.



All you need to start is a connect.z product and the remote control. No internet connection is required and you have access to:

Sie benötigen zum Start lediglich ein connect.z Produkt und die Fernbedienung. Es wird kein Internetzugang benötigt und Sie haben Zugriff auf:

Pour démarrer, il vous suffit d'un produit connect.z et de la télécommande. Aucune connexion Internet n'est nécessaire. Vous avez accès aux :

Standard functions:
Standardfunktionen:
Fonctionnalités standard :

- › Select colour/ Farbauswahl/ sélection de couleur
- › Change colour/ Farbwechsel/ changement de couleur
- › Dim/ Dimmen/ gradation
- › Favourites (2x)/ Favoriten (2x)/ favoris (2x)
- › Groups (3x)/ Gruppen (3x)/ groupes (3x)
- › Candle mode/ Kerzenmodus/ mode bougie

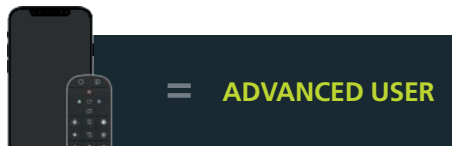

Besides the standard functions, would you also like access to the practical convenience features? Then you need only your smartphone or tablet and the Awox app. This app allows you to control your lights via Bluetooth®.

Sie möchten zu den Standardfunktionen auch noch Zugriff auf die praktischen Komfortfunktionen haben? Dann benötigen Sie nur Ihr Smartphone oder Tablet und die Awox App. Mit der App haben Sie die Möglichkeit, Ihre Leuchten über Bluetooth® zu steuern.

Outre les options standard, vous souhaitez également pouvoir utiliser les fonctionnalités de confort les plus pratiques ? Pour cela, vous avez seulement besoin de votre smartphone ou de votre tablette et de l'appli Awox. L'appli vous permet de commander vos luminaires via Bluetooth®.

Standard functions + convenience features/
Standardfunktionen + Komfortfunktionen /
Fonctionnalités standard + confort

- › Light alarm clock/ Lichtwecker/ réveil lumineux
- › Presence simulation/ Anwesenheitssimulation/ simulateur de présence
- › Disco function/ Discofunktion/ fonction disco
- › Timers & timetables /Timer & Zeitpläne/ minuteur et calendrier
- › Accessories can be incorporated/ Einbindung von Zubehör möglich/ connexion d'accessoires possible



Use the system's full potential and control your smart home through the Awox app using WIFI or Bluetooth® as well as integrating a voice assistant into the system. This gives you:

Nutzen Sie das volle Potenzial des Systems und steuern Sie Ihr Smart Home über die Awox App mithilfe von WLAN oder Bluetooth® und integrieren Sie zusätzlich noch einen Sprachassistenten in das System. So mit erhalten Sie:

Exploitez tout le potentiel du système en commandant votre Smart Home grâce à l'appli Awox via le réseau Wi-Fi ou Bluetooth®, et intégrez également un assistant vocal au système. Vous obtenez ainsi :

Standard functions + convenience features + voice commands*

Standardfunktionen + Komfortfunktionen + Sprachsteuerung*

Fonctionnalités standard + confort + commande vocale*

- › Amazon Alexa or Google Home/ Amazon Alexa oder Google Home/ Amazon Alexa ou Google Home

- * Use a voice assistant with integrated bridge.
- * Nutzen Sie einen Sprachassistenten mit integrierter Bridge.
- * Utilisez un assistant vocal avec Bridge intégré.

You already have connect-c luminaires from the previous system! What now?

Sie besitzen bereits connect-c Leuchten des Vorgängersystems! Was nun?
Vous disposez déjà de luminaires connect-c de l'ancien système! Que faire ?

No problem! The previous connect-c products are compatible with the new connect.z system.

Kein Problem! Die bisherigen connect-c Produkte sind mit dem neuen connect.z System kompatibel.

Aucun problème! Les anciens produits connect-c sont compatibles avec le nouveau système connect.z.

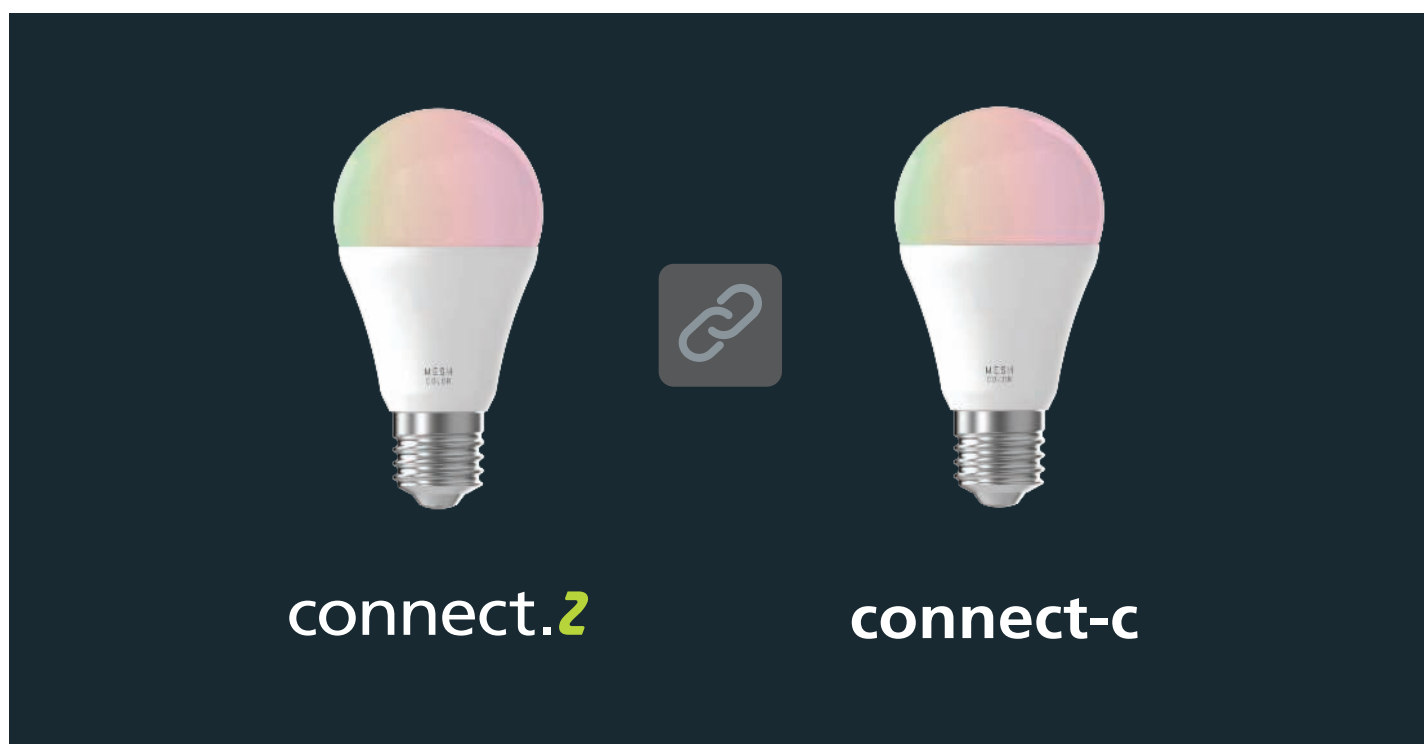

EGLO connect-c - connect.z

The existing EGLO connect-c system is compatible with the new EGLO connect.z system in the Awox Homecontrol App. You do not have to switch from the existing Bluetooth low energy system to the new open protocol ZigBee 3.0. EGLO connect-c luminaires can be integrated in the Awox app.

EGLO connect-c - connect.z

Das bestehende EGLO connect-c System ist mit dem neuen EGLO connect.z System in der Awox Homecontrol App kompatibel. Sie müssen nicht von dem bestehendem Bluetooth low energy System auf das neue offene Protokoll ZigBee 3.0 umsteigen. Leuchten von EGLO connect-c können in der Awox App eingebunden werden.

EGLO connect-c - connect.z

Le système EGLO connect-c existant est compatible avec le nouveau système EGLO connect.z dans l'application Awox Homecontrol. Vous n'avez pas besoin de passer du système Bluetooth low energy existant au nouveau protocole ouvert ZigBee 3.0. Les luminaires EGLO connect-c peuvent être intégrés dans l'application Awox.



99099

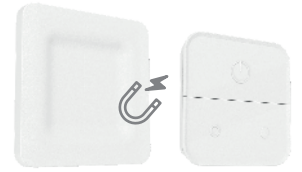

900116

The wall mount can be screwed or glued to smooth surfaces. The switch can be removed from its magnetic holder. The three buttons can be used to access various functions (on-off, dimming, CCT and RGB change).

Die Wandhalterung kann geschraubt oder an glatte Oberflächen geklebt werden. Der Schalter kann aus seiner magnetischen Halterung herausgenommen werden. Mit den drei Tasten können verschiedene Funktionen (Ein-Aus, Dimmen, CCT und RGB Wechsel) abgerufen werden.

Le support mural peut être vissé ou collé sur des surfaces lisses. L'interrupteur peut être retiré de son support magnétique. Les trois touches permettent d'accéder à différentes fonctions (marche/arrêt, variation, changement CCT et RGB).

99106



Mounting bracket incl.
Montagehalterung inkl.
Support de montage incl.

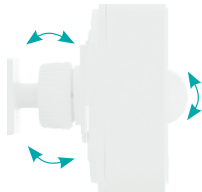

99106

120°, 12 m
20 sec. - 10 min.



IP44



900116

99099 CONNECT Z

remote control; plastic, grey
Fernbedienung; Kunststoff, grau
Télécommande; plastique, gris

L 122, B 54, H 18



AAA,
R03P



2 x 1,5V



9 002759 990992



99106 CONNECT-Z SENSOR

accessory; plastic, white
Zubehör; Kunststoff, weiss
Accessoires; plastique, blanc

L 75, H 75, A 70



AA,
LR6 HP



2900mAh,
1,5V



IP44



9 002759 991067



900116 CONNECT-Z SWITCH

accessory; plastic, white
Zubehör; Kunststoff, weiss
Accessoires; plastique, blanc

L 80, B 80, H 20



CR2032



9 008606 285761

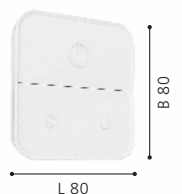



900764
LED



900766
LED



900764
LED

900766 CAROSSO-Z

recessed light; aluminium, white / plastic, white
Einbauleuchte; Alu, weiss / Kunststoff, weiss
luminaire encastrable; aluminium, blanc / plastique, blanc

H 28, Ø 93

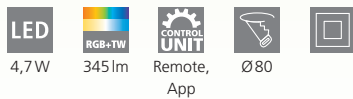

900764 CAROSSO-Z

recessed light; aluminium, black / plastic, white
Einbauleuchte; Alu, schwarz / Kunststoff, weiss
luminaire encastrable; aluminium, noir / plastique, blanc

H 28, Ø 93

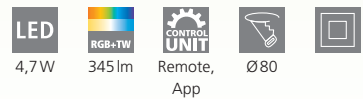



900765



900763



900765 CAROSSO-Z

recessed light; aluminium, white / plastic, white
 Einbauleuchte; Alu, weiss / Kunststoff, weiss
 luminaire encastrable; aluminium, blanc / plastique, blanc

L 93, B 93, H 25



900763 CAROSSO-Z

recessed light; aluminium, black / plastic, white
 Einbauleuchte; Alu, schwarz / Kunststoff, weiss
 luminaire encastrable; aluminium, noir / plastique, blanc

L 93, B 93, H 25

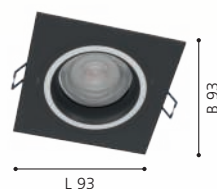
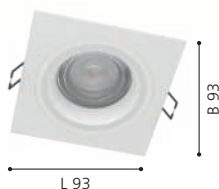
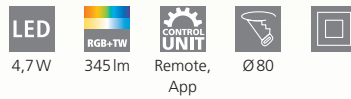



901169

LED



901168

LED

901169 CAROSSO-Z

surface-mounted light; aluminium, white / plastic, white
 Aufbauleuchte; Alu, weiss / Kunststoff, weiss
 luminaire en saillie; aluminium, blanc / plastique, blanc

H 95, Ø 80

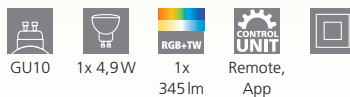

901168 CAROSSO-Z

surface-mounted light; aluminium, black / plastic, white
 Aufbauleuchte; Alu, schwarz / Kunststoff, weiss
 luminaire en saillie; aluminium, noir / plastique, blanc

H 95, Ø 80

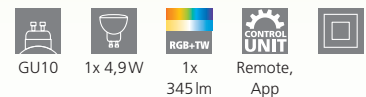



901168

LED





99671

LED





99669



99672



99671



99669 SALICETO-Z

recessed light; aluminium, black
 Einbauleuchte; Alu, schwarz
 luminaire encastrable; aluminium, noir

H 46, Ø 88, ET 50

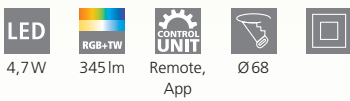

99671 SALICETO-Z

recessed light; aluminium, white
 Einbauleuchte; Alu, weiss
 luminaire encastrable; aluminium, blanc

H 46, Ø 88, ET 50

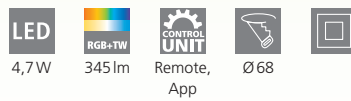

99672 SALICETO-Z

recessed light; aluminium, satin nickel
 Einbauleuchte; Alu, nickel-matt
 luminaire encastrable; aluminium, nickel mat

H 46, Ø 88, ET 50

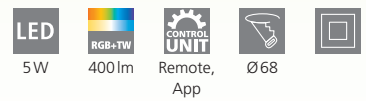



900481



900482



900483



900481 PADROGIANO-Z

ceiling light; steel, white / plastic, white
Deckenleuchte; Stahl, weiss / Kunststoff, weiss
plafonnier; acier, blanc / plastique, blanc

L 450, B 450, H 50

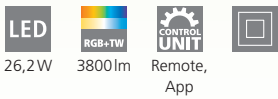

26,2W 3800lm Remote, App



9 008606 244164

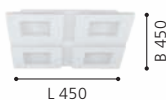

900482 PADROGIANO-Z

ceiling light; steel, white / plastic, white
Deckenleuchte; Stahl, weiss / Kunststoff, weiss
plafonnier; acier, blanc / plastique, blanc

L 1200, B 300, H 50



42,5W 6000lm Remote, App



9 008606 244171



900483 PADROGIANO-Z

ceiling light; steel, white / plastic, white
Deckenleuchte; Stahl, weiss / Kunststoff, weiss
plafonnier; acier, blanc / plastique, blanc

L 450, B 450, H 50



27,9W 3600lm Remote, App



9 008606 244188





900484

LED



PADROGIANO-Z

The frame of these luminaires can switch between the RGB colors, the inner part can reproduce different white tones between 2700K and 6500K. By controlling via app or remote control, individual lighting effects can be set.

Der Rahmen dieser Leuchten kann zwischen den RGB Farbtönen wechseln, der Innenteil kann verschiedene Weißtöne zwischen 2700K und 6500K wiedergeben. Durch Steuerung per App oder Fernbedienung können so individuelle Lichtspiele eingestellt werden.

Le cadre de cette luminaires peut basculer entre es couleurs RVB, la partie intérieure peut reproduire différents tons blancs entre 2700K et 6500K. En contrôlant via l'application ou la télécommande, des effets d'éclairage individuels peuvent être définis.



900485

LED

900484 PADROGIANO-Z

ceiling light; steel, white / plastic, white
Deckenleuchte; Stahl, weiss / Kunststoff, weiss
plafonnier; acier, blanc / plastique, blanc

L 595, B 595, H 50



900485 PADROGIANO-Z

ceiling light; steel, white / plastic, white
Deckenleuchte; Stahl, weiss / Kunststoff, weiss
plafonnier; acier, blanc / plastique, blanc

L 1200, B 300, H 50

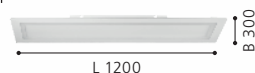



900486



PADROGIANO-Z

These lights have individually controllable light settings on the inside and outside of the frame.

Diese Leuchten verfügen über individuell steuerbare Lichteinstellungen der Rahmen innen und außen.

Ces lumières ont des paramètres d'éclairage contrôlables individuellement du cadre.



900487



900486 PADROGIANO-Z

ceiling light; steel, white / plastic, white
Deckenleuchte; Stahl, weiss / Kunststoff, weiss
plafonnier; acier, blanc / plastique, blanc

H 50, Ø 450



26,5W 3300lm Remote, App

900487 PADROGIANO-Z

ceiling light; steel, white / plastic, white
Deckenleuchte; Stahl, weiss / Kunststoff, weiss
plafonnier; acier, blanc / plastique, blanc

H 50, Ø 595



35W 4600lm Remote, App



9 008606 244218



9 008606 244225





900487

LED



900054

LED



900055

LED



900056

LED

900054 TURCONA-Z

ceiling light; steel, aluminium, white / plastic, white
Deckenleuchte; Stahl, Alu, weiss / Kunststoff, weiss
plafonnier; acier, aluminium, blanc / plastique, blanc

H 60, Ø 300

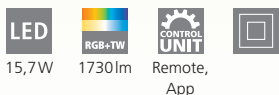

LED 15,7W RGB+TW 1730lm CONTROL UNIT Remote, App

900055 TURCONA-Z

ceiling light; steel, aluminium, white / plastic, white
Deckenleuchte; Stahl, Alu, weiss / Kunststoff, weiss
plafonnier; acier, aluminium, blanc / plastique, blanc

H 75, Ø 450



LED 22,4W RGB+TW 2490lm CONTROL UNIT Remote, App

900056 TURCONA-Z

ceiling light; steel, aluminium, white / plastic, white
Deckenleuchte; Stahl, Alu, weiss / Kunststoff, weiss
plafonnier; acier, aluminium, blanc / plastique, blanc

H 75, Ø 600



LED 34,2W RGB+TW 3980lm CONTROL UNIT Remote, App



9 008606 221905



Ø 300



9 008606 221912



Ø 450



9 008606 221929



Ø 600



900055

LED

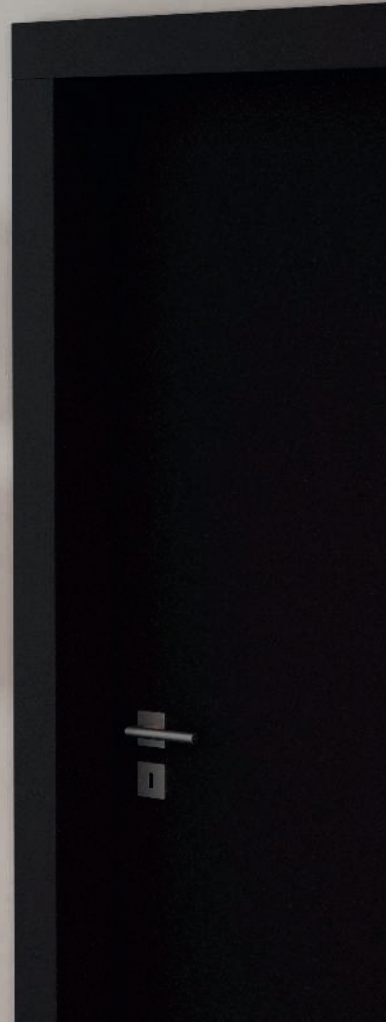



900758

LED



900759

LED

900758 SARSINA-Z

ceiling light; aluminium, steel, white / plastic, white
Deckenleuchte; Alu, Stahl, weiss / Kunststoff, weiss
plafonnier; aluminium, acier, blanc / plastique, blanc

H 52, Ø 450

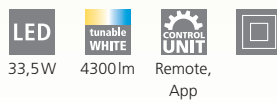

33,5W

4300lm

Remote,
App



9 008606 264049



900759 SARSINA-Z

ceiling light; aluminium, steel, white / plastic, white
Deckenleuchte; Alu, Stahl, weiss / Kunststoff, weiss
plafonnier; aluminium, acier, blanc / plastique, blanc

H 52, Ø 600

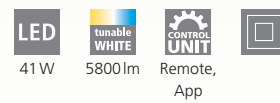

41 W

5800lm

Remote,
App



9 008606 264056





900761

LED



900762

LED

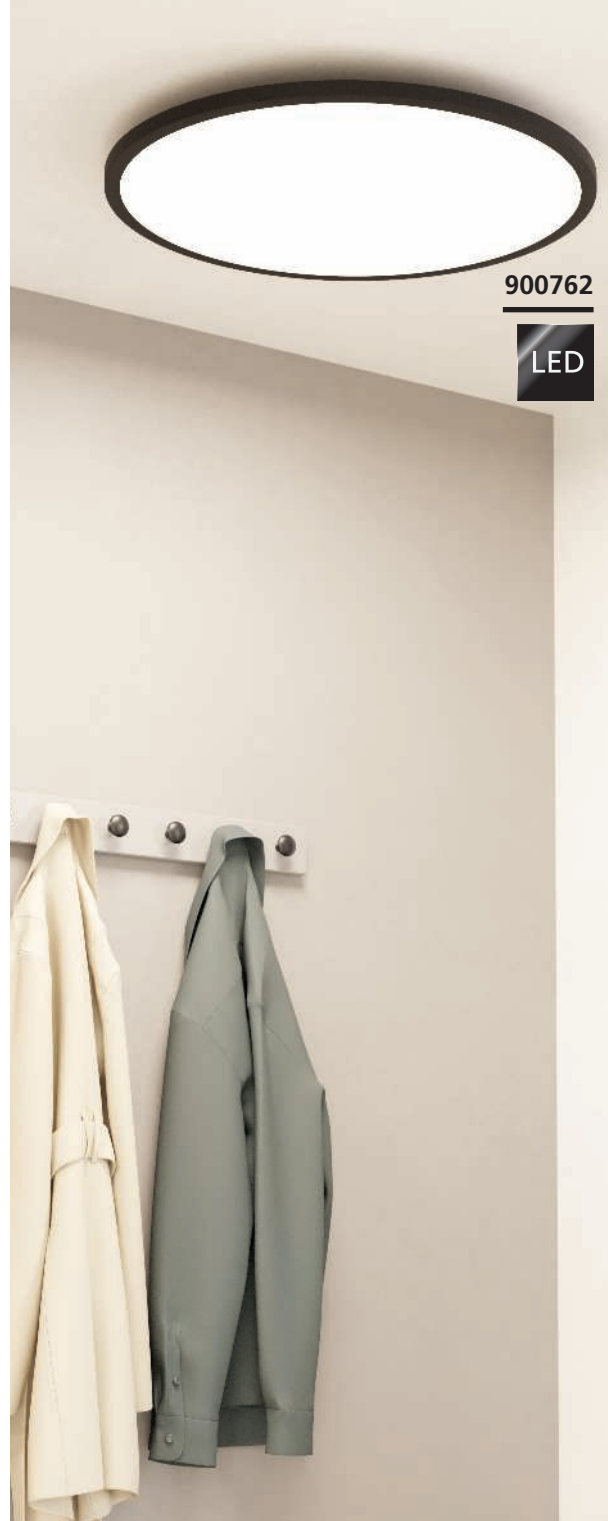

900762

LED

900761 SARSINA-Z

ceiling light; aluminium, steel, black / plastic, white
Deckenleuchte; Alu, Stahl, schwarz / Kunststoff, weiss
plafonnier; aluminium, acier, noir / plastique, blanc

H 52, Ø 450

LED

33,5 W

tunable
WHITE

4300 lm

CONTROL
UNIT

Remote,
App



9 008606 264063



900762 SARSINA-Z

ceiling light; aluminium, steel, black / plastic, white
Deckenleuchte; Alu, Stahl, schwarz / Kunststoff, weiss
plafonnier; aluminium, acier, noir / plastique, blanc

H 52, Ø 600

LED

41 W

tunable
WHITE

5800 lm

CONTROL
UNIT

Remote,
App



9 008606 264070





99639

LED



99548

LED



99549

LED

99639 HERRORA-Z

ceiling light; aluminium, white / plastic, white
Deckenleuchte; Alu, weiss / Kunststoff, weiss
plafonnier; aluminium, blanc / plastique, blanc

L 450, B 450, H 40



22W 2900lm Remote, App

99548 HERRORA-Z

ceiling light; aluminium, white / plastic, white
Deckenleuchte; Alu, weiss / Kunststoff, weiss
plafonnier; aluminium, blanc / plastique, blanc

L 595, B 595, H 40



6x 5,3W 4500lm Remote, App

99549 HERRORA-Z

ceiling light; aluminium, white / plastic, white
Deckenleuchte; Alu, weiss / Kunststoff, weiss
plafonnier; aluminium, blanc / plastique, blanc

L 1200, B 300, H 40



3x 10,5W 4500lm Remote, App



9 002759 996390

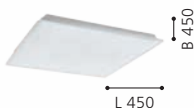

9 002759 995485

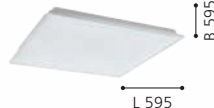

9 002759 995492





99639

LED





900057



900058



900059



TURCONA-Z

Frameless luminaires.

Rahmenlose Leuchten.

Luminaires sans cadre.

900057 TURCONA-Z

ceiling light; steel, aluminium, white / plastic, white
Deckenleuchte; Stahl, Alu, weiss / Kunststoff, weiss
plafonnier; acier, aluminium, blanc / plastique, blanc

L 300, B 300, H 50

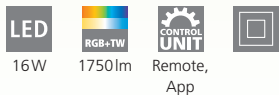

16W 1750lm Remote, App

900058 TURCONA-Z

ceiling light; steel, aluminium, white / plastic, white
Deckenleuchte; Stahl, Alu, weiss / Kunststoff, weiss
plafonnier; acier, aluminium, blanc / plastique, blanc

L 450, B 450, H 70



6x 3,8W 2400lm Remote, App

900059 TURCONA-Z

ceiling light; steel, aluminium, white / plastic, white
Deckenleuchte; Stahl, Alu, weiss / Kunststoff, weiss
plafonnier; acier, aluminium, blanc / plastique, blanc

L 600, B 600, H 75



6x 5,4W 4000lm Remote, App



9 008606 221936

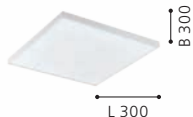

9 008606 221943

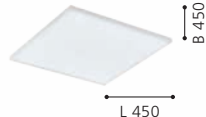

9 008606 221950

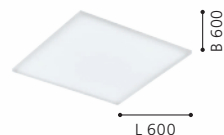



900062



900061



900062 TURCONA-Z

ceiling light; steel, aluminium, white / plastic, white
 Deckenleuchte; Stahl, Alu, weiss / Kunststoff, weiss
 plafonnier; acier, aluminium, blanc / plastique, blanc

L 1200, B 100, H 75

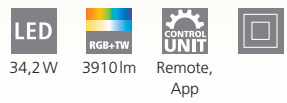

900061 TURCONA-Z

ceiling light; steel, aluminium, white / plastic, white
 Deckenleuchte; Stahl, Alu, weiss / Kunststoff, weiss
 plafonnier; acier, aluminium, blanc / plastique, blanc

L 1200, B 300, H 75

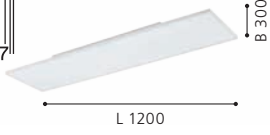
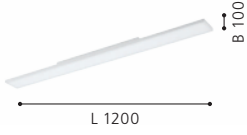
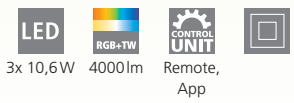



900044



900045



900046



900044 SALOBRENA-Z

ceiling light; aluminium, white / plastic, white
Deckenleuchte; Alu, weiss / Kunststoff, weiss
plafonnier; aluminium, blanc / plastique, blanc

L 300, B 300, H 50

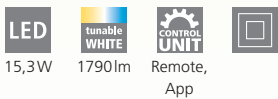

15,3W 1790lm Remote, App

900045 SALOBRENA-Z

ceiling light; aluminium, white / plastic, white
Deckenleuchte; Alu, weiss / Kunststoff, weiss
plafonnier; aluminium, blanc / plastique, blanc

L 450, B 450, H 50



21,5W 2500lm Remote, App

900046 SALOBRENA-Z

ceiling light; aluminium, white / plastic, white
Deckenleuchte; Alu, weiss / Kunststoff, weiss
plafonnier; aluminium, blanc / plastique, blanc

L 595, B 595, H 50

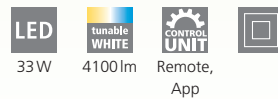

33W 4100lm Remote, App



9 008606 221813

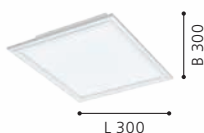

9 008606 221820

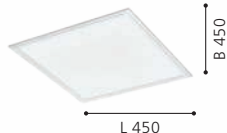

9 008606 221837

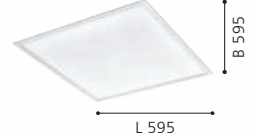



900047



900048



900047 SALOBRENA-Z

ceiling light; aluminium, white / plastic, white
Deckenleuchte; Alu, weiss / Kunststoff, weiss
plafonnier; aluminium, blanc / plastique, blanc

L 1200, B 300, H 50



900048 SALOBRENA-Z

ceiling light; aluminium, white / plastic, white
Deckenleuchte; Alu, weiss / Kunststoff, weiss
plafonnier; aluminium, blanc / plastique, blanc

L 1200, B 100, H 45

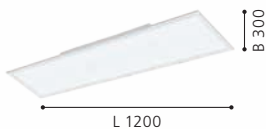
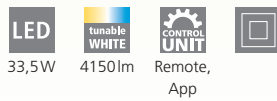

Zubehör inkludiert
Accessoires inclus



900049 SALOBRENA-Z

ceiling light; aluminium, black / plastic, white
Deckenleuchte; Alu, schwarz / Kunststoff, weiss
plafonnier; aluminium, noir / plastique, blanc

L 300, B 300, H 50

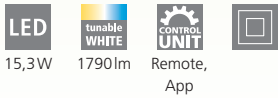

900051 SALOBRENA-Z

ceiling light; aluminium, black / plastic, white
Deckenleuchte; Alu, schwarz / Kunststoff, weiss
plafonnier; aluminium, noir / plastique, blanc

L 450, B 450, H 50



900052 SALOBRENA-Z

ceiling light; aluminium, black / plastic, white
Deckenleuchte; Alu, schwarz / Kunststoff, weiss
plafonnier; aluminium, noir / plastique, blanc

L 595, B 595, H 50

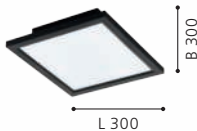
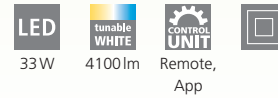



900053



900095



900053 SALOBRENA-Z

ceiling light; aluminium, black / plastic, white
 Deckenleuchte; Alu, schwarz / Kunststoff, weiss
 plafonnier; aluminium, noir / plastique, blanc

L 1200, B 300, H 50



900095 SALOBRENA-Z

ceiling light; aluminium, steel, black / plastic, white
 Deckenleuchte; Alu, Stahl, schwarz / Kunststoff, weiss
 plafonnier; aluminium, acier, noir / plastique, blanc

L 1200, B 100, H 45

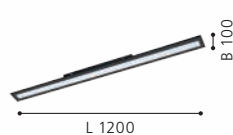
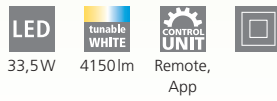

Zubehör inkludiert
 Accessoires inclus

900099, 900111, 900105

3 spots with one driver.

3 Spots mit einem Treiber.

3 spots avec une alimentation.

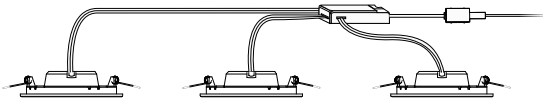

FUEVA-Z

H 26, Ø 85

recessed light
Einbauleuchte
luminaire encastrable

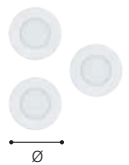

Material / Colour	Size	Cutout	Quantity	Watt	Lumen	IP class	Item no.	EAN code
steel, white / plastic, white Stahl, weiss / Kunststoff, weiss acier, blanc / plastique, blanc	H 26, Ø 85	Ø 75	3	3 x 2,8W	3x 390lm 	IP20/44	900099	9 008606 225569
steel, satin nickel / plastic, white Stahl, nickel-matt / Kunststoff, weiss acier, nickel mat / plastique, blanc	H 26, Ø 85	Ø 75	3	3 x 2,8W	3x 390lm 	IP20/44	900111	9 008606 225668
steel, black / plastic, white Stahl, schwarz / Kunststoff, weiss acier, noir / plastique, blanc	H 26, Ø 85	Ø 75	3	3 x 2,8W	3x 390lm 	IP20/44	900105	9 008606 225613



FUEVA-Z

H 26, Ø 120

recessed light
Einbauleuchte
luminaire encastrable



Material / Colour	Size	Cutout	Watt	Lumen	IP class	Item no.	EAN code
steel, white / plastic, white Stahl, weiss / Kunststoff, weiss acier, blanc / plastique, blanc	H 26, Ø 120	Ø 105	5,4W	700lm 	IP20/44	900101	9 008606 225576
steel, satin nickel / plastic, white Stahl, nickel-matt / Kunststoff, weiss acier, nickel mat / plastique, blanc	H 26, Ø 120	Ø 105	5,4W	700lm 	IP20/44	900112	9 008606 225675
steel, black / plastic, white Stahl, schwarz / Kunststoff, weiss acier, noir / plastique, blanc	H 26, Ø 120	Ø 105	5,4W	700lm 	IP20/44	900106	9 008606 225620



IP44



FUEVA-Z

Water-splash protected luminaires are labelled with an IP value.

Spritzwassergeschützte Leuchten sind mittels IP-Wert gekennzeichnet.

Les luminaires protégés contre les projections d'eau sont identifiés au moyen de la valeur IP.

	0	1	2	3
EU	X	X	✓	✓
FR	X	X	X	✓



DIMMABLE
VIA REMOTE
AND APP

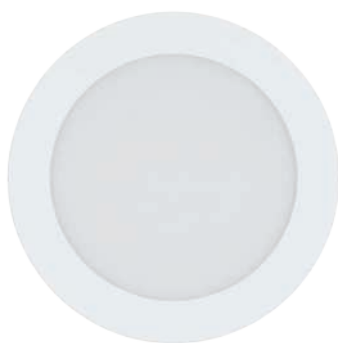









FUEVA-Z

H 26, Ø 165

recessed light
Einbauleuchte
luminaire encastrable



Material / Colour	Size	Cutout	Watt	Lumen	IP class	Item no.	EAN code
 steel, white / plastic, white Stahl, weiss / Kunststoff, weiss acier, blanc / plastique, blanc	H 26, Ø 165	Ø 155	10,5W	 1520lm  Remote, App	IP20/44	900102	9 008606 225583
 steel, satin nickel / plastic, white Stahl, nickel-matt / Kunststoff, weiss acier, nickel mat / plastique, blanc	H 26, Ø 165	Ø 155	10,5W	 1520lm  Remote, App	IP20/44	900113	9 008606 225682
 steel, black / plastic, white Stahl, schwarz / Kunststoff, weiss acier, noir / plastique, blanc	H 26, Ø 165	Ø 155	10,5W	 1520lm  Remote, App	IP20/44	900107	9 008606 225637











FUEVA-Z

Ø 216, ET 26

recessed light
Einbauleuchte
luminaire encastrable



Material / Colour	Size	Cutout	Watt	Lumen	IP class	Item no.	EAN code
 aluminium, white / plastic, white Alu, weiss / Kunststoff, weiss aluminium, blanc / plastique, blanc	Ø 216, ET 26	Ø 205	16,5W	 2100lm  Remote, App	IP20/44	98842	9 002759 988425
 aluminium, satin nickel / plastic, white Alu, nickel-matt / Kunststoff, weiss aluminium, nickel mat / plastique, blanc	Ø 216, ET 26	Ø 205	16,5W	 2100lm  Remote, App	IP20/44	98844	9 002759 988449
 aluminium, black / plastic, white Alu, schwarz / Kunststoff, weiss aluminium, noir / plastique, blanc	Ø 216, ET 26	Ø 205	16,5W	 2100lm  Remote, App	IP20/44	98846	9 002759 988463

DIMMABLE
VIA REMOTE
AND APP









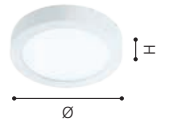

FUEVA-Z

H 28, Ø 210

surface-mounted light
Aufbauleuchte
luminaire en saillie



Material / Colour	Size	Watt	Lumen	IP class	Item no.	EAN code
 steel, white / plastic, white Stahl, weiss / Kunststoff, weiss acier, blanc / plastique, blanc	H 28, Ø 210	16,5 W	 2250lm	 Remote, App IP44	900103	9 008606 225590
 steel, satin nickel / plastic, white Stahl, nickel-matt / Kunststoff, weiss acier, nickel mat / plastique, blanc	H 28, Ø 210	16,5 W	 2250lm	 Remote, App IP44	900114	9 008606 225699
 steel, black / plastic, white Stahl, schwarz / Kunststoff, weiss acier, noir / plastique, blanc	H 28, Ø 210	16,5 W	 2250lm	 Remote, App IP44	900108	9 008606 225644









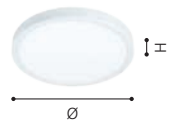

FUEVA-Z

H 28, Ø 285

surface-mounted light
Aufbauleuchte
luminaire en saillie



Material / Colour	Size	Watt	Lumen	IP class	Item no.	EAN code
 aluminium, white / plastic, white Alu, weiss / Kunststoff, weiss aluminium, blanc / plastique, blanc	H 28, Ø 285	19,5 W	 2500lm	 Remote, App IP44	98843	9 002759 988432
 aluminium, satin nickel / plastic, white Alu, nickel-matt / Kunststoff, weiss aluminium, nickel mat / plastique, blanc	H 28, Ø 285	19,5 W	 2500lm	 Remote, App IP44	98845	9 002759 988456
 aluminium, black / plastic, white Alu, schwarz / Kunststoff, weiss aluminium, noir / plastique, blanc	H 28, Ø 285	19,5 W	 2500lm	 Remote, App IP44	98847	9 002759 988470





DIMMABLE
VIA REMOTE
AND APP



FUEVA-Z

L 210, B 210, H 28

surface-mounted light
Aufbauleuchte
luminaire en saillie

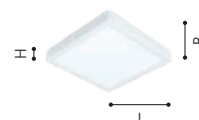

Material / Colour	Size	Watt	Lumen	IP class	Item no.	EAN code
steel, white / plastic, white Stahl, weiss / Kunststoff, weiss acier, blanc / plastique, blanc	L 210, B 210, H 28	16,5W	2250lm	Remote, App IP44	900104	9 008606 225606
steel, satin nickel / plastic, white Stahl, nickel-matt / Kunststoff, weiss acier, nickel mat / plastique, blanc	L 210, B 210, H 28	16,5W	2250lm	Remote, App IP44	900115	9 008606 225705
steel, black / plastic, white Stahl, schwarz / Kunststoff, weiss acier, noir / plastique, blanc	L 210, B 210, H 28	16,5W	2250lm	Remote, App IP44	900109	9 008606 225651

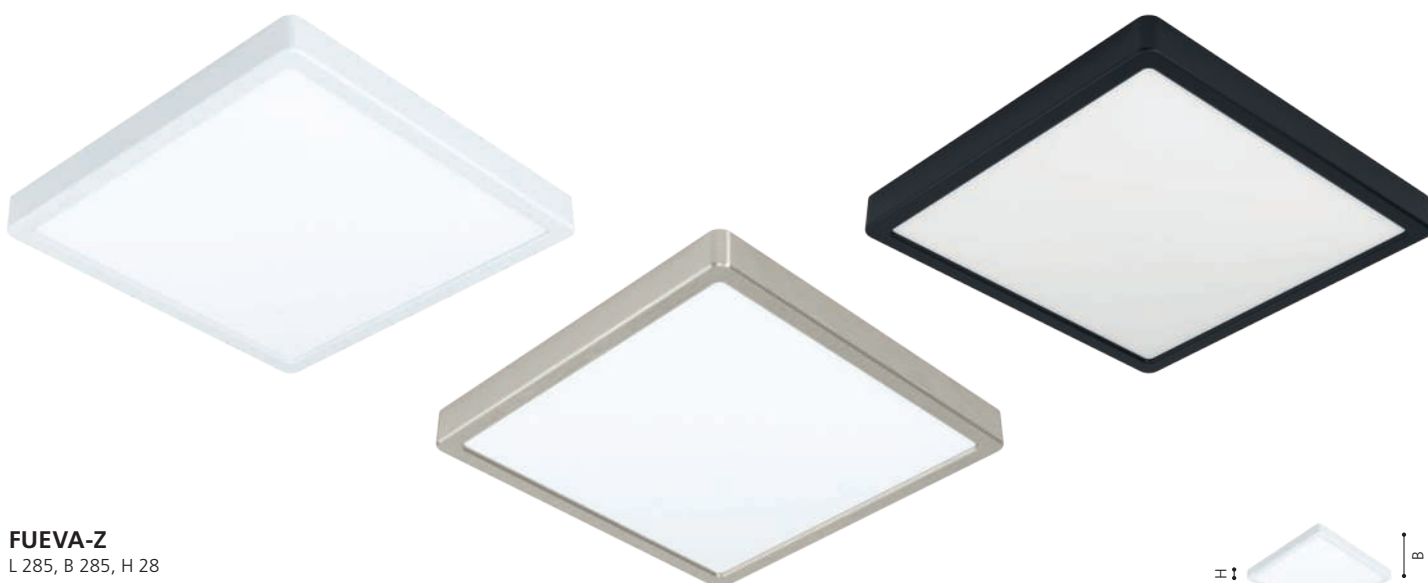

FUEVA-Z

L 285, B 285, H 28

surface-mounted light
Aufbauleuchte
luminaire en saillie

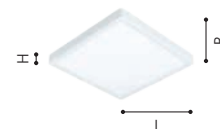

Material / Colour	Size	Watt	Lumen	IP class	Item no.	EAN code
aluminium, white / plastic, white Alu, weiss / Kunststoff, weiss aluminium, blanc / plastique, blanc	L 285, B 285, H 28	19,5W	2500lm	Remote, App IP44	98849	9 002759 988494
aluminium, satin nickel / plastic, white Alu, nickel-matt / Kunststoff, weiss aluminium, nickel mat / plastique, blanc	L 285, B 285, H 28	19,5W	2500lm	Remote, App IP44	98852	9 002759 988524
aluminium, black / plastic, white Alu, schwarz / Kunststoff, weiss aluminium, noir / plastique, blanc	L 285, B 285, H 28	19,5W	2500lm	Remote, App IP44	98854	9 002759 988548



901463



IP44



901464



IP44



901465



IP44

901463 ROVITO-Z

ceiling light; plastic, black / plastic, white
Deckenleuchte; Kunststoff, schwarz / Kunststoff, weiss
plafonnier; plastique, noir / plastique, blanc

H 30, Ø 300

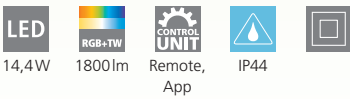

14,4W 1800lm Remote, App

901464 ROVITO-Z

ceiling light; plastic, black / plastic, white
Deckenleuchte; Kunststoff, schwarz / Kunststoff, weiss
plafonnier; plastique, noir / plastique, blanc

H 30, Ø 390

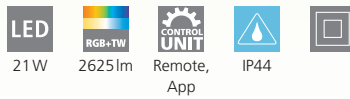

21W 2625lm Remote, App

901465 ROVITO-Z

ceiling light; plastic, black / plastic, white
Deckenleuchte; Kunststoff, schwarz / Kunststoff, weiss
plafonnier; plastique, noir / plastique, blanc

H 32, Ø 500

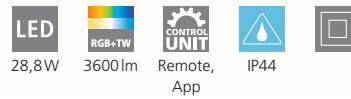

28,8W 3600lm Remote, App



9 008606 329700

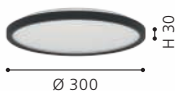

9 008606 329717



9 008606 329724





901466



IP44

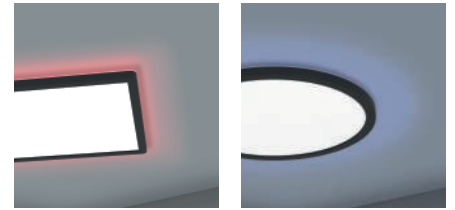

ROVITO-Z

These lights have individually controllable light settings on the inside and outside of the frame.

Diese Leuchten verfügen über individuell steuerbare Lichteinstellungen der Rahmen innen und außen.

Ces lumières ont des paramètres d'éclairage contrôlables individuellement du cadre.

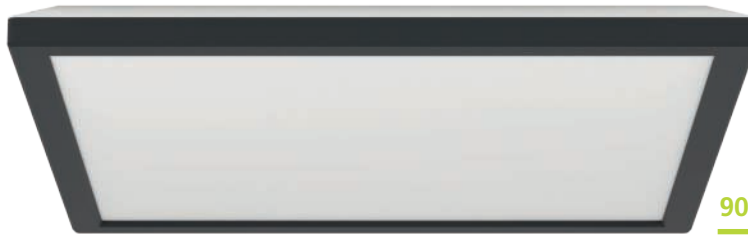

901467



IP44

901466 ROVITO-Z

ceiling light; plastic, black / plastic, white
Deckenleuchte; Kunststoff, schwarz / Kunststoff, weiss
plafonnier; plastique, noir / plastique, blanc

L 290, B 290, H 30



14,4 W



2000 lm



Remote,
App



IP44



901467 ROVITO-Z

ceiling light; plastic, black / plastic, white
Deckenleuchte; Kunststoff, schwarz / Kunststoff, weiss
plafonnier; plastique, noir / plastique, blanc

L 390, B 390, H 30



21 W



3000 lm



Remote,
App



IP44



9 008606 329731



L 290

B 290



9 008606 329748

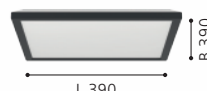

L 390

B 390

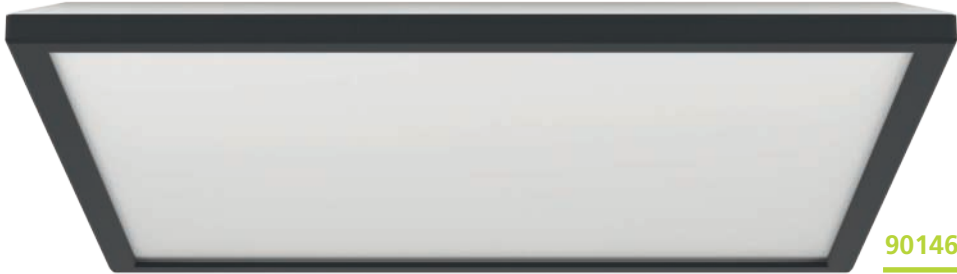

901468



IP44



901469



IP44

901468 ROVITO-Z

ceiling light; plastic, black / plastic, white
 Deckenleuchte; Kunststoff, schwarz / Kunststoff, weiss
 plafonnier; plastique, noir / plastique, blanc

L 500, B 500, H 32



28,8W 4200lm Remote, App

901469 ROVITO-Z

ceiling light; plastic, black / plastic, white
 Deckenleuchte; Kunststoff, schwarz / Kunststoff, weiss
 plafonnier; plastique, noir / plastique, blanc

L 570, B 300, H 30



21W 3000lm Remote, App



9 008606 329755

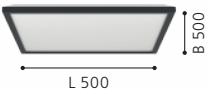

9 008606 329762





ROVITO-Z

These lights have individually controllable light settings on the inside and outside of the frame.

Diese Leuchten verfügen über individuell steuerbare Lichteinstellungen der Rahmen innen und außen.

Ces lumières ont des paramètres d'éclairage contrôlables individuellement du cadre.

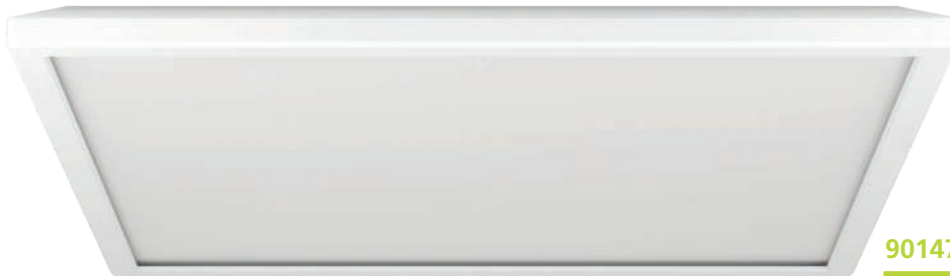

901476



IP44



901477



IP44

901476 ROVITO-Z

ceiling light; plastic, white / plastic, white
Deckenleuchte; Kunststoff, weiss / Kunststoff, weiss
plafonnier; plastique, blanc / plastique, blanc

L 500, B 500, H 32



28,8 W



4200 lm



Remote,
App



IP44



901477 ROVITO-Z

ceiling light; plastic, white / plastic, white
Deckenleuchte; Kunststoff, weiss / Kunststoff, weiss
plafonnier; plastique, blanc / plastique, blanc

L 570, B 300, H 30



21 W



3000 lm



Remote,
App



IP44



9 008606 329830

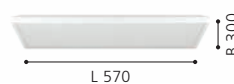



901471



IP44



901472



IP44



901473



IP44

901471 ROVITO-Z

ceiling light; plastic, white / plastic, white
Deckenleuchte; Kunststoff, weiss / Kunststoff, weiss
plafonnier; plastique, blanc / plastique, blanc

H 30, Ø 300

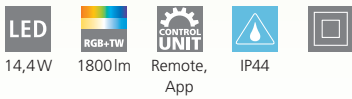

14,4W 1800lm Remote, App



9 008606 329779



901472 ROVITO-Z

ceiling light; plastic, white / plastic, white
Deckenleuchte; Kunststoff, weiss / Kunststoff, weiss
plafonnier; plastique, blanc / plastique, blanc

H 30, Ø 390

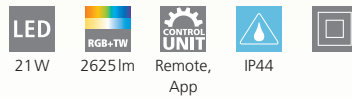

21W 2625lm Remote, App



9 008606 329786



901473 ROVITO-Z

ceiling light; plastic, white / plastic, white
Deckenleuchte; Kunststoff, weiss / Kunststoff, weiss
plafonnier; plastique, blanc / plastique, blanc

H 32, Ø 500

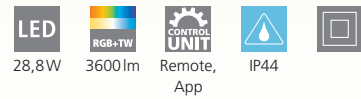

28,8W 3600lm Remote, App



9 008606 329793





901474



IP44

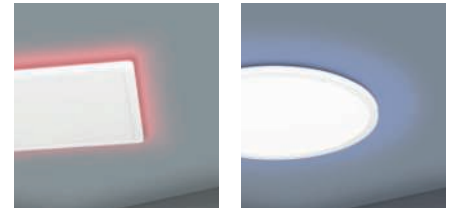

ROVITO-Z

These lights have individually controllable light settings on the inside and outside of the frame.

Diese Leuchten verfügen über individuell steuerbare Lichteinstellungen der Rahmen innen und außen.

Ces lumières ont des paramètres d'éclairage contrôlables individuellement du cadre.

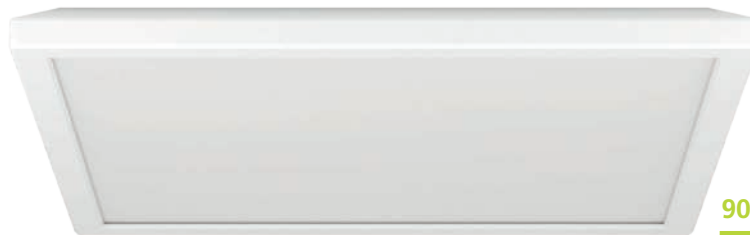

901475



IP44

901474 ROVITO-Z

ceiling light; plastic, white / plastic, white
Deckenleuchte; Kunststoff, weiss / Kunststoff, weiss
plafonnier; plastique, blanc / plastique, blanc

L 290, B 290, H 30



14,4 W



2000 lm



Remote,
App



IP44



901475 ROVITO-Z

ceiling light; plastic, white / plastic, white
Deckenleuchte; Kunststoff, weiss / Kunststoff, weiss
plafonnier; plastique, blanc / plastique, blanc

L 390, B 390, H 30



21 W



3000 lm



Remote,
App



IP44



9 008606 329809



L 290

B 290



9 008606 329816



L 290

B 290



901108



NEON-STRIPE-Z

Fixing clips are included in the scope of delivery.

Befestigungsclips im Lieferumfang enthalten.

Les clips de fixation sont inclus dans la livraison.



901109



901108 NEON-STRIPE-Z

bar/strip light; plastic, white
 Leuchtband/-stab; Kunststoff, weiss
 bande lumineuse / bâton l; plastique, blanc

L 3000, B 18, H 8



901109 NEON-STRIPE-Z

bar/strip light; plastic, white
 Leuchtband/-stab; Kunststoff, weiss
 bande lumineuse / bâton l; plastique, blanc

L 5000, B 18, H 8



9 008606 295265



L 3000



9 008606 295272



L 5000



901109

LED



99684, 99685

These LED strips are very flexible and are perfect for shaping.

Diese LED-Streifen sind sehr flexibel und eignen sich perfekt zum Formen.

Ces bandes LED sont très flexibles et conviennent parfaitement à la mise en forme.



99684

Driver included.
Treiber inkludiert.
Chauffeur inclus.

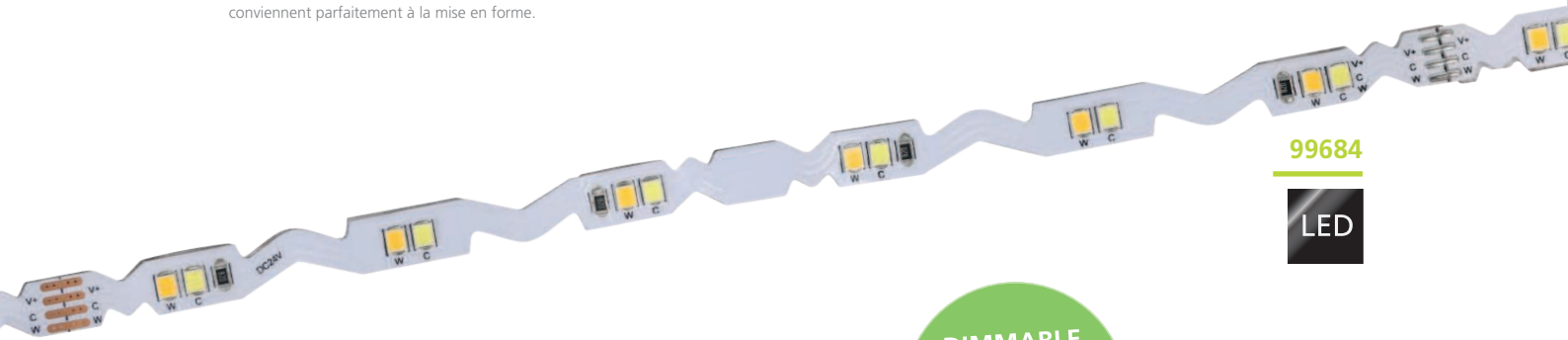
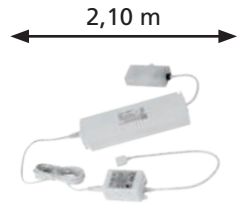

99684



99685

Extension for starter set 99684 without driver.

Erweiterung für Starterset 99684 ohne Treiber.

Rallonge pour kit de démarrage 99684 sans pilote.



99685



99684 LED STRIPE-Z

bar/strip light; plastic, white
Leuchtband/-stab; Kunststoff, weiss
bande lumineuse / bâton l; plastique, blanc

L 3000, B 8



13,5W 1450lm Remote, App



9 002759 996840



L 3000

99685 LED STRIPE-Z

bar/strip light; plastic, white
Leuchtband/-stab; Kunststoff, weiss
bande lumineuse / bâton l; plastique, blanc

L 2000, B 8



9W 950lm Remote, App



9 002759 996857



L 2000

1,50 m



99686

Driver included.
Treiber inkludiert.
Chauffeur inclus.

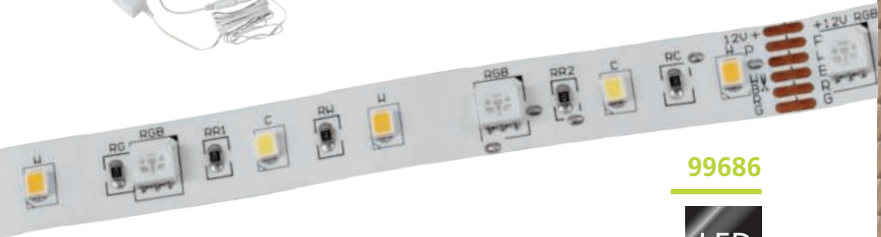

99686



3,40 m



99687

Driver included.
Treiber inkludiert.
Chauffeur inclus.



99687



99687



99686 LED STRIPE-Z

bar/strip light; plastic, white
Leuchtband/-stab; Kunststoff, weiss
bande lumineuse / bâton I; plastique, blanc

L 5000, B 12

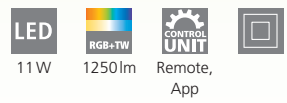

11 W

1250lm

Remote,
App



9 002759 996864



L 5000

99687 LED STRIPE-Z

bar/strip light; plastic, white
Leuchtband/-stab; Kunststoff, weiss
bande lumineuse / bâton I; plastique, blanc

L 8000, B 12

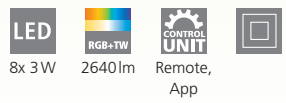

8x 3 W

2640lm

Remote,
App



9 002759 996871



L 8000





EGLO EXPERT

ADVANTAGES

- > HIGH-QUALITY MOISTURE-PROOF, WALL, CEILING AND UNDER-CABINET LUMINAIRES FOR KITCHENS, GARAGES AND WAREHOUSES
 - > THE RANGE IS INNOVATIVE AND PERFECTED DOWN TO THE LAST DETAIL
 - > LARGE SELECTION OF LED TUBE BULBS
 - > PREMIUM MODELS IN EEI CLASS C OFFER HIGH PERFORMANCE WITH LOW ENERGY CONSUMPTION
-

VORTEILE

- > HOCHWERTIGE FEUCHTRAUM-, WAND-, DECKEN- UND UNTERBAULEUCHTEN FÜR KÜCHEN, GARAGEN UND LAGERHALLEN
 - > INNOVATIVES UND PERFEKTIONIERTES SORTIMENT BIS INS DETAIL
 - > GROSSE AUSWAHL AN LED TUBE LEUCHTMITTELN
 - > PREMIUMMODELLE IN EEI KLASSE C BIETEN HOHE LEISTUNG BEI NIEDRIGEM ENERGIEVERBRAUCH
-

AVANTAGES

- > DES LUMINAIRES DE HAUTE QUALITÉ POUR LOCAUX HUMIDES, DES APPLIQUES MURALES, DES PLAFONNIERS ET DES LUMINAIRES ENCASTRÉS POUR LES CUISINES, LES GARAGES ET LES ENTREPÔTS.
- > L'ASSORTIMENT EST INNOVANT ET PERFECTIONNÉ JUSQUE DANS LES MOINDRES DÉTAILS
- > GRAND CHOIX D'AMPOULES À TUBE LED
- > LES MODÈLES HAUT DE GAMME DE CLASSE EEI C OFFRENT DES PERFORMANCES ÉLEVÉES POUR UNE FAIBLE CONSOMMATION D'ÉNERGIE





EGLO EXPERT

TRI-PROOF

ADVANTAGES

- > **NEWLY DEVELOPED DAMP-PROOF LUMINAIRES** - for use in damp or wet environments such as bathrooms, kitchens, garages, cellars or outdoor areas
- > **WATERPROOF AND MOISTURE-RESISTANT** - special seals and gaskets protect against moisture and water, making them ideal for environments where conventional luminaires could be damaged, all damp-proof luminaires are certified to at least IP65 class, the Ammonia series to IP69K class
- > **DURABILITY** - robust and resistant materials guarantee safety against moisture, shocks and vibrations, long service life even under demanding conditions
- > **VERSATILITY** - available in different sizes, shapes and light intensities, can be used both indoors and outdoors, suitable for different applications and environments
- > **ENERGY EFFICIENCY** - most of our models are EEI class C, consuming less energy and reducing operating costs with high lumen output
- > **EASY INSTALLATION AND MAINTENANCE** - simple installation with minimal maintenance, quick and easy maintenance and cleaning
- > **CIRCUIT BOARDS AND REPLACEABLE LIGHT SOURCES** - Basic series is supplied with replaceable LED tubes, all other series have an integrated LED circuit board

VORTEILE

- > **NEU ENTWICKELTE FEUCHTRAUMLEUCHTEN** - Einsatz in feuchten oder nassen Umgebungen wie Badezimmern, Küchen, Garagen, Kellern oder Außenbereichen
- > **WASSERDICHT UND FEUCHTIGKEITSBESTÄNDIG** - spezielle Dichtungen und Abdichtungen schützen vor Feuchtigkeit und Wasser, dadurch ideal für Umgebungen, in denen herkömmliche Leuchten beschädigt werden können, alle Feuchtraumleuchten sind min. in IP65-Klasse, die Ammoniak Serie in IP69K-Klasse zertifiziert
- > **LANGLEBIGKEIT** - robuste und widerstandsfähige Materialien garantieren sowohl Sicherheit gegenüber Feuchtigkeit, Stößen und Vibrationen, als auch eine lange Lebensdauer unter anspruchsvollen Bedingungen
- > **VIELSEITIGKEIT** - in verschiedenen Größen, Formen und Lichtstärken erhältlich, können sowohl im Innen- als auch im Außenbereich eingesetzt werden, eignen sich für verschiedene Anwendungen und Umgebungen
- > **ENERGIEEFFIZIENZ** - unsere Modelle sind zum größten Teil in EEI-Klasse C erhältlich, verbrauchen weniger Energie und senken die Betriebskosten bei hohem Lumenoutput
- > **EINFACHE INSTALLATION UND WARTUNG** - einfache Installation, schnelle und unkomplizierte Wartung und Reinigung
- > **PLATINEN UND WECHSELBARE LEUCHTMITTEL** - Basic Serie wird inklusive wechselbarer LED Tubes geliefert, alle anderen Serien haben eine integrierte LED Platine verbaut

AVANTAGES

- > **LUMINAIRES POUR LOCAUX HUMIDES NOUVELLEMENT DÉVELOPPÉS** - utilisation dans des environnements humides ou mouillés comme les salles de bains, les cuisines, les garages, les caves ou les espaces extérieurs
- > **ÉTANCHÉITÉ ET RÉSISTANCE À L'HUMIDITÉ** - des joints et des garnitures spéciaux protègent contre l'humidité et l'eau, ce qui est idéal pour les environnements où les luminaires traditionnels pourraient être endommagés, tous les luminaires pour locaux humides sont certifiés au minimum en classe IP65, la série Ammoniak en classe IP69K
- > **DURABILITÉ** - des matériaux robustes et résistants garantissent la sécurité contre l'humidité, les chocs et les vibrations, longue durée de vie même dans des conditions exigeantes
- > **POLYVALENCE** - disponibles en différentes tailles, formes et intensités lumineuses, peuvent être utilisés à l'intérieur comme à l'extérieur, conviennent à différentes applications et environnements
- > **EFFICACITÉ ÉNERGÉTIQUE** - nos modèles sont pour la plupart de classe EEI C, consomment moins d'énergie et réduisent les coûts d'exploitation tout en produisant beaucoup de lumens
- > **FACILITÉ D'INSTALLATION ET D'ENTRETIEN** - installation simple avec un minimum d'entretien, entretien et nettoyage rapides et faciles
- > **PLATINES ET LAMPES INTERCHANGEABLES** - la série Basic est livrée avec des tubes LED interchangeables, toutes les autres séries sont équipées d'une platine LED intégrée

OVERVIEW



This product is available in different colors and shapes./ Dieser Artikel ist in unterschiedlichen Farben und Formen verfügbar./
Cet article est disponible en différentes couleurs et formes.



901541



901542



901543



901541 BASIC

tri proof lamp; plastic, grey / plastic, transparent
Feuchtraumleuchte; Kunststoff, grau / Kunststoff, transparent
Réglette étanche; plastique, gris / plastique, transparent

L 1260, B 73, H 56



901542 BASIC

tri proof lamp; plastic, grey / plastic, transparent
Feuchtraumleuchte; Kunststoff, grau / Kunststoff, transparent
Réglette étanche; plastique, gris / plastique, transparent

L 1260, B 99, H 56



901543 BASIC

tri proof lamp; plastic, grey / plastic, transparent
Feuchtraumleuchte; Kunststoff, grau / Kunststoff, transparent
Réglette étanche; plastique, gris / plastique, transparent

L 1560, B 73, H 56

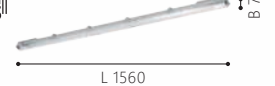
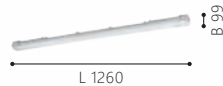
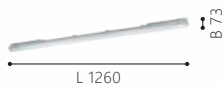



901544

LED



901544 BASIC

tri proof lamp; plastic, grey / plastic, transparent
 Feuchtraumleuchte; Kunststoff, grau / Kunststoff, transparent
 Réglette étanche; plastique, gris / plastique, transparent

L 1560, B 99, H 56



G13



2x 23 W



neutral
 WHITE
 2x
 2600lm



IP65

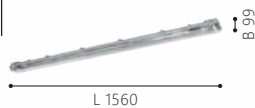



901545



901546



MECHANICAL PROTECTION
STOSSFESTIGKEIT
RÉSISTANCE AUX CHOCS

IK06



901547



901545 BASIC PLUS

tri proof lamp; plastic, grey / plastic, transparent
Feuchtraumleuchte; Kunststoff, grau / Kunststoff, transparent
Réglette étanche; plastique, gris / plastique, transparent

L 650, B 73, H 56



901546 BASIC PLUS

tri proof lamp; plastic, grey / plastic, transparent
Feuchtraumleuchte; Kunststoff, grau / Kunststoff, transparent
Réglette étanche; plastique, gris / plastique, transparent

L 1260, B 73, H 56

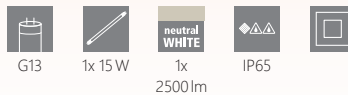

901547 BASIC PLUS

tri proof lamp; plastic, grey / plastic, transparent
Feuchtraumleuchte; Kunststoff, grau / Kunststoff, transparent
Réglette étanche; plastique, gris / plastique, transparent

L 1260, B 99, H 56

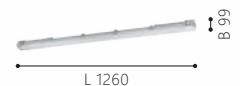
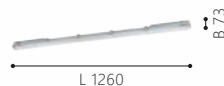
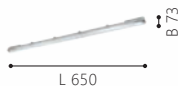
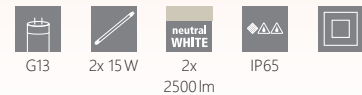



BASIC PLUS

- > INOX Clips
- > Metal reflector
- > High lumen tubes EEI C

- > INOX-Clips
- > Metallreflektor
- > Hochlumenröhren EEI C

- > INOX Clips
- > Réflecteur métallique
- > Tubes à haute luminosité EEI C



901548



901549



901548 BASIC PLUS

tri proof lamp; plastic, grey / plastic, transparent
 Feuchtraumleuchte; Kunststoff, grau / Kunststoff, transparent
 Réglette étanche; plastique, gris / plastique, transparent

L 1560, B 73, H 56



901549 BASIC PLUS

tri proof lamp; plastic, grey / plastic, transparent
 Feuchtraumleuchte; Kunststoff, grau / Kunststoff, transparent
 Réglette étanche; plastique, gris / plastique, transparent

L 1560, B 99, H 56



9 008606 313358

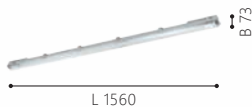

9 008606 313365







901551 SLIM

tri proof lamp; plastic, white / plastic, white
 Feuchtraumleuchte; Kunststoff, weiss / Kunststoff, weiss
 Réglette étanche; plastique, blanc / plastique, blanc

L 595, B 56, H 53



901552 SLIM

tri proof lamp; plastic, white / plastic, white
 Feuchtraumleuchte; Kunststoff, weiss / Kunststoff, weiss
 Réglette étanche; plastique, blanc / plastique, blanc

L 1105, B 56, H 53



901553 SLIM

tri proof lamp; plastic, white / plastic, white
 Feuchtraumleuchte; Kunststoff, weiss / Kunststoff, weiss
 Réglette étanche; plastique, blanc / plastique, blanc

L 1495, B 56, H 53

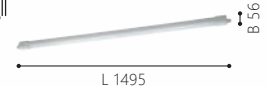
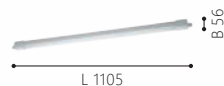



901554



901555



901554 SLIM CCT

tri proof lamp; plastic, white / plastic, white
 Feuchtraumleuchte; Kunststoff, weiss / Kunststoff, weiss
 Réglette étanche; plastique, blanc / plastique, blanc

L 1105, B 56, H 53



32W



5600lm



IP65



9 008606 313402

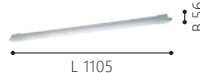

901555 SLIM CCT

tri proof lamp; plastic, white / plastic, white
 Feuchtraumleuchte; Kunststoff, weiss / Kunststoff, weiss
 Réglette étanche; plastique, blanc / plastique, blanc

L 1495, B 56, H 53



48W



7700lm



IP65



9 008606 313419





901556



IP65



901557



IP65

901556 SLIM SENSOR

tri proof lamp; plastic, white / plastic, white
Feuchtraumleuchte; Kunststoff, weiss / Kunststoff, weiss
Réglette étanche; plastique, blanc / plastique, blanc

L 1105, B 56, H 53



32 W



5600 lm



IP65



9 008606 313426



L 1105

B 56

901557 SLIM SENSOR

tri proof lamp; plastic, white / plastic, white
Feuchtraumleuchte; Kunststoff, weiss / Kunststoff, weiss
Réglette étanche; plastique, blanc / plastique, blanc

L 1495, B 56, H 53



48 W



8500 lm



IP65



9 008606 313433



L 1495

B 56



901558



EASY FIX

- > tool free installation
- > 3 pole connector
- > mounting in series
- > IK10 - ultra robust

- > werkzeuglose Montage
- > 3-poliger Steckverbinder
- > Montage in Reihe
- > IK10 - extrem robust

- > Installation sans outil
- > Connecteur 3 pôles
- > Montage en série
- > IK10 - ultra robuste



901559



901561



901558 EASY FIX

tri proof lamp; plastic, grey / plastic, white
 Feuchtraumleuchte; Kunststoff, grau / Kunststoff, weiss
 Réglette étanche; plastique, gris / plastique, blanc

L 600, B 67, H 72



901559 EASY FIX

tri proof lamp; plastic, grey / plastic, white
 Feuchtraumleuchte; Kunststoff, grau / Kunststoff, weiss
 Réglette étanche; plastique, gris / plastique, blanc

L 1090, B 67, H 72



901561 EASY FIX

tri proof lamp; plastic, grey / plastic, white
 Feuchtraumleuchte; Kunststoff, grau / Kunststoff, weiss
 Réglette étanche; plastique, gris / plastique, blanc

L 1490, B 67, H 72



9 008606 313440



9 008606 313457



9 008606 313464





PRIME

- > tool free installation
- > wired through 5 pole in line and series mountable
- > additional central feeder
- > werkzeuglose Montage
- > 5-polig verdrahtet in Reihe und Serie montierbar
- > zusätzliche Zentraleinspeisung
- > installation sans outil
- > câblage par 5 pôles en ligne et montage en série
- > alimentation centrale supplémentaire



901562



IP65



901563



IP65



901562 PRIME

tri proof lamp; plastic, grey / plastic, white
 Feuchtraumleuchte; Kunststoff, grau / Kunststoff, weiss
 Réglette étanche; plastique, gris / plastique, blanc

L 1190, B 85, H 80



27W



4400lm



IP65

901563 PRIME

tri proof lamp; plastic, grey / plastic, white
 Feuchtraumleuchte; Kunststoff, grau / Kunststoff, weiss
 Réglette étanche; plastique, gris / plastique, blanc

L 1490, B 85, H 80



42W



6750lm



IP65



9 008606 313471



L 1190



9 008606 313488



L 1490



901564



901565



901537

AMMONIAK

- › ammoniak resistant materials
- › suitable for high pressure water jets and hot water
- › ideal for animal farming and car washes
- › wired through 5 pole in line and series mountable
- › ammoniakresistente Materialien
- › geeignet für Hochdruck- und Heißwasserstrahlen
- › ideal für Tierhaltung und Autowäsche
- › 5-polig verdrahtet in Reihe und Serie montierbar
- › matériaux résistants à l'ammoniac
- › convient aux jets d'eau à haute pression et à l'eau chaude
- › idéal pour l'élevage et le lavage de voitures
- › câblage par 5 pôles en ligne et montage en série

901564 AMMONIAK

tri proof lamp; plastic, grey / plastic, white
 Feuchtraumleuchte; Kunststoff, grau / Kunststoff, weiss
 Réglette étanche; plastique, gris / plastique, blanc

L 1190, B 85, H 80



901565 AMMONIAK

tri proof lamp; plastic, grey / plastic, white
 Feuchtraumleuchte; Kunststoff, grau / Kunststoff, weiss
 Réglette étanche; plastique, gris / plastique, blanc

L 1490, B 85, H 80



901537 SUSPENSION

accessory; steel, silver
 Zubehör; Stahl, silber
 Accessoires; acier, argent

H 1500

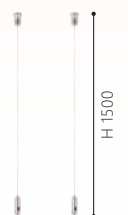





EGLO EXPERT

UNDERCABINET LUMINAIRES

ADVANTAGES

- > **POPULAR LIGHTING OPTION** - for wardrobes, cupboards, kitchens, bedrooms (reading area), caravans etc.
- > **DIRECT LIGHTING OF WORK SURFACES** - a well-lit environment makes working in the kitchen easier and improves visibility by installing under wall units and direct lighting on work surfaces
- > **IMPROVED VISIBILITY** - more precise performance of cooking activities and prevention of accidents thanks to better visibility of food, cooking utensils and tools with the help of targeted lighting of work areas
- > **AMBIENCE AND MOOD LIGHTING** - various lighting options, including dimmable LEDs and colour-changing options, create a pleasant atmosphere in rooms and adapt the lighting to the mood as required
- > **SPACE** - saving design - by mounting directly under the wall units, no additional space is taken up, ensuring a clean and tidy aesthetic in the kitchen

VORTEILE

- > **BELIEBTE BELEUCHTUNGSOPTION** - für Garderoben, Schränke, Küchen, Schlafzimmer (Lesebereich), Wohnwägen etc.
- > **DIREKTE BELEUCHTUNG VON ARBEITSFLÄCHEN** - gut beleuchtete Umgebung erleichtert das Arbeiten in der Küche und verbessert die Sicht durch die Installation unter Hängeschränken und direkter Beleuchtung auf Arbeitsflächen
- > **VERBESSERTE SICHTBARKEIT** - präzisere Durchführung von Kochaktivitäten und Vermeidung von Unfällen durch bessere Sicht auf Lebensmittel, Kochutensilien und Arbeitsgeräten mithilfe gezielter Beleuchtung von Arbeitsbereichen
- > **AMBIENTE UND STIMMUNGSBELEUCHTUNG** - verschiedene Beleuchtungsoptionen, einschließlich dimmbarer LEDs und Farbwechsellmöglichkeiten, schaffen eine angenehme Atmosphäre in Räumlichkeiten und passen das Beleuchten der Stimmung nach Bedarf an
- > **PLATZSPARENDES DESIGN** - durch Montage direkt unter den Hängeschränken wird kein zusätzlicher Platz in beansprucht, sorgt für saubere und ordentliche Ästhetik in der Küche

AVANTAGES

- > **OPTION D'ÉCLAIRAGE POPULAIRE** - pour les penderies, les armoires, les cuisines, les chambres (zone de lecture), les caravanes, etc.
- > **ÉCLAIRAGE DIRECT DES PLANS DE TRAVAIL** - un environnement bien éclairé facilite le travail dans la cuisine et améliore la visibilité grâce à l'installation sous les armoires suspendues et à l'éclairage direct des plans de travail
- > **AMÉLIORATION DE LA VISIBILITÉ** - les activités culinaires sont plus précises et les accidents sont évités grâce à une meilleure visibilité des aliments, des ustensiles de cuisine et des outils de travail grâce à un éclairage ciblé des zones de travail
- > **AMBIANCE ET ÉCLAIRAGE D'AMBIANCE** - différentes options d'éclairage, y compris des LED à intensité variable et des possibilités de changement de couleur, créent une atmosphère agréable dans les locaux et adaptent l'éclairage à l'ambiance selon les besoins
- > **DESIGN PEU ENCOMBRANT** - le montage directement sous les armoires suspendues n'occupe pas d'espace supplémentaire et garantit une esthétique propre et ordonnée dans la cuisine

OVERVIEW



This product is available in different colors and shapes./ Dieser Artikel ist in unterschiedlichen Farben und Formen verfügbar./
Cet article est disponible en différentes couleurs et formes.



901566



901567



901568



901566 MATTANZA

wall/ceiling light; plastic, white / plastic, white
Wand- / Deckenleuchte; Kunststoff, weiss / Kunststoff, weiss
Applique/Plafonnier; plastique, blanc / plastique, blanc

L 580, B 30, H 40



901567 MATTANZA

wall/ceiling light; plastic, white / plastic, white
Wand- / Deckenleuchte; Kunststoff, weiss / Kunststoff, weiss
Applique/Plafonnier; plastique, blanc / plastique, blanc

L 1180, B 30, H 40



901568 MATTANZA

wall/ceiling light; plastic, white / plastic, white
Wand- / Deckenleuchte; Kunststoff, weiss / Kunststoff, weiss
Applique/Plafonnier; plastique, blanc / plastique, blanc

L 1480, B 30, H 40



9 008606 313518

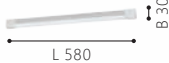

9 008606 313525



9 008606 313532

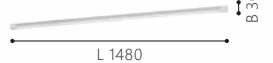



901569

LED



901571

LED



901569 SICCIAROTTA

wall/ceiling light; plastic, white / plastic, white
Wand- / Deckenleuchte; Kunststoff, weiss / Kunststoff, weiss
Applique/Plafonnier; plastique, blanc / plastique, blanc

L 600, B 75, H 25

LED

18 W

neutral
WHITE

1800 lm



901571 SICCIAROTTA

wall/ceiling light; plastic, white / plastic, white
Wand- / Deckenleuchte; Kunststoff, weiss / Kunststoff, weiss
Applique/Plafonnier; plastique, blanc / plastique, blanc

L 1245, B 75, H 25

LED

36 W

neutral
WHITE

3600 lm



9 008606 313549



9 008606 313556





EGLO EXPERT

WALL & CEILING LUMINAIRES

ADVANTAGES

- > **SUITABLE CHOICE FOR VARIOUS ENVIRONMENTS** - IP54 protection rating makes it particularly suitable for outdoor areas or damp rooms (e.g. raw concrete use)
- > **PROTECTION AGAINST DUST** - the first digit in the IP protection class stands for protection against foreign bodies such as dust, IP54 wall lights offer sufficient protection against the ingress of dust particles, increasing their durability and reliability
- > **PROTECTION AGAINST SPLASHING WATER** - second digit in the IP protection class indicates the degree of protection against water, IP54 wall lights offer protection against splashing water from all directions, ideal for use in humid environments such as bathrooms, kitchens or outdoor areas where they may be exposed to rain
- > **ROBUST DESIGN** - IP54 EGLO Expert wall luminaires are robustly built and can withstand the rigours of the environment, housing made from weather resistant materials resists corrosion and wear and tear
- > **VERSATILE APPLICATIONS** - UV-resistant, dust and splash water protection makes them suitable for a wide range of applications, both indoors and outdoors, e.g. corridors, stairwells, gardens, terraces, balconies and garages

VORTEILE

- > **GEEIGNETE WAHL FÜR VERSCHIEDENE UMGEBUNGEN** - durch Schutzgrad IP54 besonders für Außenbereiche oder Feuchträume (z.B. Rohbetoneinsatz) geeignet
- > **SCHUTZ VOR STAUB** - erste Ziffer in der IP-Schutzklasse steht für den Schutz vor Fremdkörpern wie Staub, IP54 Wandleuchten bieten ausreichenden Schutz vor Eindringen von Staubpartikeln, erhöht ihre Haltbarkeit und Zuverlässigkeit
- > **SCHUTZ VOR SPRITZWASSER** - zweite Ziffer in der IP-Schutzklasse gibt den Schutzgrad gegen Wasser an, IP54 Wandleuchten bieten Schutz gegen Spritzwasser aus allen Richtungen, ideal für den Einsatz in feuchten Umgebungen wie Badezimmern, Küchen oder Außenbereichen, wo sie Regen ausgesetzt sein können
- > **ROBUSTES DESIGN** - IP54 EGLO Expert Wandleuchten sind robust gebaut und können den Belastungen der Umgebung standhalten, Gehäuse aus wetterbeständigen Materialien widersteht Korrosion und Verschleiß
- > **VIELSEITIGE ANWENDUNGSMÖGLICHKEITEN** - UV-beständig, durch Schutz gegen Staub und Spritzwasser geeignet für eine Vielzahl von Anwendungen, sowohl im Innen- als auch im Außenbereich, z. B. Flure, Treppenhäuser, Gärten, Terrassen, Balkone und Garagen

AVANTAGES

- > **CHOIX ADAPTÉ À DIFFÉRENTS ENVIRONNEMENTS** - grâce à l'indice de protection IP54, elles sont particulièrement adaptées aux espaces extérieurs ou humides (par ex. utilisation de béton brut).
- > **PROTECTION CONTRE LA POUSSIÈRE** - le premier chiffre de la classe de protection IP indique la protection contre les corps étrangers comme la poussière, les appliques murales IP54 offrent une protection suffisante contre la pénétration de particules de poussière, ce qui augmente leur durabilité et leur fiabilité.
- > **PROTECTION CONTRE LES PROJECTIONS D'EAU** - le deuxième chiffre de la classe IP indique le degré de protection contre l'eau, les appliques murales IP54 offrent une protection contre les projections d'eau de toutes les directions, idéales pour une utilisation dans des environnements humides comme les salles de bains, les cuisines ou les espaces extérieurs où elles peuvent être exposées à la pluie.
- > **DESIGN ROBUSTE** - les appliques EGLO Expert IP54 sont de construction robuste et peuvent résister aux contraintes de l'environnement, le boîtier en matériaux résistants aux intempéries résiste à la corrosion et à l'usure
- > **APPLICATIONS MULTIPLES** - résistantes aux UV, adaptées à une multitude d'applications intérieures et extérieures grâce à une protection contre la poussière et les projections d'eau, par ex. couloirs, cages d'escalier, jardins, terrasses, balcons et garages

OVERVIEW



This product is available in different colors and shapes./ Dieser Artikel ist in unterschiedlichen Farben und Formen verfügbar./
Cet article est disponible en différentes couleurs et formes.



901524



IP54



901525



IP54



901527



360°, 5-10 m
5 sec.-3 min.



IP54

901524 APPRODO

wall/ceiling light; steel, white / plastic, white
Wand- / Deckenleuchte; Stahl, weiss / Kunststoff, weiss
Applique/Plafonnier; acier, blanc / plastique, blanc

H 55, Ø 260



12 W



1750 lm



IP54



9 008606 313143



Ø 260

901525 APPRODO

wall/ceiling light; steel, white / plastic, white
Wand- / Deckenleuchte; Stahl, weiss / Kunststoff, weiss
Applique/Plafonnier; acier, blanc / plastique, blanc

H 55, Ø 310



18 W



2250 lm



IP54



9 008606 313150



Ø 310

901527 APPRODO

wall/ceiling light; steel, white / plastic, white
Wand- / Deckenleuchte; Stahl, weiss / Kunststoff, weiss
Applique/Plafonnier; acier, blanc / plastique, blanc

H 55, Ø 310



18 W



2250 lm



IP54



9 008606 313174



Ø 310



901526



901529



901528



901526 APPRODO

wall/ceiling light; steel, white / plastic, white
Wand- / Deckenleuchte; Stahl, weiss / Kunststoff, weiss
Applique/Plafonnier; acier, blanc / plastique, blanc

H 70, Ø 430



36W

4600lm

IP54



9 008606 313167

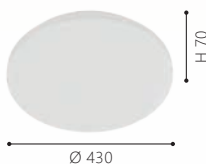

901529 MARGIDORE

wall/ceiling light; steel, white / plastic, white, black
Wand- / Deckenleuchte; Stahl, weiss / Kunststoff, weiss, schwarz
Applique/Plafonnier; acier, blanc / plastique, blanc, noir

H 65, Ø 340



18W

2250lm

IP54



9 008606 313198



901528 MARGIDORE

wall/ceiling light; steel, white / plastic, white, satin nickel
Wand- / Deckenleuchte; Stahl, weiss / Kunststoff, weiss, nickel-matt
Applique/Plafonnier; acier, blanc / plastique, blanc, nickel mat

H 65, Ø 340



18W

2250lm

IP54



9 008606 313181

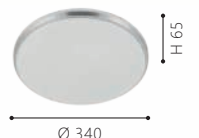



901577



IP54



901576



IP54

901576 MINERARIO

ceiling light; plastic, white / plastic, white
 Deckenleuchte; Kunststoff, weiss / Kunststoff, weiss
 plafonnier; plastique, blanc / plastique, blanc

H 30, Ø 300



14,4W



1800lm



IP54



9 008606 313600





901572



901577



901573



901572 MINERARIO

ceiling light; plastic, black / plastic, white
Deckenleuchte; Kunststoff, schwarz / Kunststoff, weiss
plafonnier; plastique, noir / plastique, blanc

H 30, Ø 300



901577 MINERARIO

ceiling light; plastic, white / plastic, white
Deckenleuchte; Kunststoff, weiss / Kunststoff, weiss
plafonnier; plastique, blanc / plastique, blanc

H 30, Ø 390



901573 MINERARIO

ceiling light; plastic, black / plastic, white
Deckenleuchte; Kunststoff, schwarz / Kunststoff, weiss
plafonnier; plastique, noir / plastique, blanc

H 30, Ø 390



9 008606 313563

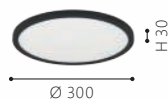

9 008606 313617



9 008606 313570





901574



901578



901574



901578 MINERARIO

ceiling light; plastic, white / plastic, white
 Deckenleuchte; Kunststoff, weiss / Kunststoff, weiss
 plafonnier; plastique, blanc / plastique, blanc

L 290, B 290, H 30



14,4W



2000lm



IP54



901574 MINERARIO

ceiling light; plastic, black / plastic, white
 Deckenleuchte; Kunststoff, schwarz / Kunststoff, weiss
 plafonnier; plastique, noir / plastique, blanc

L 290, B 290, H 30



14,4W



2000lm



IP54



9 008606 313624



9 008606 313587





901579



901575



901579 MINERARIO

ceiling light; plastic, white / plastic, white
Deckenleuchte; Kunststoff, weiss / Kunststoff, weiss
plafonnier; plastique, blanc / plastique, blanc

L 390, B 390, H 30



21W



3000lm



IP54



901575 MINERARIO

ceiling light; plastic, black / plastic, white
Deckenleuchte; Kunststoff, schwarz / Kunststoff, weiss
plafonnier; plastique, noir / plastique, blanc

L 390, B 390, H 30



21W



3000lm



IP54



9 008606 313631



9 008606 313594





EGLO EXPERT TUBES

ADVANTAGES

- > **RANGE OF ADVANTAGES** - compared to conventional fluorescent tubes
- > **ENERGY EFFICIENCY** - consume up to 50-60% less electricity than conventional fluorescent tubes, resulting in significant savings in energy costs
- > **LONGER LIFE** - much longer life compared to fluorescent tubes, reducing the need for frequent replacements and reducing maintenance costs
- > **LOWER HEAT GENERATION** - lower heat generation than fluorescent tubes increases efficiency and reduces susceptibility to overheating
- > **NO FLICKERING** - instant and constant illumination without flickering, unlike fluorescent tubes which can flicker and require a warm-up time to reach brightness
- > **NO QUECKSILVER** - LED tubes contain no mercury - unlike old fluorescent tubes, making disposal easier
- > **FLEXIBILITY OF USE** - due to the different sizes, color temperatures and light intensities, it is suitable for a variety of luminaires, can be easily installed in existing fluorescent tube sockets using the included LED Starter, enable simple and cost-effective conversion, an energy-efficient, long-lasting, environmentally friendly and versatile lighting solution
- > **ONLY FOR KVG LUMINAIRES** - only to be used with conventional ballasts

VORTEILE

- > **REIHE VON VORTEILEN** - gegenüber herkömmlichen Leuchtstoffröhren
- > **ENERGIEEFFIZIENZ** - verbrauchen bis zu 50-60% weniger Strom als konventionelle Leuchtstoffröhren, führt zu erheblichen Einsparungen bei den Energiekosten
- > **LÄNGERE LEBENSDAUER** - viel längere Lebensdauer im Vergleich zu Leuchtstoffröhren, reduziert die Notwendigkeit häufiger Austausche und verringert Wartungskosten
- > **GERINGERE WÄRMEENTWICKLUNG** - geringere Wärmeentwicklung als bei Leuchtstoffröhren steigert die Effizienz und mindert die Anfälligkeit für Überhitzung
- > **KEIN FLACKERN** - sofortige und konstante Beleuchtung ohne Flackern, anders als Leuchtstoffröhren, die flackern können und eine Aufwärmzeit benötigen um ihre Helligkeit zu erreichen
- > **KEIN QUECKSILBER** - LED Röhren enthalten kein Quecksilber - anders als alte Leuchtstoffröhren, erleichtert die Entsorgung
- > **FLEXIBILITÄT IN DER ANWENDUNG** - aufgrund der verschiedenen Größen, Farbtemperaturen und Lichtstärken für eine Vielzahl an Leuchten geeignet, können mithilfe des beigepackten LED Starters problemlos in bestehende Leuchtstoffröhren-Fassungen installiert werden, ermöglichen einfache und kostengünstige Umstellung, eine energieeffiziente, langlebige, umweltfreundliche und vielseitige Beleuchtungslösung
- > **NUR FÜR KVG LEUCHTEN** - nur für konventionelle Vorschaltgeräte zu verwenden

AVANTAGES

- > **UNE SÉRIE D'AVANTAGES** - par rapport aux tubes fluorescents conventionnels
- > **EFFICACITÉ ÉNERGÉTIQUE** - consomment jusqu'à 50-60% d'électricité en moins que les tubes fluorescents conventionnels, ce qui permet de réaliser des économies d'énergie substantielles.
- > **DURÉE DE VIE PLUS LONGUE** - durée de vie beaucoup plus longue que celle des tubes fluorescents, réduit la nécessité de remplacements fréquents et diminue les coûts de maintenance.
- > **MOINS DE CHALEUR** - la chaleur générée est inférieure à celle des tubes fluorescents, ce qui augmente l'efficacité et réduit le risque de surchauffe
- > **PAS DE SCINTILLEMENT** - éclairage instantané et constant sans scintillement, contrairement aux tubes fluorescents qui peuvent scintiller et nécessitent un temps de préchauffage pour atteindre leur luminosité.
- > **PAS DE MERCURE** - Les tubes LED ne contiennent pas de mercure, contrairement aux anciens tubes fluorescents, ce qui facilite leur élimination
- > **FLEXIBILITÉ D'APPLICATION** - convient à une grande variété de luminaires grâce aux différentes tailles, températures de couleur et intensités lumineuses, s'installe facilement dans les douilles de tubes fluorescents existantes à l'aide du starter LED fourni, permet une conversion simple et économique, une solution d'éclairage efficace en énergie, durable, écologique et polyvalente
- > **UNIQUEMENT POUR LES LUMINAIRES À BALLAST ÉLECTRONIQUE** - à utiliser uniquement avec des ballasts conventionnels

OVERVIEW



LM_LED_G13
86-91



This product is available in different colors and shapes./ Dieser Artikel ist in unterschiedlichen Farben und Formen verfügbar./
Cet article est disponible en différentes couleurs et formes.

110339 G13-LED-T8-TUBE



1650 lm

neutral
WHITE

4000 K



L 590, Ø 28



not dimmable



10 W



10



220-240V, 50/60Hz



G13



9 008606 313068

110341 G13-LED-T8-TUBE



2500 lm

neutral
WHITE

4000 K



L 1214, Ø 28



not dimmable



15 W



10



220-240V, 50/60Hz



G13



9 008606 313075

110342 G13-LED-T8-TUBE



3700 lm

neutral
WHITE

4000 K



L 1514, Ø 28



not dimmable



23 W



10



220-240V, 50/60Hz



G13



9 008606 313082

110347 G13-LED-T8-TUBE



L 1214, Ø 28	not dimmable
15 W	10
220-240V, 50/60Hz	Motion Sensor
G13	



110348 G13-LED-T8-TUBE

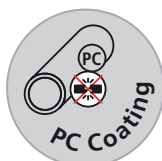

L 1514, Ø 28	not dimmable
23 W	10
220-240V, 50/60Hz	Motion Sensor
G13	



G13-LED-T8-TUBE

Shatterproof – These articles are encased in a plastic cover and therefore break-resistant.









Bruchhemmend – Diese Artikel sind mit einer Kunststoffhülle umgeben und dadurch bruchhemmend.

Résistants à la rupture - Ces articles sont enveloppés d'une housse en plastique et sont donc résistants à la casse.



110337 G13-LED-T8-TUBE











 1700 lm	warm WHITE 3000 K	
 L 1214, Ø 28	 not dimmable	
 15 W	 10	
 220-240V, 50/60Hz		
 G13		



110338 G13-LED-T8-TUBE



 2600 lm	warm WHITE 3000 K	
 L 1514, Ø 28	 not dimmable	
 23 W	 10	
 220-240V, 50/60Hz		
 G13		



110349 G13-LED-T8-TUBE



1100 lm

neutral
WHITE

4000 K



L 590, Ø 28



not dimmable



10 W



220-240V, 50/60Hz



G13



9 008606 325894

110343 G13-LED-T8-TUBE



1700 lm

neutral
WHITE

4000 K



L 1214, Ø 28



not dimmable



15 W



10



220-240V, 50/60Hz



G13



9 008606 313006

110344 G13-LED-T8-TUBE



2600 lm

neutral
WHITE

4000 K



L 1514, Ø 28



not dimmable



23 W



10



220-240V, 50/60Hz











G13



9 008606 313013

110345 G13-LED-T8-TUBE











 1700 lm	cold WHITE 6500 K	
 L 1214, Ø 28	 not dimmable	
 15 W	 10	
 220-240V, 50/60Hz		
 G13		



110346 G13-LED-T8-TUBE



 2600 lm	cold WHITE 6500 K	
 L 1514, Ø 28	 not dimmable	
 23 W	 10	
 220-240V, 50/60Hz		
 G13		





KITCHEN & FUNCTIONAL LUMINAIRES

ADVANTAGES

- > PERFECT ADDITION TO THE KITCHEN AREA AND OPTIMUM LIGHTING OPTION
 - > CREATE IDEAL LIGHTING CONDITIONS FOR VARIOUS KITCHEN ACTIVITIES
 - > ENSURE OPTIMUM ILLUMINATION OF WORK SURFACES AND THUS BECOME AN EVERYDAY AID
 - > UNDER-CABINET LUMINAIRES CREATE A PLEASANT ATMOSPHERE IN THE LIVING AREA
-

VORTEILE

- > PERFEKTE ERGÄNZUNG FÜR DEN KÜCHENBEREICH UND OPTIMALE BELEUCHTUNGSMÖGLICHKEIT
 - > SCHAFFEN IDEALE LICHTVERHÄLTNISSE FÜR VERSCHIEDENE KÜCHENAKTIVITÄTEN
 - > SORGEN FÜR OPTIMALE AUSLEUCHTUNG VON ARBEITSFLÄCHEN UND WERDEN DADURCH ZUR ALLTAGSHILFE
 - > UNTERBAULEUCHTEN SORGEN FÜR EINE ANGENEHME ATMOSPHÄRE IM WOHNRAUM
-

AVANTAGES

- > COMPLÉMENT PARFAIT POUR L'ESPACE CUISINE ET POSSIBILITÉ D'ÉCLAIRAGE OPTIMALE
- > CRÉENT DES CONDITIONS D'ÉCLAIRAGE IDÉALES POUR DIFFÉRENTES ACTIVITÉS EN CUISINE
- > ASSURENT UN ÉCLAIRAGE OPTIMAL DES PLANS DE TRAVAIL ET DEVIENNENT AINSI UNE AIDE AU QUOTIDIEN
- > LES LUMINAIRES SOUS PLAN CRÉENT UNE ATMOSPHÈRE AGRÉABLE DANS LA PIÈCE À VIVRE

OVERVIEW



This product is available in different colors and shapes./ Dieser Artikel ist in unterschiedlichen Farben und Formen verfügbar./
Cet article est disponible en différentes couleurs et formes.

DESIGN
HIGHLIGHT
DETAIL



97572

LED



97573

LED



97574

LED

97572 DUNDRY

wall/ceiling light; plastic, white / plastic, white
Wand- / Deckenleuchte; Kunststoff, weiss / Kunststoff, weiss
Applique/Plafonnier; plastique, blanc / plastique, blanc

L 570, B 25, H 35



6,6W 850lm



9 002759 975722



97573 DUNDRY

wall/ceiling light; plastic, white / plastic, white
Wand- / Deckenleuchte; Kunststoff, weiss / Kunststoff, weiss
Applique/Plafonnier; plastique, blanc / plastique, blanc

L 870, B 25, H 35



9,3W 1250lm



9 002759 975739

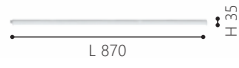

97574 DUNDRY

wall/ceiling light; plastic, white / plastic, white
Wand- / Deckenleuchte; Kunststoff, weiss / Kunststoff, weiss
Applique/Plafonnier; plastique, blanc / plastique, blanc

L 1170, B 25, H 35



12,8W 1700lm



9 002759 975746





97571

LED



97571

LED

97571 DUNDRY

wall/ceiling light; plastic, white / plastic, white
 Wand- / Deckenleuchte; Kunststoff, weiss / Kunststoff, weiss
 Applique/Plafonnier; plastique, blanc / plastique, blanc

L 310, B 25, H 35

LED

3,7W

neutral
WHITE

450lm



9 002759 975715





96081



96081

Mounting type: incl. mounting clips, Switch type: sensor switch (on/off).

Befestigungsart: inkl. Montageclips, Schalterart: Sensor Schalter (ein/aus).

Type de fixation : clips de montage inclus, Type de interrupteur : interrupteur capteur (on/off).



96081



0,15m



93707



93706



96081 TEYA

under cabinet light; aluminium, silver / plastic, white
 Unterbauleuchte; Alu, silber / Kunststoff, weiss
 éclairage de meuble; aluminium, argent / plastique, blanc

L 600, B 55, H 25



10W



950lm



93707 KOB LED

under cabinet light; steel, satin nickel
 Unterbauleuchte; Stahl, nickel-matt
 éclairage de meuble; acier, nickel mat

L 600, B 70, H 25



3x 2,3W



840lm



93706 KOB LED

under cabinet light; steel, white
 Unterbauleuchte; Stahl, weiss
 éclairage de meuble; acier, blanc

L 600, B 70, H 25



3x 2,3W



840lm



9 002759 960810



L 600



9 002759 937072



L 600



9 002759 937065



L 600

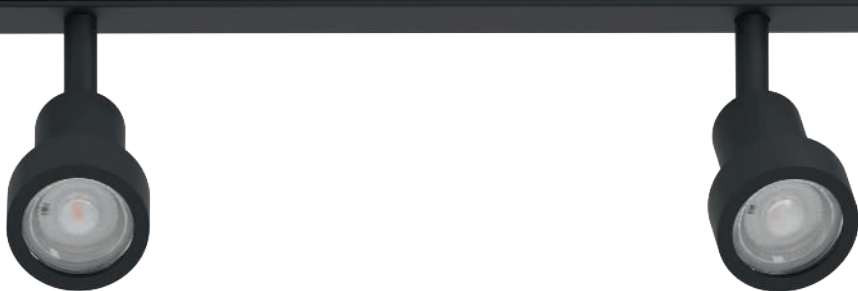

TRACK SYSTEM

ADVANTAGES

- > **EASY TRACK** - DESIGNED TO ENHANCE ANY SPACE'S AMBIANCE AND FUNCTIONALITY, THIS NEW HIGH VOLTAGE TRACK SYSTEM OFFERS ACCESSIBLE AND PRACTICAL SOLUTION FOR YOUR HOME. A SIMPLE OFFER, UNLIMITED POSSIBILITIES, ATTRACTIVE PRICE AND ACCESSORIES FULLY INTEGRATED INTO THE METAL TRACK BRING NOVELTY TO THE TRACK MARKET.
 - > **TRACK PLUS** - THIS EXTRA-FLAT TRACK TAKES THE TRACK SYSTEM TO ANOTHER LEVEL. PERFECT FOR WALL AND CEILING MOUNTING, THIS TRACK CAN BE INTEGRATED ANYWHERE. SET THE CCT AND BRIGHTNESS LEVEL OF YOUR ACCESSORIES AS YOU LIKE WITH THE INCLUDED REMOTE CONTROL AND MANAGE YOUR PRODUCTS IN 2 DIFFERENT GROUPS FOR GREATER FLEXIBILITY.
-

VORTEILE

- > **EASY TRACK** - ENTWICKELT, UM DAS AMBIENTE UND DIE FUNKTIONALITÄT EINES JEDEN RAUMES ZU VERBESSERN, BIETET DIESES NEUE HOCHSPANNUNGSSCHIENENSYSTEM EINE ZUGÄNGLICHE UND PRAKTISCHE LÖSUNG FÜR IHR ZUHAUSE. EIN EINFACHES ANGEBOT, UNBEGRENZTE MÖGLICHKEITEN, EIN ATTRAKTIVER PREIS UND VOLLSTÄNDIG IN DIE METALLSCHIENE INTEGRIERTES ZUBEHÖR BRINGEN EINE NEUHEIT AUF DEN SCHIENENMARKT.
 - > **TRACK PLUS** - DIESE EXTRAFLACHE SCHIENE HEBT DAS SCHIENENSYSTEM AUF EINE NEUE EBENE. PERFEKT FÜR DIE WAND- UND DECKENMONTAGE, KANN DIESE SCHIENE ÜBERALL INTEGRIERT WERDEN. MIT DER MITGELIEFERTEN FERNBEDIENUNG KÖNNEN SIE DIE FARBTEMPERATUR UND DIE HELLGHEIT IHRES ZUBEHÖRS NACH BELIEBEN EINSTELLEN UND IHRE PRODUKTE IN 2 VERSCHIEDENEN GRUPPEN VERWALTEN, UM MEHR FLEXIBILITÄT ZU ERREICHEN.
-

AVANTAGES

- > **EASY TRACK** - CONÇU POUR AMÉLIORER L'AMBIANCE ET LA FONCTIONNALITÉ DE TOUT ESPACE, CE NOUVEAU SYSTÈME DE RAIL HAUTE TENSION OFFRE UNE SOLUTION ACCESSIBLE ET PRATIQUE POUR VOTRE MAISON. UNE OFFRE SIMPLE, DES POSSIBILITÉS ILLIMITÉES, UN PRIX ATTRACTIF ET DES ACCESSOIRES ENTIÈREMENT INTÉGRÉS DANS LE RAIL MÉTALLIQUE APPORTENT DE LA NOUVEAUTÉ SUR LE MARCHÉ DES RAILS.
- > **TRACK PLUS** - CE RAIL EXTRA-PLAT FAIT PASSER LE SYSTÈME DE RAIL À UN AUTRE NIVEAU. PARFAIT POUR UN MONTAGE MURAL OU AU PLAFOND, CE RAIL PEUT ÊTRE INTÉGRÉ PARTOUT. RÉGLEZ LE CCT ET LE NIVEAU DE LUMINOSITÉ DE VOS ACCESSOIRES COMME VOUS LE SOUHAITEZ À L'AIDE DE LA TÉLÉCOMMANDE FOURNIE ET GÉREZ VOS PRODUITS DANS 2 GROUPES DIFFÉRENTS POUR UNE PLUS GRANDE FLEXIBILITÉ.





TRACK SYSTEM

EASY TRACK

ADVANTAGES

- > EASY CEILING AND PENDANT MOUNTING
- > FLEXIBLE USAGE WITH GU10
- > SEAMLESS DESIGN
- > ENTRY-LEVEL PRICE
- > SIMPLIFIED OFFER, EASY TO UNDERSTAND FOR END CONSUMER
- > EASY INSTALLATION
- > QUICK ASSEMBLY AND DISASSEMBLY OF ACCESSORIES FOR EASY MAINTENANCE AND CUSTOMIZATION

VORTEILE

- > EINFACHE DECKEN- UND PENDELMONTAGE
- > FLEXIBLER EINSATZ MIT GU10
- > NAHTLOSES DESIGN
- > EINSTIEGSPREIS
- > VEREINFACHTES, FÜR DEN ENDVERBRAUCHER LEICHT VERSTÄNDLICHES ANGEBOT
- > EINFACHE INSTALLATION
- > SCHNELLE MONTAGE UND DEMONTAGE DES ZUBEHÖRS FÜR EINFACHE WARTUNG UND ANPASSUNG

AVANTAGES

- > MONTAGE FACILE AU PLAFOND ET EN SUSPENSION
- > UTILISATION FLEXIBLE AVEC GU10
- > DESIGN HOMOGENE
- > PRIX D'ENTRÉE DE GAMME
- > OFFRE SIMPLIFIÉE, FACILE À COMPRENDRE POUR LE CONSOMMATEUR FINAL
- > INSTALLATION FACILE
- > MONTAGE ET DÉMONTAGE RAPIDES DES ACCESSOIRES POUR UNE MAINTENANCE ET UNE PERSONNALISATION AISÉES

OVERVIEW

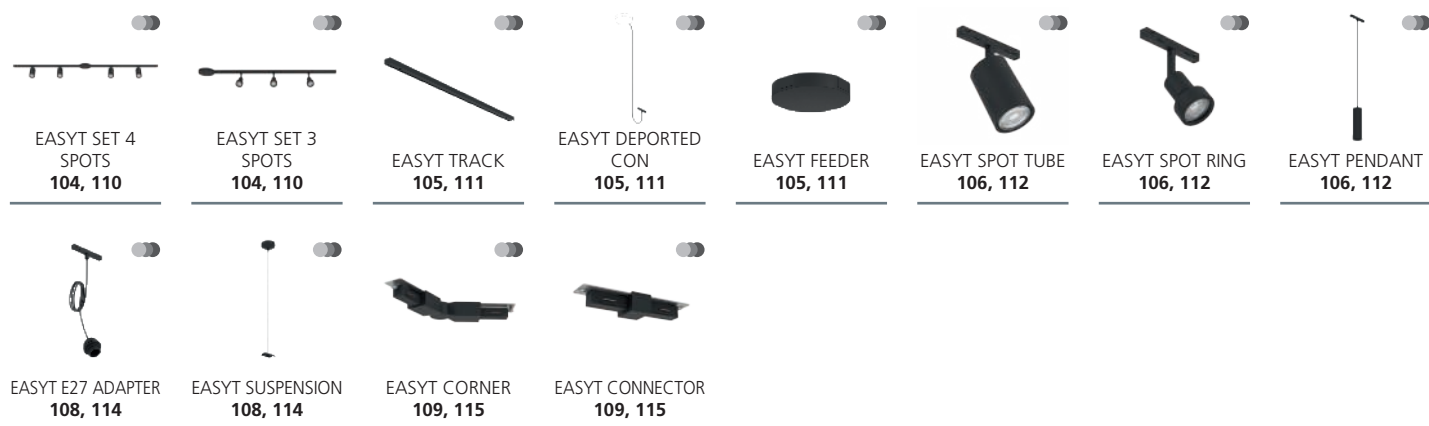

 This product is available in different colors and shapes./ Dieser Artikel ist in unterschiedlichen Farben und Formen verfügbar./
Cet article est disponible en différentes couleurs et formes.

SEAMLESS INTEGRATION /
NAHTLOSE INTEGRATION /
INTÉGRATION TRANSPARENTE



Experience seamless design with integrated track spots. / Erleben Sie nahtloses Design mit in die Schiene integrierten Spots. / Découvrez une conception sans faille avec des spots de piste intégrés.



Customize your lighting experience by fitting your preferred GU10 bulb into our versatile models. With three light sources to choose from, you can create the perfect ambiance for your home. Rotate the spots to adjust the direction of light as desired. Use the E27 Adapter to extend your track with your preferred shade.

Passen Sie Ihr Lichtelebnis an, indem Sie Ihre bevorzugte GU10-Lampe in unsere vielseitigen Modelle einsetzen. Mit den drei zur Auswahl stehenden Lichtquellen können Sie das perfekte Ambiente für Ihr Zuhause schaffen. Drehen Sie die Spots, um die Lichtrichtung nach Wunsch einzustellen. Verwenden Sie den E27-Adapter, um Ihre Schiene mit Ihrem bevorzugten Lampenschirm zu erweitern.

Personnalisez votre expérience d'éclairage en installant l'ampoule GU10 de votre choix dans nos modèles polyvalents. Avec trois sources de lumière au choix, vous pouvez créer l'ambiance parfaite pour votre maison. Faites pivoter les spots pour ajuster la direction de la lumière comme vous le souhaitez. Utilisez l'adaptateur E27 pour prolonger votre rail avec l'abat-jour de votre choix.

FEW CONNECTORS, INFINITE POSSIBILITIES / WENIGE STECKVERBINDER, UNENDLICHE MÖGLICHKEITEN / PEU DE CONNECTEURS, DES POSSIBILITÉS INFINIES

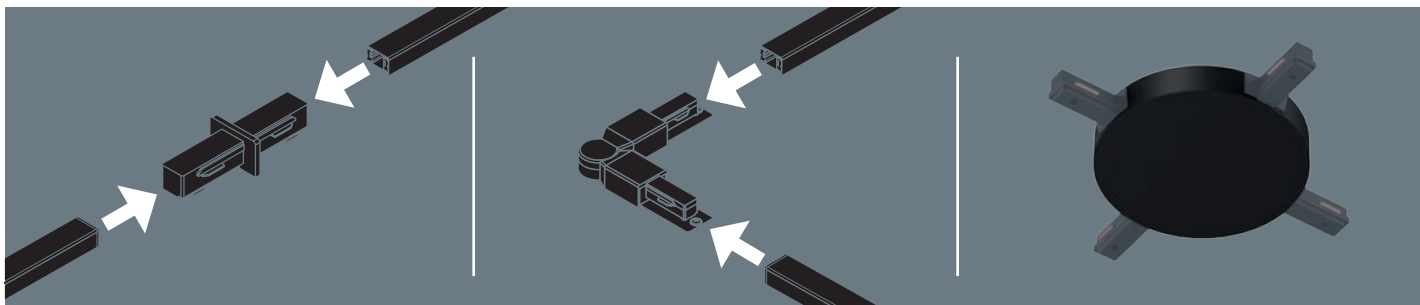

Utilize the basic straight connector to expand your track system.

Nutzen Sie den einfachen, geraden Verbinder, um Ihr Schienensystem zu erweitern.

Utilisez le connecteur droit de base pour étendre votre système de rails.

The corner connector not only creates an L-shaped connection but also accommodates angles ranging from 30 to 180 degrees.

Der Eckverbinder schafft nicht nur eine L-förmige Verbindung, sondern ermöglicht auch Winkel von 30 bis 180 Grad.

Le connecteur angulaire permet non seulement de créer une connexion en forme de L, mais aussi d'accommoder des angles allant de 30 à 180 degrés.

The versatile All-in-one Feeder functions as both a middle or side feeder and serves as a connector to create L, T or X connections.

Der vielseitige All-in-one Feeder fungiert sowohl als mittlerer oder seitlicher Einspeiser als auch als Verbinder, um L-, T- oder X-Verbindungen herzustellen.

L'alimentateur polyvalent Tout-en-un sert à la fois d'alimentateur central ou latéral et de connecteur pour créer des connexions en L, T ou en X.

MODULAR SOLUTION / MODULARE LÖSUNG / SOLUTION MODULAIRE



Extendable according your wish, you can choose to go for a ceiling or a pendant track installation with our deported connector for the power supply and the suspension Kit.

Je nach Wunsch erweiterbar, können Sie sich für eine Decken- oder Hängeschieneninstallation mit unserem deportierten Anschluss für die Stromversorgung und das Aufhängeset entscheiden.

Extensible à souhait, vous pouvez opter pour une installation en plafond ou en suspension avec notre connecteur déporté pour l'alimentation et le kit de suspension.



901652



EASYT SET 4 SPOTS

Individually customizable.

Individuell anpassbar.

Personnalisable individuellement.



901653

901652 EASYT SET 4 SPOTS

system; aluminium, plastic, black / plastic, black
System; Alu, Kunststoff, schwarz / Kunststoff, schwarz
système; aluminium, plastique, noir / plastique, noir

L 1925, B 55, H 140



GU10



4x 35W



9 008606 323371

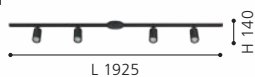

901653 EASYT SET 3 SPOTS

system; aluminium, plastic, black / plastic, black
System; Alu, Kunststoff, schwarz / Kunststoff, schwarz
système; aluminium, plastique, noir / plastique, noir

L 1020, B 55, H 140



GU10



3x 35W



9 008606 323388

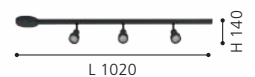

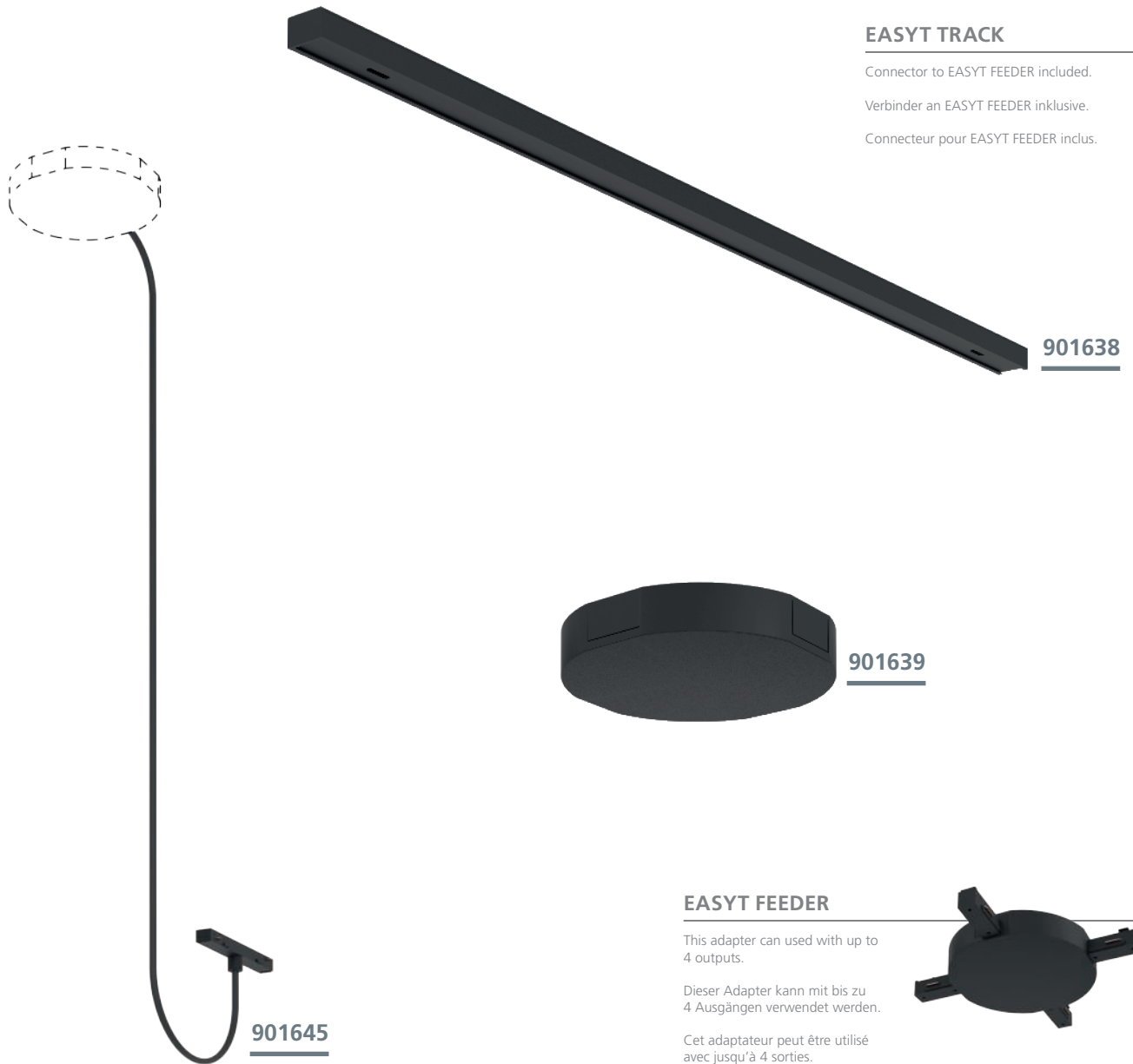

EASY TRACK

Connector to EASYT FEEDER included.
 Verbinder an EASYT FEEDER inklusive.
 Connecteur pour EASYT FEEDER inclus.

EASYT FEEDER

This adapter can be used with up to 4 outputs.
 Dieser Adapter kann mit bis zu 4 Ausgängen verwendet werden.
 Cet adaptateur peut être utilisé avec jusqu'à 4 sorties.

901638 EASY TRACK

accessory; aluminium, black
 Zubehör; Alu, schwarz
 Accessoires; aluminium, noir

L 900, B 30, H 18

901645 EASYT DEPORTED CON

accessory; plastic, black
 Zubehör; Kunststoff, schwarz
 Accessoires; plastique, noir

L 120, H 1200, Ø 58

901639 EASYT FEEDER

accessory; plastic, black
 Zubehör; Kunststoff, schwarz
 Accessoires; plastique, noir

H 20, Ø 120

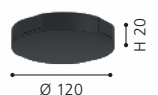
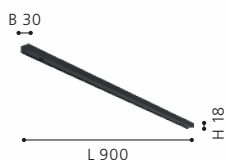



901647



901648



901651

EASYT PENDANT

You can easily shorten the cable of the EASYT PENDANT yourself.

Das Kabel der EASYT PENDANT Hängeleuchte kann einfach selbst gekürzt werden.

Le câble de la suspension EASYT PENDANT peut être facilement raccourci par l'utilisateur.

901647 EASYT SPOT TUBE

spot; plastic, black
Spot; Kunststoff, schwarz
spot; plastique, noir

L 120, H 140, Ø 55



GU10 1x 35W



9 008606 323401



901648 EASYT SPOT RING

spot; plastic, black
Spot; Kunststoff, schwarz
spot; plastique, noir

L 120, H 140, Ø 55



GU10 1x 35W



9 008606 323418



901651 EASYT PENDANT

pendant light; plastic, black
Hängeleuchte; Kunststoff, schwarz
luminaire en suspension; plastique, noir

L 120, H 1100, Ø 60



GU10 1x 35W



9 008606 323432







901644

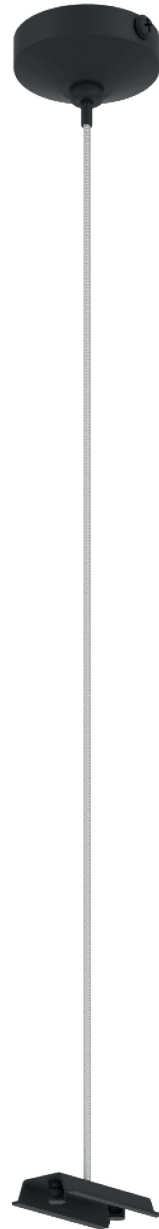

901646

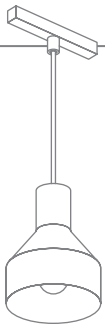

EASYT E27 ADAPTER

Use your own lights! With the EASYT E27 ADAPTER, almost any lampshade can be installed in the track system.

Verwenden Sie Ihre eigenen Leuchten! Mit dem EASYT E27 ADAPTER kann nahezu jeder Lampenschirm im Schienensystem verbaut werden.

Utilisez vos propres luminaires ! Avec EASYT E27 ADAPTER, il est possible d'installer pratiquement n'importe quel abat-jour dans le système de rails.

901644 EASYT E27 ADAPTER

pendant light; plastic, black
 Hängeleuchte; Kunststoff, schwarz
 luminaire en suspension; plastique, noir

L 120, H 1000, Ø 58



E27



1x 40W



9 008606 323487



901646 EASYT SUSPENSION

accessory; plastic, black
 Zubehör; Kunststoff, schwarz
 Accessoires; plastique, noir

H 2000, Ø 50



9 008606 323500



EASYT CORNER

With the EASYT Corner, rails can be connected at an angle of 45° - 180°.

Mit dem EASYT Corner können Schienen im Winkel von 45° - 180° verbunden werden.

L'EASYT Corner permet de relier des rails à un angle de 45° à 180°.



901641 EASYT CORNER

accessory; plastic, black
Zubehör; Kunststoff, schwarz
Accessoires; plastique, noir

L 187, B 30, H 18

901642 EASYT CONNECTOR

accessory; plastic, black
Zubehör; Kunststoff, schwarz
Accessoires; plastique, noir

L 74, B 30, H 18



9 008606 323456



9 008606 323463





901667



EASYT SET 4 SPOTS

Individually customizable.

Individuell anpassbar.

Personnalisable individuellement.



901668

901667 EASYT SET 4 SPOTS

system; aluminium, plastic, white / plastic, white
System; Alu, Kunststoff, weiss / Kunststoff, weiss
système; aluminium, plastique, blanc / plastique, blanc

L 1925, B 55, H 140



GU10



4x 35W



9 008606 323517

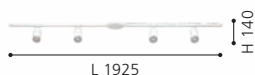

L 1925

901668 EASYT SET 3 SPOTS

system; aluminium, plastic, white / plastic, white
System; Alu, Kunststoff, weiss / Kunststoff, weiss
système; aluminium, plastique, blanc / plastique, blanc

L 1020, B 55, H 140



GU10



3x 35W



9 008606 323524

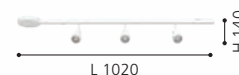

L 1020

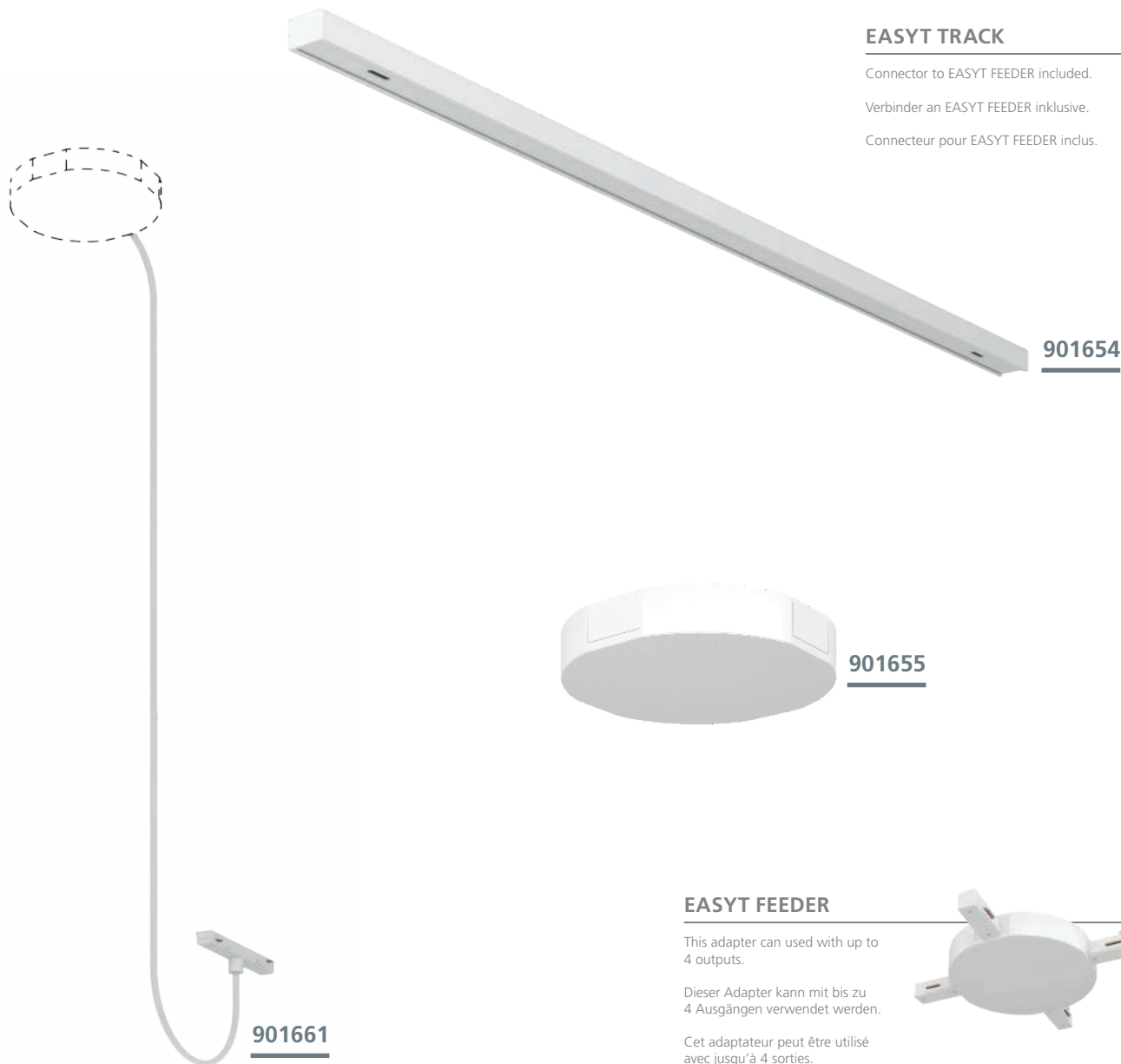

EASYT TRACK

Connector to EASYT FEEDER included.
 Verbinder an EASYT FEEDER inklusive.
 Connecteur pour EASYT FEEDER inclus.

901654

901655

901661

EASYT FEEDER

This adapter can be used with up to 4 outputs.
 Dieser Adapter kann mit bis zu 4 Ausgängen verwendet werden.
 Cet adaptateur peut être utilisé avec jusqu'à 4 sorties.



901654 EASYT TRACK

accessory; aluminium, white
 Zubehör; Alu, weiss
 Accessoires; aluminium, blanc

L 900, B 30, H 18

901661 EASYT DEPORTED CON

accessory; plastic, white
 Zubehör; Kunststoff, weiss
 Accessoires; plastique, blanc

L 120, H 1200, Ø 58

901655 EASYT FEEDER

accessory; plastic, white
 Zubehör; Kunststoff, weiss
 Accessoires; plastique, blanc

H 20, Ø 120

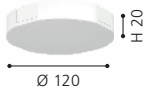
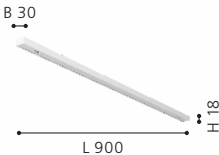



901663



901664



901666

EASYT PENDANT

You can easily shorten the cable of the EASYT PENDANT yourself.

Das Kabel der EASYT PENDANT Hängeleuchte kann einfach selbst gekürzt werden.

Le câble de la suspension EASYT PENDANT peut être facilement raccourci par l'utilisateur.

901663 EASYT SPOT TUBE

spot; plastic, white
Spot; Kunststoff, weiss
spot; plastique, blanc

L 120, H 140, Ø 55



901664 EASYT SPOT RING

spot; plastic, white
Spot; Kunststoff, weiss
spot; plastique, blanc

L 120, H 140, Ø 55



901666 EASYT PENDANT

pendant light; plastic, white
Hängeleuchte; Kunststoff, weiss
luminaire en suspension; plastique, blanc

L 120, H 1100, Ø 60







901659

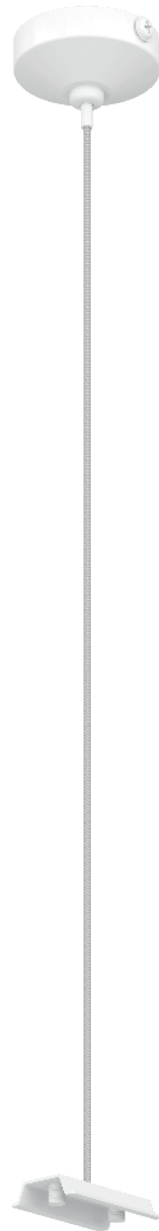

901662

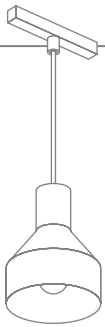

EASYT E27 ADAPTER

Use your own lights! With the EASYT E27 ADAPTER, almost any lampshade can be installed in the track system.

Verwenden Sie Ihre eigenen Leuchten! Mit dem EASYT E27 ADAPTER kann nahezu jeder Lampenschirm im Schienensystem verbaut werden.

Utilisez vos propres luminaires ! Avec EASYT E27 ADAPTER, il est possible d'installer pratiquement n'importe quel abat-jour dans le système de rails.

901659 EASYT E27 ADAPTER

pendant light; plastic, white
 Hängeleuchte; Kunststoff, weiss
 luminaire en suspension; plastique, blanc

L 120, H 1000, Ø 58



E27



1x 40W



9 008606 323623



901662 EASYT SUSPENSION

accessory; plastic, white
 Zubehör; Kunststoff, weiss
 Accessoires; plastique, blanc

H 2000, Ø 50



9 008606 323647



EASYT CORNER

With the EASYT Corner, rails can be connected at an angle of 45° - 180°.

Mit dem EASYT Corner können Schienen im Winkel von 45° - 180° verbunden werden.

L'EASYT Corner permet de relier des rails à un angle de 45° à 180°.

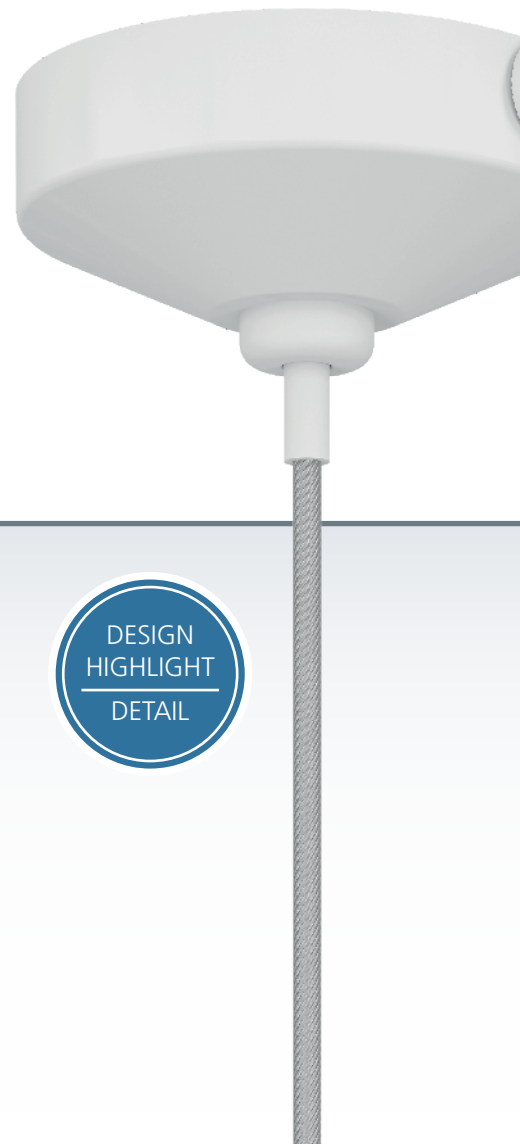
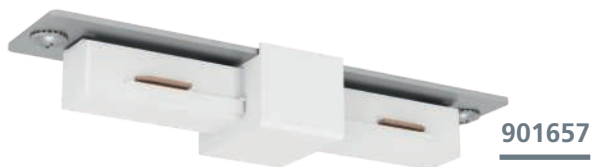

901656 EASYT CORNER

accessory; plastic, white
Zubehör; Kunststoff, weiss
Accessoires; plastique, blanc

L 187, B 30, H 18

901657 EASYT CONNECTOR

accessory; plastic, white
Zubehör; Kunststoff, weiss
Accessoires; plastique, blanc

L 74, B 30, H 18

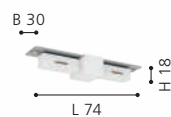
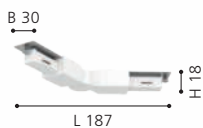



TRACK SYSTEM

TRACK PLUS

ADVANTAGES

- > EXTRA FLAT TRACK (6MM)
 - > WALL AND CEILING MOUNTING
 - > DIMMING AND CCT BY REMOTE
 - > CONTROLLABLE BY GROUP
 - > HIGH LUMEN OUTPUT
 - > MODERN AND INNOVATIVE LIGHTING SOLUTIONS
 - > ABILITY TO CONTROL BRIGHTNESS AND LIGHT COLOR FOR INDIVIDUAL ATMOSPHERES
-

VORTEILE

- > EXTRA FLACHE SCHIENE (6MM)
 - > WAND- UND DECKENMONTAGE
 - > DIMMEN UND STEUERUNG PER FERNBEDIENUNG
 - > GRUPPENWEISE STEUERBAR
 - > HOHER LUMENAUSSSTOSS
 - > MODERNE UND INNOVATIVE LICHTLÖSUNGEN
 - > STEUERUNG VON HELBIGKEIT UND LICHTFARBE FÜR INDIVIDUELLE ATMOSPHÄREN
-

AVANTAGES

- > RAIL EXTRA PLAT (6MM)
- > MONTAGE AU MUR ET AU PLAFOND
- > GRADATION ET CONTRÔLE PAR TÉLÉCOMMANDE
- > CONTRÔLABLE PAR GROUPE
- > RENDEMENT LUMINEUX ÉLEVÉ
- > SOLUTIONS D'ÉCLAIRAGE MODERNES ET INNOVANTES
- > POSSIBILITÉ DE CONTRÔLER LA LUMINOSITÉ ET LA COULEUR DE LA LUMIÈRE POUR DES AMBIANCES PERSONNALISÉES

OVERVIEW



This product is available in different colors and shapes./ Dieser Artikel ist in unterschiedlichen Farben und Formen verfügbar./
Cet article est disponible en différentes couleurs et formes.

MAXIMUM FLEXIBILITY / MAXIMALE FLEXIBILITÄT / FLEXIBILITÉ MAXIMALE



With the TRACK PLUS solution you are able to fulfil multiple use cases:

- › Wall and ceiling installation
- › Use the power supply in deported or directly connected to the track
- › Create L, T and X shapes with the included connectors

Mit der TRACK PLUS-Lösung sind Sie in der Lage, mehrere Anwendungsfälle zu erfüllen:

- › Wand- und Deckenmontage
- › Verwenden Sie die Stromzufuhr versetzt oder direkt an der Schiene angeschlossen
- › Erstellen Sie L-, T- und X-Formen mit den mitgelieferten Verbindern

La solution TRACK PLUS permet de répondre à de multiples cas d'utilisation :

- › Installation au mur et au plafond
- › Utiliser l'alimentation électrique en déporté ou directement connectée au rail
- › Créez des formes en L, T et X avec les connecteurs inclus.

REMOTE CONTROLLABLE / FERNSTEUERBAR / CONTRÔLABLE À DISTANCE

- › Choose a timer (15/30/45 minutes)
- › Dimmable & Lightcolor change
- › Group selection (Group: A, B, A+B)
- › Select two favorites

- › Wählen Sie einen Timer (15/30/45 Minuten)
- › Dimmen & Lichtfarbenwechsel
- › Gruppenauswahl (Gruppe: A, B, A+B)
- › Zwei Favoriten auswählen

- › Choix d'une minuterie (15/30/45 minutes)
- › Dimmable et changement de couleur de lumière
- › Sélection de groupe (groupe : A, B, A+B)
- › Sélection de deux favoris



YOUR TRACK PLUS SYSTEM IN 3 STEPS / IHR TRACK PLUS SYSTEM IN 3 SCHRITTEN / VOTRE SYSTÈME TRACK PLUS EN 3 ÉTAPES

1 STARTER SET / STARTER-SET / KIT DE DÉMARRAGE



2 EXTENSION SET / VERLÄNGERUNGS-SET / KIT DE RALLONGE



Connectors to create lines, wall to ceiling connection, L, T and X connections are included in the kits. / Verbindungsstücke zum Erstellen von Geraden, Wand-Decken-Verbindungen, L-, T- und X-Verbindungen sind in den Kits enthalten. / Des connecteurs pour créer des lignes, des connexions mur-plafond, des connexions L, T et X sont inclus dans les kits.

3 LIGHTING / BELEUCHTUNG / ECLAIRAGE



Choose among the 5 lighting modules to create your own atmosphere. Each CCT light can bring high lumen output, around 900 lumen.

Wählen Sie zwischen den 5 Beleuchtungsmodulen, um Ihre eigene Atmosphäre zu schaffen. Jedes CCT-Licht hat eine hohe Lichtausbeute von etwa 900 lm. Jedes CCT-Licht kann einen hohen Lumen-Output von etwa 900 Lumen liefern.

Choisissez parmi les 5 modules d'éclairage pour créer votre propre atmosphère. Chaque lumière CCT peut fournir un rendement lumineux élevé, d'environ 900 lumens.

1 TPLUS STARTER SET

The starter set contains:

- > 1x remote control
- > 1x track 0.95m
- > 1x driver (48W) + connector for deposed setup
- > 1x ceiling to wall connector
- > 2x covers
- > 2x end cap

Das Starter-Set enthält:

- > 1x Fernbedienung
- > 1x Schiene 0,95m
- > 1x Treiber (48W) + Verbinder für versetztes Netzteil
- > 1x Wand-Decken-Verbinder (Kreuz)
- > 2x Abdeckungen
- > 2x Endkappe

Le kit de démarrage comprend :

- > 1x télécommande
- > 1x rail de 0,95m
- > 1x driver (48W) + connecteur pour installation déportée
- > 1x connecteur plafond-mur
- > 2x caches
- > 2x embout



901753

2 TPLUS EXTENSION

The Extension set contains:

- > 1x rail 0.95m
- > 2x connectors (straight)
- > 1x adjustable connector
- > 2x covers
- > 1x end cap

Das Verlängerungs-Set enthält:

- > 1x Schiene 0,95m
- > 2x Verbinder (Gerade)
- > 1x verstellbarer Verbinder
- > 2x Abdeckungen
- > 1x Endkappe

Le kit de rallonge comprend :

- > 1x rail de 0,95m
- > 2x connecteurs (droit)
- > 1x connecteur réglable
- > 2x caches
- > 1x embout



901669

901753 TPLUS STARTER SET

accessory; plastic, black
Zubehör; Kunststoff, schwarz
Accessoires; plastique, noir

L 950, B 30, H 6

901669 TPLUS EXTENSION

accessory; plastic, black
Zubehör; Kunststoff, schwarz
Accessoires; plastique, noir

L 950, B 30, H 6



9 008606 329625



L 950



9 008606 323159



L 950





901683 TPLUS SLIM SPOT

spot; plastic, black
Spot; Kunststoff, schwarz
spot; plastique, noir

L 120, H 140, Ø 55



901684 TPLUS WIDE SPOT

spot; plastic, black
Spot; Kunststoff, schwarz
spot; plastique, noir

L 120, H 40, Ø 85



901685 TPLUS FLAT LIGHT

ceiling light; plastic, black
Deckenleuchte; Kunststoff, schwarz
plafonnier; plastique, noir

L 300, B 30, H 12

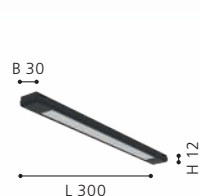



901687



901686



901687 TPLUS PENDANT

spot; plastic, black
Spot; Kunststoff, schwarz
spot; plastique, noir

L 120, H 1100, Ø 55

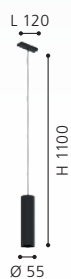

901686 TPLUS 6 LENS SPOT

spot; plastic, black
Spot; Kunststoff, schwarz
spot; plastique, noir

L 180, B 40, H 30

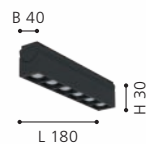

1 TPLUS STARTER SET

The starter set contains:

- > 1x remote control
- > 1x track 0.95m
- > 1x driver (48W) + connector for deported setup
- > 1x ceiling to wall connector
- > 2x covers
- > 2x end cap

Das Starter-Set enthält:

- > 1x Fernbedienung
- > 1x Schiene 0,95m
- > 1x Treiber (48W) + Verbinder für versetztes Netzteil
- > 1x Wand-Decken-Verbinder (Kreuz)
- > 2x Abdeckungen
- > 2x Endkappe

Le kit de démarrage comprend :

- > 1x télécommande
- > 1x rail de 0,95m
- > 1x driver (48W) + connecteur pour installation déportée
- > 1x connecteur plafond-mur
- > 2x caches
- > 2x embout



901754

2 TPLUS EXTENSION

The Extension set contains:

- > 1x rail 0.95m
- > 2x connectors (straight)
- > 1x adjustable connector
- > 2x covers
- > 1x end cap

Das Verlängerungs-Set enthält:

- > 1x Schiene 0,95m
- > 2x Verbinder (Gerade)
- > 1x verstellbarer Verbinder
- > 2x Abdeckungen
- > 1x Endkappe

Le kit de rallonge comprend :

- > 1x rail de 0,95m
- > 2x connecteurs (droit)
- > 1x connecteur réglable
- > 2x caches
- > 1x embout



901691

901754 TPLUS STARTER SET

accessory; plastic, white
Zubehör; Kunststoff, weiss
Accessoires; plastique, blanc

L 950, B 30, H 6

901691 TPLUS EXTENSION

accessory; plastic, white
Zubehör; Kunststoff, weiss
Accessoires; plastique, blanc

L 950, B 30, H 6



9 008606 329632



L 950



9 008606 323319



L 950





901706



901707



901708



901706 TPLUS SLIM SPOT

spot; plastic, white
Spot; Kunststoff, weiss
spot; plastique, blanc

L 120, H 140, Ø 55



9 008606 323234



901707 TPLUS WIDE SPOT

spot; plastic, white
Spot; Kunststoff, weiss
spot; plastique, blanc

L 120, H 40, Ø 85



9 008606 323241



901708 TPLUS FLAT LIGHT

ceiling light; plastic, white
Deckenleuchte; Kunststoff, weiss
plafonnier; plastique, blanc

L 300, B 30, H 12



9 008606 323258

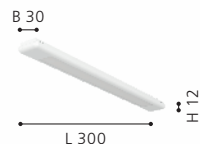



901711



901709



901711 TPLUS PENDANT

spot; plastic, white
Spot; Kunststoff, weiss
spot; plastique, blanc

L 120, H 1100, Ø 55



6W



900lm



Remote



9 008606 323272

901709 TPLUS 6 LENS SPOT

spot; plastic, white
Spot; Kunststoff, weiss
spot; plastique, blanc

L 180, B 40, H 30



6W



900lm



Remote

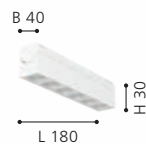

9 008606 323265



LED PANEL LUMINAIRES

ADVANTAGES

- > SURFACE LIGHT - CLEAR LINES AND FLAT DESIGN
 - > ENERGY-EFFICIENT AND COST-SAVING THANKS TO LED TECHNOLOGY
 - > MULTIPLE APPLICATION POSSIBILITIES: LIVING ROOM, BEDROOM, HOME OFFICE, KITCHEN, CELLAR, WORK SURFACES, HALLWAY AND MUCH MORE.
 - > MODERN TECHNOLOGY
 - > FUNCTIONS FROM ON/OFF TO RGBW
 - > DIFFERENT MATERIALS - METAL, PLASTIC
-

VORTEILE

- > FLÄCHENLICHT - KLARE LINIEN UND FLACHE BAUFORM
 - > ENERGIEEFFIZIENT UND KOSTENSPAREND DURCH LED-TECHNOLOGIE
 - > DIVERSE EINSATZMÖGLICHKEITEN: WOHNZIMMER, SCHLAFZIMMER, HOMEOFFICE, KÜCHE, KELLER, ARBEITSFLÄCHEN, FLUR, UVM.
 - > MODERNE TECHNIK
 - > FUNKTIONEN VON ON/OFF BIS RGBW
 - > VERSCHIEDENE MATERIALIEN - METALL, KUNSTSTOFF
-

AVANTAGES

- > ÉCLAIRAGE DE SURFACE - LIGNES CLAIRES ET DESIGN PLAT
- > EFFICACITÉ ÉNERGÉTIQUE ET ÉCONOMIE DE COÛTS GRÂCE À LA TECHNOLOGIE LED
- > MULTIPLES POSSIBILITÉS D'UTILISATION : SALON, CHAMBRE À COUCHER, BUREAU À DOMICILE, CUISINE, CAVE, PLANS DE TRAVAIL, COULOIR ET BIEN PLUS ENCORE.
- > TECHNOLOGIE MODERNE
- > FONCTIONS DE ON/OFF À RGBW
- > DIFFÉRENTS MATÉRIAUX - MÉTAL, PLASTIQUE



LED PANEL FUNCTION

Item no. Art.-Nr. N° d'art.	Series name Seriename Nom de la série	Dimensions Größe Dimensions	Page Seite Page	warm white warmweiß blanc chaud	neutral white neutralweiß blanc neutre	tunable white tunable white tunable white	RGB RGB RGB
901438	ROVITO	H 30, Ø 300	136			•	
901439	ROVITO	H 30, Ø 390	136			•	
901441	ROVITO	H 32, Ø 500	136			•	
901442	ROVITO	L 290, B 290, H 30	137			•	
901443	ROVITO	L 390, B 390, H 30	137			•	
901444	ROVITO	L 500, B 500, H 32	138			•	
901445	ROVITO	L 570, B 300, H 30	138			•	
901452	ROVITO	L 500, B 500, H 32	139			•	
901453	ROVITO	L 570, B 300, H 30	139			•	
901446	ROVITO	H 30, Ø 300	140			•	
901447	ROVITO	H 30, Ø 390	140			•	
901448	ROVITO	H 32, Ø 500	140			•	
901449	ROVITO	L 290, B 290, H 30	141			•	
901451	ROVITO	L 390, B 390, H 30	141			•	
901454	ROVITO-R	H 30, Ø 390	142			•	
901455	ROVITO-R	H 32, Ø 500	142			•	
901456	ROVITO-R	L 390, B 390, H 30	143			•	
901457	ROVITO-R	L 500, B 500, H 32	143			•	
901458	ROVITO-R	H 30, Ø 390	144			•	
901459	ROVITO-R	H 32, Ø 500	144			•	
901461	ROVITO-R	L 390, B 390, H 30	145			•	
901462	ROVITO-R	L 500, B 500, H 32	145			•	
99728	URTEBIETA	L 595, B 595, H 50	146		•		
99729	URTEBIETA	L 1195, B 295, H 50	146		•		
32812	SALOBRENA 1	L 300, B 300, H 50	148		•		
98129	SALOBRENA 1	L 450, B 450, H 50	148		•		
32811	SALOBRENA 1	L 1200, B 300, H 50	149		•		
32813	SALOBRENA 1	L 595, B 595, H 50	149		•		
98025	SALOBRENA 1	L 1195, B 100, H 45	149		•		
900818	SALOBRENA 1	L 450, B 450, H 50	150		•		
900817	SALOBRENA 1	L 300, B 300, H 50	150		•		
900819	SALOBRENA 1	L 595, B 595, H 50	151		•		
900821	SALOBRENA 1	L 1200, B 300, H 50	151		•		
900822	SALOBRENA 1	L 1195, B 100, H 45	151		•		
98201	SALOBRENA-A	L 300, B 300, H 50	152			•	
98203	SALOBRENA-A	L 600, B 600, H 50	152			•	
98297	SALOBRENA-A	L 450, B 450, H 50	152			•	
98205	SALOBRENA-A	L 1200, B 300, H 50	153			•	
98206	SALOBRENA-A	L 1195, B 100, H 50	153			•	
98418	SALOBRENA-M	L 595, B 595, H 50	154				
98419	SALOBRENA-M	L 1195, B 295, H 50	154				
98766	SALOBRENA-B	L 595, B 595, H 55	155			•	•
98767	SALOBRENA-B	L 1200, B 300, H 55	155			•	•
33107	SALOBRENA-RGBW	L 450, B 450, H 11	156			•	•
33108	SALOBRENA-RGBW	L 600, B 300, H 11	156			•	•

LED PANEL FUNCTION

Item no. Art.-Nr. N° d'art.	Series name Seriennamen Nom de la série	Dimensions Größe Dimensions	Page Seite Page	warm white warmweiß blanc chaud	neutral white neutralweiß blanc neutre	tunable white tunable white tunable white	RGB RGB RGB
900937	RABASSA	L 595, B 595, H 27	158		•		
900939	RABASSA	L 1195, B 295, H 27	158		•		
900938	RABASSA	L 620, B 620, H 27	158	•	•		•
96152	SALOBRENA 1	L 300, B 300, H 11	160	•	•		•
96153	SALOBRENA 1	L 595, B 595, H 11	160	•	•		•
96154	SALOBRENA 1	L 620, B 620, H 11	160	•	•		•
96151	SALOBRENA 1	L 1200, B 300, H 11	161		•		
97502	SARSINA	H 50, Ø 450	164		•		
97503	SARSINA	H 50, Ø 600	164		•		
97501	SARSINA	H 50, Ø 300	164		•		
98208	SARSINA-A	H 50, Ø 450	165			•	
98209	SARSINA-A	H 50, Ø 600	165			•	
98207	SARSINA-A	H 50, Ø 300	165			•	
99833	TURCONA-CCT	L 287, B 287, H 62	168			•	
99834	TURCONA-CCT	L 437, B 437, H 70	169			•	
99835	TURCONA-CCT	L 587, B 587, H 70	169			•	
99836	TURCONA-CCT	L 1187, B 287, H 70	169			•	
900568	TRUPIANA	L 437, B 437, H 62	170			•	•
900569	TRUPIANA	L 587, B 587, H 62	170			•	•
98901	TURCONA	L 300, B 300, H 60	172		•		
98902	TURCONA	L 450, B 450, H 60	172		•		
98903	TURCONA	L 595, B 595, H 60	172		•		
98904	TURCONA	L 1200, B 300, H 60	173		•		
98905	TURCONA	L 1200, B 100, H 60	173		•		
900961	ALBARCA	L 588, B 588, H 69	174			•	•
900959	ALBARCA	L 438, B 438, H 69	174			•	•
900571	BORDONARA	L 450, B 450	178			•	•
900572	BORDONARA	L 595, B 595	178			•	•
900573	BORDONARA	L 1195, B 295	178			•	•
900558	MARMORATA	H 70, Ø 450	180	•			
900559	MARMORATA	L 445, B 445	180	•			
900561	MARMORATA	L 595, B 295	180	•			
901191	BALAZOTE	H 50, Ø 380	182			•	•
99038	SAVATARILA	L 450, B 450, H 60	183		•		
99039	SAVATARILA	L 595, B 595, H 60	183		•		
901192	BALAZOTE	L 360, B 360, H 50	183			•	•
99842	LAZARAS	L 450, B 450, H 60	185	•	•		•
99841	LAZARAS	H 55, Ø 450	185	•	•		•



LED PANEL LUMINAIRES

WITH FRAME

ADVANTAGES

- > SURFACE LIGHT WITH SHADOWLESS LIGHTING
 - > ULTRA-FLAT DESIGN
 - > HOMOGENEOUS SURFACE LIGHTING
 - > SIMPLE INSTALLATION
 - > ELEGANT SUSPENSION FRAME INCLUDED
 - > ALSO FOR FLUSH MOUNTING SUITABLE
-

VORTEILE

- > FLÄCHIGES LICHT MIT SCHATTENFREIER AUSLEUCHTUNG
 - > ULTRAFLACHES DESIGN
 - > HOMOGENE FLÄCHENAUSLEUCHTUNG
 - > EINFACHE MONTAGE
 - > INKL. ELEGANTEM SCHWEBERAHMEN
 - > AUCH FÜR FLÄCHENBÜNDIGEN EINBAU GEEIGNET
-

AVANTAGES

- > ÉCLAIRAGE ÉTALÉ AVEC ÉCLAIREMENT
- > SANS OMBRE
- > DESIGN ULTRA PLAT
- > ÉCLAIRAGE DE SURFACE HOMOGENÈ
- > MONTAGE SIMPLE
- > BÂTI FLOTTANT ÉLÉGANT INCLUS ADAPTÉ AU MONTAGE ENCASTRÉ



OVERVIEW

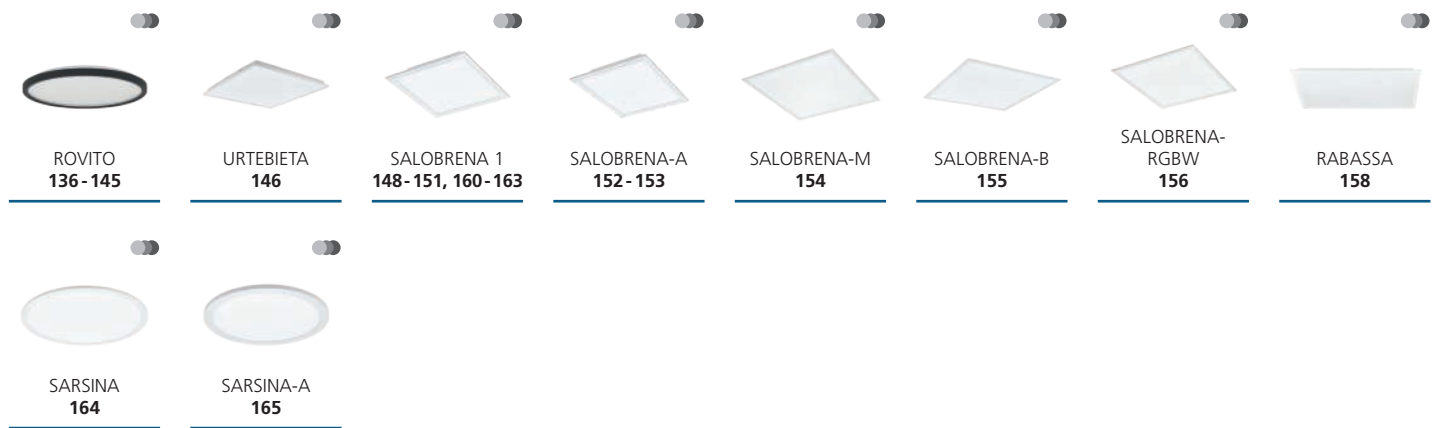

ACCESSORIES INCLUDED

All luminaires including Suspension frame
 Alle Leuchten inklusive Schweberahmen
 Tous les luminaires inclus bâti flottant

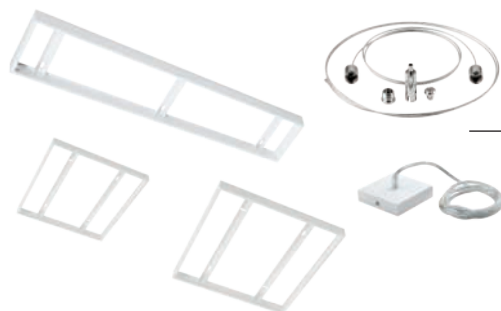

ACCESSORIES OPTIONAL

PAGE / SEITE / PAGE **162-163**



This product is available in different colors and shapes./ Dieser Artikel ist in unterschiedlichen Farben und Formen verfügbar./
 Cet article est disponible en différentes couleurs et formes.



901438



IP44



901439



IP44



901441



IP44

901438 ROVITO

ceiling light; plastic, black / plastic, white
Deckenleuchte; Kunststoff, schwarz / Kunststoff, weiss
plafonnier; plastique, noir / plastique, blanc

H 30, Ø 300



14,4W 1800lm IP44

901439 ROVITO

ceiling light; plastic, black / plastic, white
Deckenleuchte; Kunststoff, schwarz / Kunststoff, weiss
plafonnier; plastique, noir / plastique, blanc

H 30, Ø 390

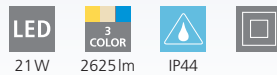

21W 2625lm IP44

901441 ROVITO

ceiling light; plastic, black / plastic, white
Deckenleuchte; Kunststoff, schwarz / Kunststoff, weiss
plafonnier; plastique, noir / plastique, blanc

H 32, Ø 500



28,8W 3600lm IP44



9 008606 329847

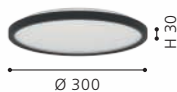

9 008606 329854



9 008606 329861





901442



IP44



ROVITO

The light colour of these lights can be controlled in three steps via dip switch.

Die Lichtfarbe diese Leuchten können mittels Dip-Schalter in drei Stufen gesteuert werden.

La couleur de la lumière de ces lampes peut être contrôlée en trois étapes à l'aide d'un interrupteur DIP.

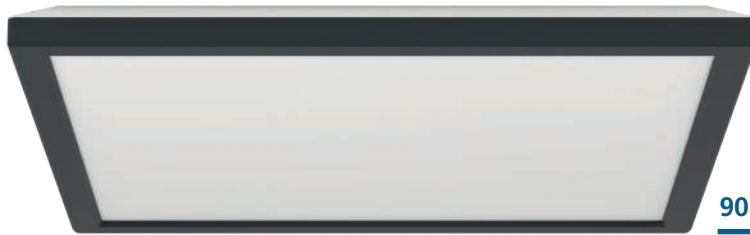

901443



IP44

901442 ROVITO

ceiling light; plastic, black / plastic, white
Deckenleuchte; Kunststoff, schwarz / Kunststoff, weiss
plafonnier; plastique, noir / plastique, blanc

L 290, B 290, H 30



14,4W



2000lm



IP44



9 008606 329878



901443 ROVITO

ceiling light; plastic, black / plastic, white
Deckenleuchte; Kunststoff, schwarz / Kunststoff, weiss
plafonnier; plastique, noir / plastique, blanc

L 390, B 390, H 30



21W



3000lm



IP44



9 008606 329885

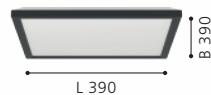

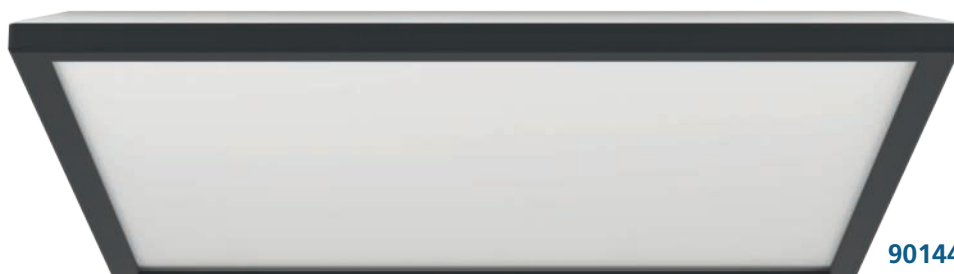

901444



IP44

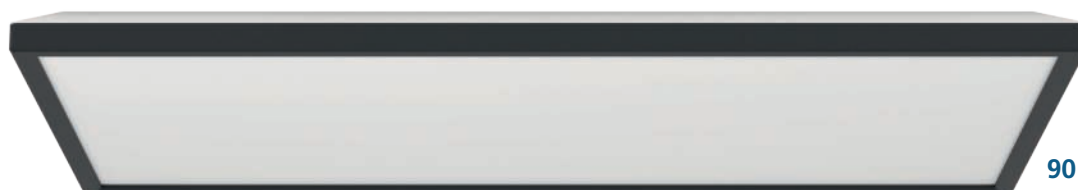

901445



IP44

901444 ROVITO

ceiling light; plastic, black / plastic, white
Deckenleuchte; Kunststoff, schwarz / Kunststoff, weiss
plafonnier; plastique, noir / plastique, blanc

L 500, B 500, H 32

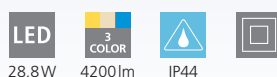

28,8W 4200lm IP44



9 008606 329892



L 500

B 500

901445 ROVITO

ceiling light; plastic, black / plastic, white
Deckenleuchte; Kunststoff, schwarz / Kunststoff, weiss
plafonnier; plastique, noir / plastique, blanc

L 570, B 300, H 30

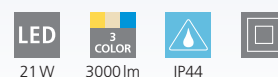

21W 3000lm IP44



9 008606 329908



L 570

B 300

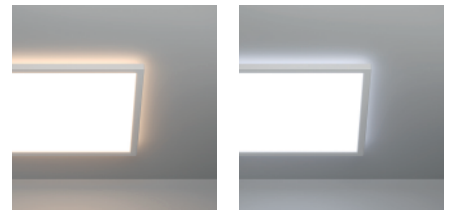

ROVITO

The light colour of these lights can be controlled in three steps via dip switch.

Die Lichtfarbe diese Leuchten können mittels Dip-Schalter in drei Stufen gesteuert werden.

La couleur de la lumière de ces lampes peut être contrôlée en trois étapes à l'aide d'un interrupteur DIP.

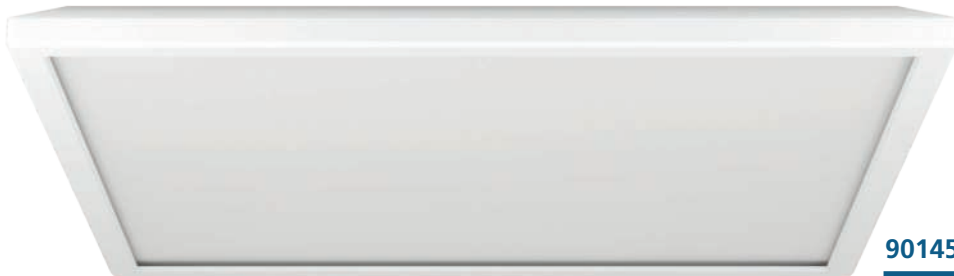

901452



IP44



901453



IP44

901452 ROVITO

ceiling light; plastic, white / plastic, white
Deckenleuchte; Kunststoff, weiss / Kunststoff, weiss
plafonnier; plastique, blanc / plastique, blanc

L 500, B 500, H 32



28,8W



4200lm



IP44



9 008606 329960



901453 ROVITO

ceiling light; plastic, white / plastic, white
Deckenleuchte; Kunststoff, weiss / Kunststoff, weiss
plafonnier; plastique, blanc / plastique, blanc

L 570, B 300, H 30



21W



3000lm



IP44



9 008606 329977



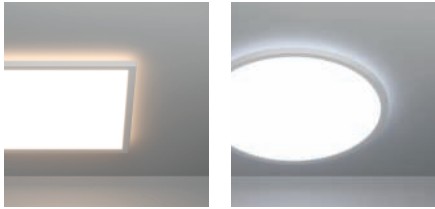

ROVITO

The light colour of these lights can be controlled in three steps via dip switch.

Die Lichtfarbe diese Leuchten können mittels Dip-Schalter in drei Stufen gesteuert werden.

La couleur de la lumière de ces lampes peut être contrôlée en trois étapes à l'aide d'un interrupteur DIP.



901446



IP44



901447



IP44



901448



IP44

901446 ROVITO

ceiling light; plastic, white / plastic, white
Deckenleuchte; Kunststoff, weiss / Kunststoff, weiss
plafonnier; plastique, blanc / plastique, blanc

H 30, Ø 300

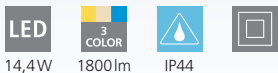

14,4W 1800lm IP44



9 008606 329915



901447 ROVITO

ceiling light; plastic, white / plastic, white
Deckenleuchte; Kunststoff, weiss / Kunststoff, weiss
plafonnier; plastique, blanc / plastique, blanc

H 30, Ø 390



21W 2625lm IP44



9 008606 329922



901448 ROVITO

ceiling light; plastic, white / plastic, white
Deckenleuchte; Kunststoff, weiss / Kunststoff, weiss
plafonnier; plastique, blanc / plastique, blanc

H 32, Ø 500

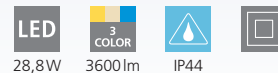

28,8W 3600lm IP44



9 008606 329939

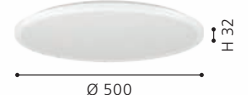



901449



IP44



901451



IP44

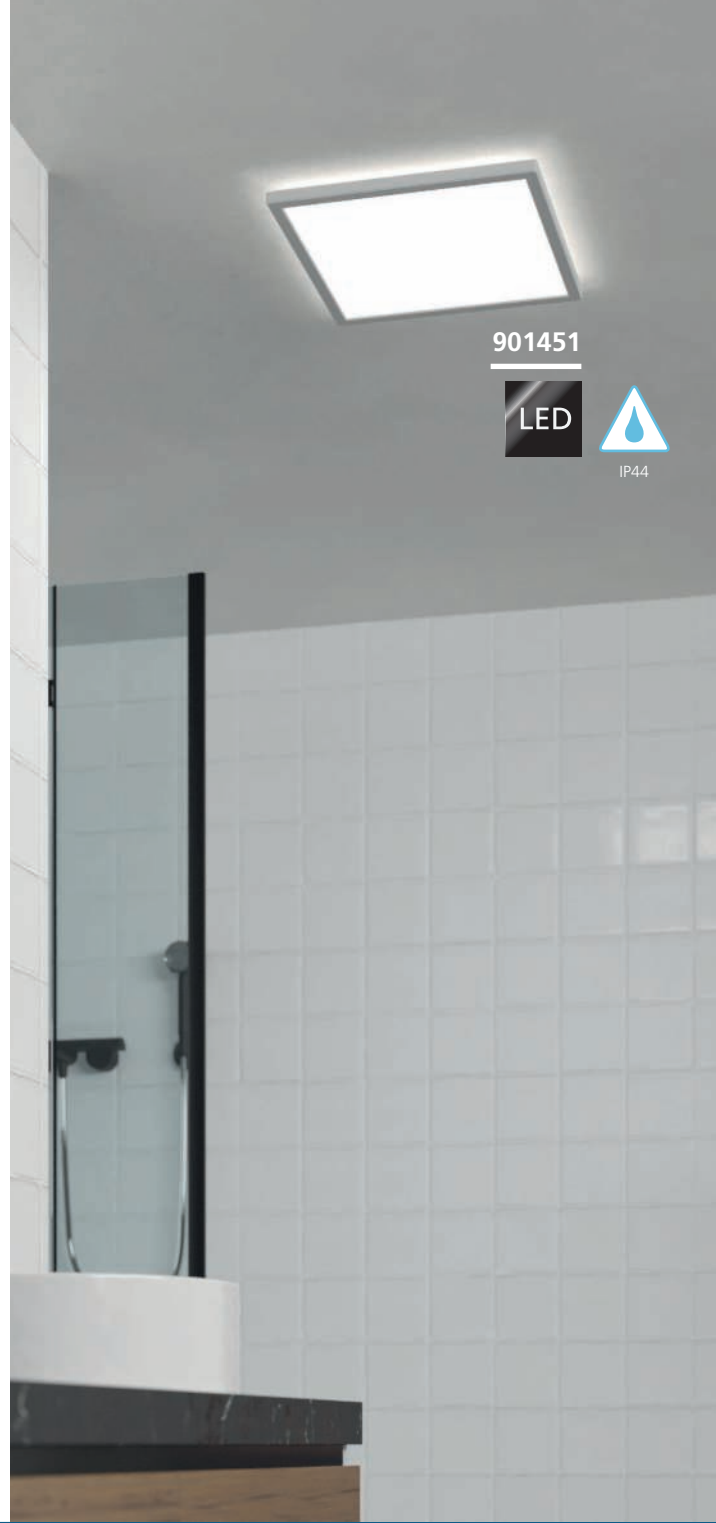

901451



IP44

901449 ROVITO

ceiling light; plastic, white / plastic, white
Deckenleuchte; Kunststoff, weiss / Kunststoff, weiss
plafonnier; plastique, blanc / plastique, blanc

L 290, B 290, H 30



14,4W



2000lm



IP44



901451 ROVITO

ceiling light; plastic, white / plastic, white
Deckenleuchte; Kunststoff, weiss / Kunststoff, weiss
plafonnier; plastique, blanc / plastique, blanc

L 390, B 390, H 30



21W



3000lm



IP44



9 008606 329946



L 290



9 008606 329953



L 390



901454



IP44



REMOTE+

Our new 2.4 GHz REMOTE+ makes it easier than ever to control your luminaires. With its user-friendly design and simple control, you can easily adjust your luminaires to create the perfect ambiance for any occasion:

- > Stepless Dimming
- > Quick Pairing
- > Timer Function
- > Stepless Tunable White
- > Memory Effect
- > Control up to 10 REMOTE+ luminaires

Unsere neue 2,4-GHz REMOTE+ macht die Steuerung Ihrer Leuchten so einfach wie nie zuvor. Mit ihrem benutzerfreundlichen Design und der einfachen Steuerung können Sie Ihre Leuchten ganz einfach einstellen, um das perfekte Ambiente für jede Gelegenheit zu schaffen:

- > Stufenloses Dimmen
- > Schnelle Kopplung
- > Timer-Funktion
- > Stufenlos einstellbares Weiß
- > Memory-Effekt
- > Steuerung von bis zu 10 REMOTE+-Leuchten

Notre nouvelle REMOTE+ 2,4 GHz facilite plus que jamais le contrôle de vos lumières. Grâce à sa conception conviviale et à sa commande simple, vous pouvez facilement régler votre luminaire pour créer l'ambiance parfaite en toute occasion:

- > Gradation progressive
- > appairage rapide
- > Fonction de minuterie
- > Blanc réglable en continu
- > Effet de mémoire
- > Contrôle jusqu'à 10 luminaires REMOTE



901455



IP44



901454 ROVITO-R

ceiling light; plastic, black / plastic, white
Deckenleuchte; Kunststoff, schwarz / Kunststoff, weiss
plafonnier; plastique, noir / plastique, blanc

H 30, Ø 390



21W



2625lm



Remote



IP44



9 008606 329984



901455 ROVITO-R

ceiling light; plastic, black / plastic, white
Deckenleuchte; Kunststoff, schwarz / Kunststoff, weiss
plafonnier; plastique, noir / plastique, blanc

H 32, Ø 500



28,8W



3600lm



Remote



IP44



9 008606 329991

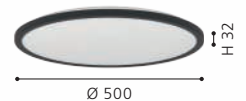



901456



IP44

incl./inkl./inclus



ROVITO-R

These lights have individually controllable light settings on the inside and outside of the frame.

Diese Leuchten verfügen über individuell steuerbare Lichteinstellungen der Rahmen innen und außen.

Ces lumières ont des paramètres d'éclairage contrôlables individuellement du cadre.

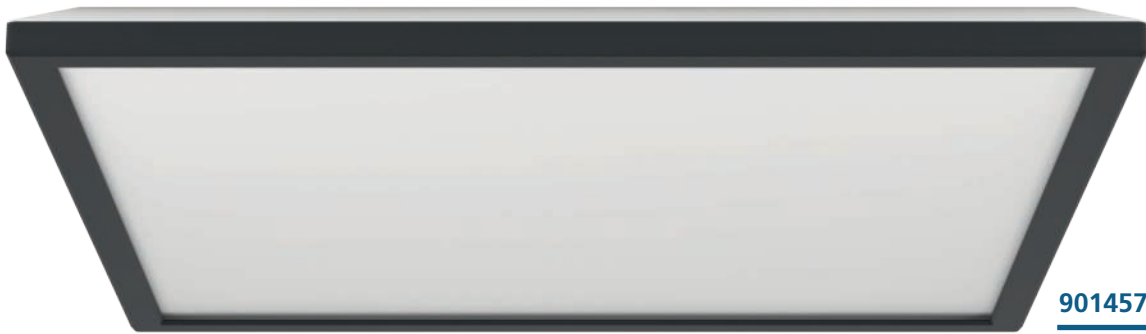

901457



IP44

incl./inkl./inclus



901456 ROVITO-R

ceiling light; plastic, black / plastic, white
Deckenleuchte; Kunststoff, schwarz / Kunststoff, weiss
plafonnier; plastique, noir / plastique, blanc

L 390, B 390, H 30



21 W



3000lm



Remote



IP44



9 008606 330003



L 390

901457 ROVITO-R

ceiling light; plastic, black / plastic, white
Deckenleuchte; Kunststoff, schwarz / Kunststoff, weiss
plafonnier; plastique, noir / plastique, blanc

L 500, B 500, H 32



28,8 W



4200lm



Remote



IP44



9 008606 330010

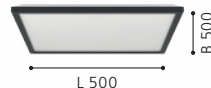

L 500



901458



IP44

incl./inkl./inclus



901459



IP44

incl./inkl./inclus



901458 ROVITO-R

ceiling light; plastic, white / plastic, white
 Deckenleuchte; Kunststoff, weiss / Kunststoff, weiss
 plafonnier; plastique, blanc / plastique, blanc

H 30, Ø 390



21W



2625lm



Remote



IP44



9 008606 330027



901459 ROVITO-R

ceiling light; plastic, white / plastic, white
 Deckenleuchte; Kunststoff, weiss / Kunststoff, weiss
 plafonnier; plastique, blanc / plastique, blanc

H 32, Ø 500



28,8W



3600lm



Remote



IP44



9 008606 330034

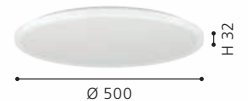

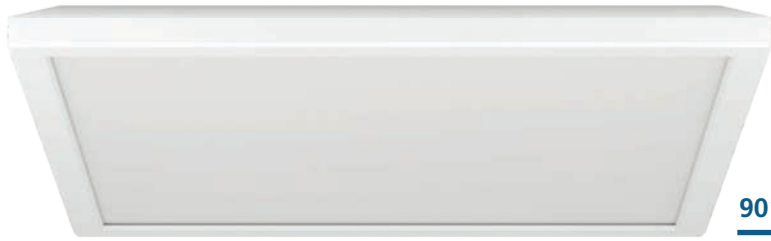

901461



incl./inkl./inclus

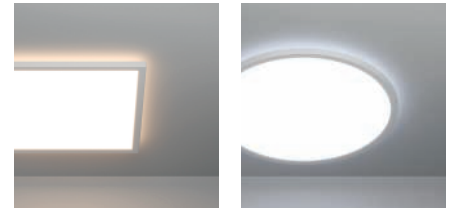

ROVITO-R

These lights have individually controllable light settings on the inside and outside of the frame.

Diese Leuchten verfügen über individuell steuerbare Lichteinstellungen der Rahmen innen und außen.

Ces lumières ont des paramètres d'éclairage contrôlables individuellement du cadre.



901462



incl./inkl./inclus



901461 ROVITO-R

ceiling light; plastic, white / plastic, white
Deckenleuchte; Kunststoff, weiss / Kunststoff, weiss
plafonnier; plastique, blanc / plastique, blanc

L 390, B 390, H 30



21 W



3000lm



Remote



IP44



9 008606 330041

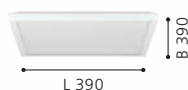

901462 ROVITO-R

ceiling light; plastic, white / plastic, white
Deckenleuchte; Kunststoff, weiss / Kunststoff, weiss
plafonnier; plastique, blanc / plastique, blanc

L 500, B 500, H 32



28,8 W



4200lm



Remote



IP44



9 008606 330058





99728



99729



99729

These luminaires are very suitable for the home office due to their reduced glare.

Diese Leuchten sind aufgrund ihres reduzierten Blendeffekts sehr gut für das Homeoffice geeignet.

These luminaires are very suitable for the home office due to their reduced glare.

99728 URTEBIETA

ceiling light; steel, white / plastic, white
Deckenleuchte; Stahl, weiss / Kunststoff, weiss
plafonnier; acier, blanc / plastique, blanc

L 595, B 595, H 50



32W 4700lm

99729 URTEBIETA

ceiling light; steel, white / plastic, white
Deckenleuchte; Stahl, weiss / Kunststoff, weiss
plafonnier; acier, blanc / plastique, blanc

L 1195, B 295, H 50



32W 4700lm



9 002759 997281

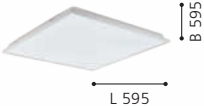

9 002759 997298





99729

LED



32813

LED



32812

LED



98129

LED

32812 SALOBRENA 1

ceiling light; aluminium, steel, white / plastic, white
Deckenleuchte; Alu, Stahl, weiss / Kunststoff, weiss
plafonnier; aluminium, acier, blanc / plastique, blanc

L 300, B 300, H 50



14W



2000lm



98129 SALOBRENA 1

ceiling light; aluminium, white / plastic, white
Deckenleuchte; Alu, weiss / Kunststoff, weiss
plafonnier; aluminium, blanc / plastique, blanc

L 450, B 450, H 50



21,5W



3000lm



9 002759 328122

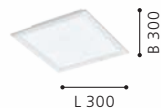

9 002759 981297

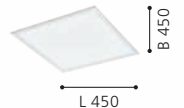



32813

LED



32811

LED



98025

LED

32813 SALOBRENA 1

ceiling light; aluminium, steel, white / plastic, white
Deckenleuchte; Alu, Stahl, weiss / Kunststoff, weiss
plafonnier; aluminium, acier, blanc / plastique, blanc

L 595, B 595, H 50



33W 4700lm

32811 SALOBRENA 1

ceiling light; aluminium, steel, white / plastic, white
Deckenleuchte; Alu, Stahl, weiss / Kunststoff, weiss
plafonnier; aluminium, acier, blanc / plastique, blanc

L 1200, B 300, H 50



33W 4700lm

98025 SALOBRENA 1

ceiling light; aluminium, white / plastic, white
Deckenleuchte; Alu, weiss / Kunststoff, weiss
plafonnier; aluminium, blanc / plastique, blanc

L 1195, B 100, H 45



38W 4700lm



9 002759 328139

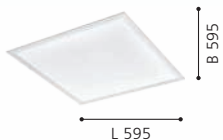

L 595



9 002759 328115

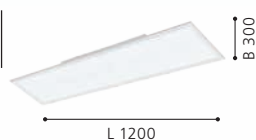

L 1200



9 002759 980252



L 1195



900817



900817



900818



900817 SALOBRENA 1

ceiling light; aluminium, steel, black / plastic, white
 Deckenleuchte; Alu, Stahl, schwarz / Kunststoff, weiss
 plafonnier; aluminium, acier, noir / plastique, blanc

L 300, B 300, H 50



14W 2000lm

900818 SALOBRENA 1

ceiling light; aluminium, black / plastic, white
 Deckenleuchte; Alu, schwarz / Kunststoff, weiss
 plafonnier; aluminium, noir / plastique, blanc

L 450, B 450, H 50



21,5W 3000lm



9 008606 259854



9 008606 259861





900819



900821



900822



900819 SALOBRENA 1

ceiling light; aluminium, steel, black / plastic, white
Deckenleuchte; Alu, Stahl, schwarz / Kunststoff, weiss
plafonnier; aluminium, acier, noir / plastique, blanc

L 595, B 595, H 50



33W 4700lm

900821 SALOBRENA 1

ceiling light; aluminium, steel, black / plastic, white
Deckenleuchte; Alu, Stahl, schwarz / Kunststoff, weiss
plafonnier; aluminium, acier, noir / plastique, blanc

L 1200, B 300, H 50



33W 4700lm

900822 SALOBRENA 1

ceiling light; aluminium, black / plastic, white
Deckenleuchte; Alu, schwarz / Kunststoff, weiss
plafonnier; aluminium, noir / plastique, blanc

L 1195, B 100, H 45



38W 4700lm



9 008606 259878



L 595

B 595



9 008606 259885

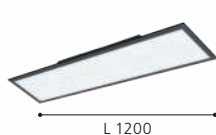

L 1200

B 300



9 008606 259892



L 1195

B 100



98201

LED



incl./inkl./inclus

98297

LED



incl./inkl./inclus

98203

LED



incl./inkl./inclus

98201 SALOBRENA-A

ceiling light; aluminium, white / plastic, white
Deckenleuchte; Alu, weiss / Kunststoff, weiss
plafonnier; aluminium, blanc / plastique, blanc

L 300, B 300, H 50



98297 SALOBRENA-A

ceiling light; aluminium, white / plastic, white
Deckenleuchte; Alu, weiss / Kunststoff, weiss
plafonnier; aluminium, blanc / plastique, blanc

L 450, B 450, H 50



98203 SALOBRENA-A

ceiling light; aluminium, white / plastic, white
Deckenleuchte; Alu, weiss / Kunststoff, weiss
plafonnier; aluminium, blanc / plastique, blanc

L 600, B 600, H 50



9 002759 982010

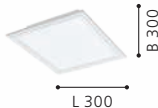

9 002759 982973

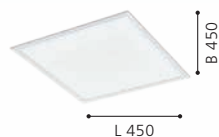

9 002759 982034

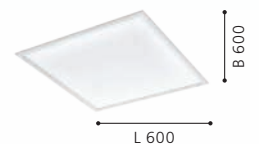



98205



incl./inkl./inclus



98206



incl./inkl./inclus

98205 SALOBRENA-A

ceiling light; aluminium, white / plastic, white
Deckenleuchte; Alu, weiss / Kunststoff, weiss
plafonnier; aluminium, blanc / plastique, blanc

L 1200, B 300, H 50



98206 SALOBRENA-A

ceiling light; aluminium, white / plastic, white
Deckenleuchte; Alu, weiss / Kunststoff, weiss
plafonnier; aluminium, blanc / plastique, blanc

L 1195, B 100, H 50



9 002759 982058

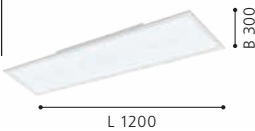

9 002759 982065





98418



12 m
5 sec. - 15 min.

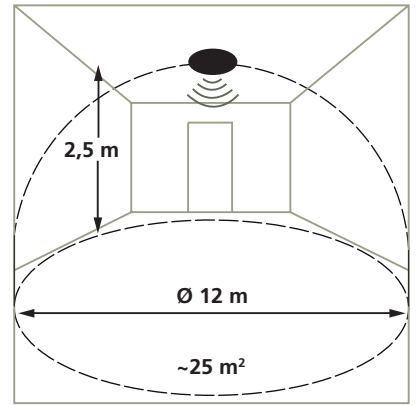

time: 5 sec. - 15 min.

SALOBRENA-M

These luminaires come with an integrated motion sensor. The sensor is not visible.

Diese Leuchten sind mit einem integrierten Bewegungssensor ausgestattet. Der Sensor ist nicht sichtbar.

Ces luminaires viennent avec un capteur de mouvement intégré. Le capteur n'est pas visible.



98419



12 m
5 sec. - 15 min.

98418 SALOBRENA-M

ceiling light; aluminium, white / plastic, white
Deckenleuchte; Alu, weiss / Kunststoff, weiss
plafonnier; aluminium, blanc / plastique, blanc

L 595, B 595, H 50



35W 4600lm



9 002759 984182

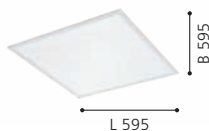

98419 SALOBRENA-M

ceiling light; aluminium, white / plastic, white
Deckenleuchte; Alu, weiss / Kunststoff, weiss
plafonnier; aluminium, blanc / plastique, blanc

L 1195, B 295, H 50



35W 5000lm



9 002759 984199





98766



SALOBRENA-B

The luminaires have an atmospheric indirect RGB light.

Die Leuchten verfügen über ein stimmungsvolles, indirektes RGB-Licht.

Le luminaires dispose d'une lumière d'ambiance indirecte RGB.



98767



98766 SALOBRENA-B

ceiling light; aluminium, steel, white / plastic, white
Deckenleuchte; Alu, Stahl, weiss / Kunststoff, weiss
plafonnier; aluminium, acier, blanc / plastique, blanc

L 595, B 595, H 55



98767 SALOBRENA-B

ceiling light; aluminium, steel, white / plastic, white
Deckenleuchte; Alu, Stahl, weiss / Kunststoff, weiss
plafonnier; aluminium, acier, blanc / plastique, blanc

L 1200, B 300, H 55



9 002759 987664

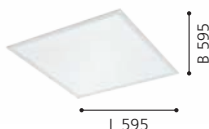

9 002759 987671





33107



incl./inkl./inclus



33108



incl./inkl./inclus

33107 SALOBRENA-RGBW

grid light; aluminium, white / plastic, white
 Rasterleuchte; Alu, weiss / Kunststoff, weiss
 luminaire à grille; aluminium, blanc / plastique, blanc

L 450, B 450, H 11



LED

21W

RGB+NW

2400lm

Remote

33108 SALOBRENA-RGBW

grid light; aluminium, white / plastic, white
 Rasterleuchte; Alu, weiss / Kunststoff, weiss
 luminaire à grille; aluminium, blanc / plastique, blanc

L 600, B 300, H 11



LED

21W

RGB+NW

2400lm

Remote



9 002759 331078

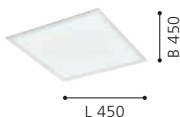

9 002759 331085



SALOBRENA-RGBW

With the remote control (included in delivery) the following features can be adjusted:

Durch die Fernbedienung (im Lieferumfang enthalten) verfügen diese Leuchten über folgende Funktionen:

Les fonctions différentes peuvent être réglées avec une télécommande incluse avec le luminaire:

- > Color change
- > Change to white light
- > Change to RGB
- > Flash (fast color change)
- > Smooth dimming (slow color change)
10%, 25%, 50%, 100%
- > on/off



33107

LED





900937

LED



900938

LED



900939

LED

900937 RABASSA

grid light; aluminium, white / plastic, white
Rasterleuchte; Alu, weiss / Kunststoff, weiss
luminaire à grille; aluminium, blanc / plastique, blanc

L 595, B 595, H 27



34,5W 4900lm

900938 RABASSA

grid light; aluminium, white / plastic, white
Rasterleuchte; Alu, weiss / Kunststoff, weiss
luminaire à grille; aluminium, blanc / plastique, blanc

L 620, B 620, H 27



33W 5200lm

900939 RABASSA

grid light; aluminium, white / plastic, white
Rasterleuchte; Alu, weiss / Kunststoff, weiss
luminaire à grille; aluminium, blanc / plastique, blanc

L 1195, B 295, H 27



34,5W 4900lm



9 008606 277872



L 595

B 595



9 008606 277889



L 620

B 620



9 008606 277896



L 1195

B 295

900937

LED

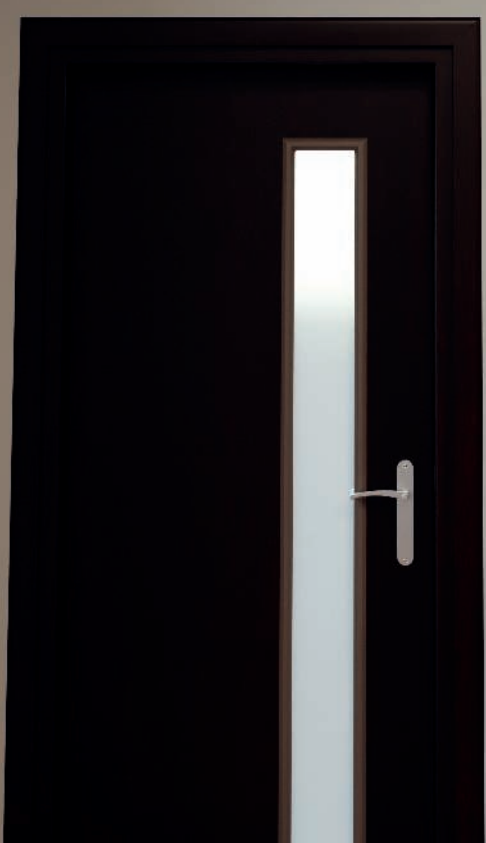

GRID LIGHTS SALOBRENA 1

Slim design with 6 mounting options,
Uniform distribution of light - ideal for
illuminating spaces and surfaces.

Schlanke Bauform mit 6 Montagevarianten,
Homogene Lichtverteilung – ideal zur
Beleuchtung von Räumen und Flächen.

Conception mince avec 6 options de montage,
Distribution uniforme de la lumière - idéal pour
l'illumination des espaces et surfaces.



96152

LED



96153

LED



96154

LED

96152 SALOBRENA 1

grid light; aluminium, white / plastic, white
Rasterleuchte; Alu, weiss / Kunststoff, weiss
luminaire à grille; aluminium, blanc / plastique, blanc

L 300, B 300, H 11



14W 2000lm

96153 SALOBRENA 1

grid light; aluminium, white / plastic, white
Rasterleuchte; Alu, weiss / Kunststoff, weiss
luminaire à grille; aluminium, blanc / plastique, blanc

L 595, B 595, H 11



33W 4700lm

96154 SALOBRENA 1

grid light; aluminium, white / plastic, white
Rasterleuchte; Alu, weiss / Kunststoff, weiss
luminaire à grille; aluminium, blanc / plastique, blanc

L 620, B 620, H 11



35W 4400lm



9 002759 961527

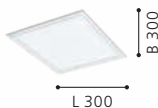

9 002759 961534

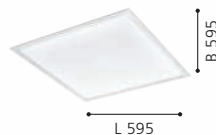

9 002759 961541

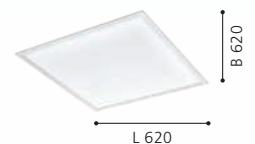



96151

LED

MOUNTING WITH INCLUDED MATERIAL

MONTAGE MIT INKLUDIERTEM MONTAGEMATERIAL

MONTAGE AVEC MATÉRIEL DE MONTAGE INCLUS

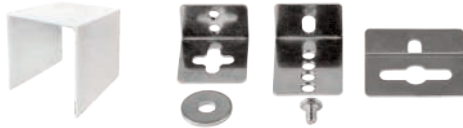

1 GRID LUMINAIRE
RASTERLEUCHTE
LUMINAIRE À GRILLE

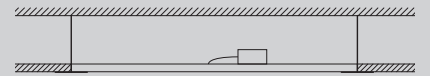

2 RECESSED LUMINAIRE
EINBAULEUCHTE
LUMINAIRE ENCASTRÉE



3 SEMI-RECESSED LUMINAIRE
SEMI-EINBAULEUCHTE
LUMINAIRE SEMI-ENCASTRÉE



4 SURFACE LUMINAIRE
AUFBAULEUCHTE
LUMINAIRE EN SAILLIE

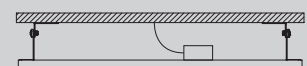

96151 SALOBRENA 1

grid light; aluminium, white / plastic, white
Rasterleuchte; Alu, weiss / Kunststoff, weiss
luminaire à grille; aluminium, blanc / plastique, blanc

L 1200, B 300, H 11

LED

33W

neutral
WHITE

4700lm





61489



61355

61489, 61355

Compatible with: / Kompatibel mit: / Compatible avec :
96151, 96152, 96153, 96154

61358

Compatible with: / Kompatibel mit: / Compatible avec :
96153

61359

Compatible with: / Kompatibel mit: / Compatible avec :
96154

61361

Compatible with: / Kompatibel mit: / Compatible avec :
96151

61489 SALOBRENA 1

accessory; steel, white
Zubehör; Stahl, weiss
Accessoires; acier, blanc

L 95, B 95, H 2000

61355 SALOBRENA 1

accessory; steel, chrome
Zubehör; Stahl, chrom
Accessoires; acier, chrome

L 900

61358 SALOBRENA 1

accessory; steel, white
Zubehör; Stahl, weiss
Accessoires; acier, blanc

L 603, B 603, H 50



9 002759 614898



9 002759 613556



9 002759 613587

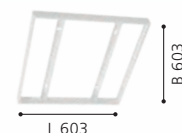

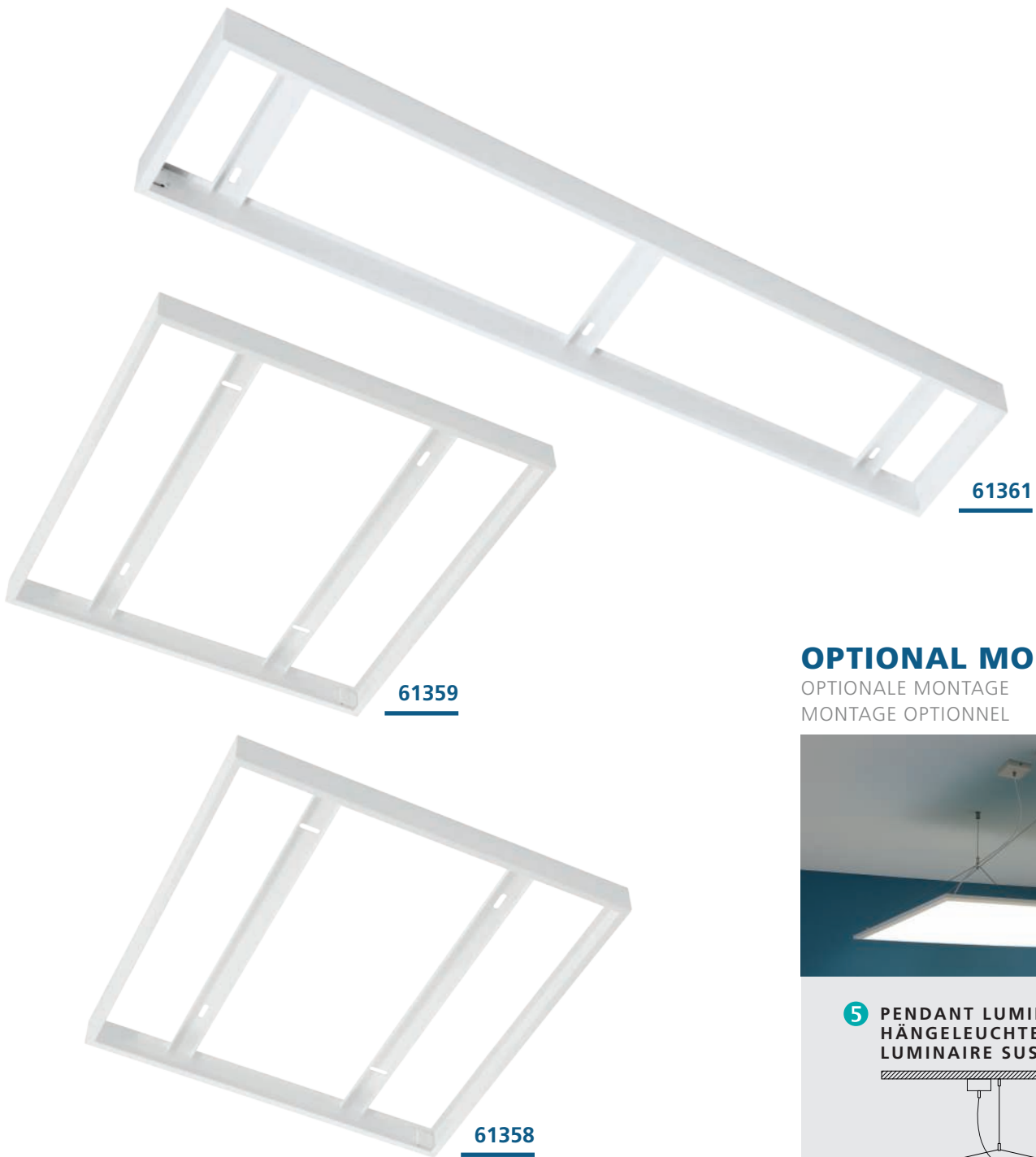

61361

61359

61358

OPTIONAL MOUNTING

OPTIONALE MONTAGE
MONTAGE OPTIONNEL



5 PENDANT LUMINAIRE HÄNGELEUCHT LUMINAIRE SUSPENSION

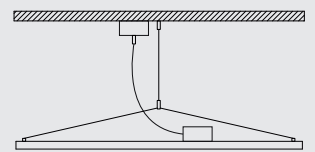

6 FRAME SURFACE LUMINAIRE RAHMEN AUFBAULEUCHT LUMINAIRE EN SAILLIE AVEC BOX

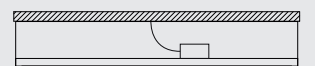

61359 SALOBRENA 1

accessory; steel, white
Zubehör; Stahl, weiss
Accessoires; acier, blanc

L 627, B 628, H 50

61361 SALOBRENA 1

accessory; steel, white
Zubehör; Stahl, weiss
Accessoires; acier, blanc

L 303, B 1205, H 50



9 002759 613594

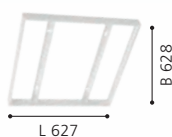

9 002759 613617

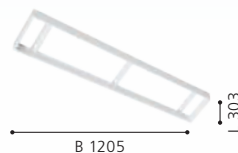



97501



97502



97503



97501 SARSINA

ceiling light; aluminium, white / plastic, white
Deckenleuchte; Alu, weiss / Kunststoff, weiss
plafonnier; aluminium, blanc / plastique, blanc

H 50, Ø 300



17W 2100lm

97502 SARSINA

ceiling light; aluminium, white / plastic, white
Deckenleuchte; Alu, weiss / Kunststoff, weiss
plafonnier; aluminium, blanc / plastique, blanc

H 50, Ø 450



28W 3800lm

97503 SARSINA

ceiling light; aluminium, white / plastic, white
Deckenleuchte; Alu, weiss / Kunststoff, weiss
plafonnier; aluminium, blanc / plastique, blanc

H 50, Ø 600



36W 5400lm



9 002759 975012

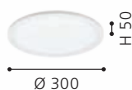

9 002759 975029

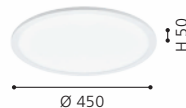

9 002759 975036

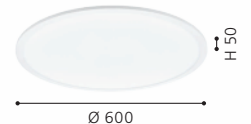



98207



98208



98209



98207 SARSINA-A

ceiling light; aluminium, white / plastic, white
Deckenleuchte; Alu, weiss / Kunststoff, weiss
plafonnier; aluminium, blanc / plastique, blanc

H 50, Ø 300



98208 SARSINA-A

ceiling light; aluminium, white / plastic, white
Deckenleuchte; Alu, weiss / Kunststoff, weiss
plafonnier; aluminium, blanc / plastique, blanc

H 50, Ø 450



98209 SARSINA-A

ceiling light; aluminium, white / plastic, white
Deckenleuchte; Alu, weiss / Kunststoff, weiss
plafonnier; aluminium, blanc / plastique, blanc

H 50, Ø 600



9 002759 982072

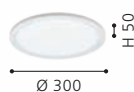

9 002759 982089



9 002759 982096

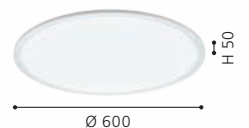



LED PANEL LUMINAIRES

FRAMELESS

ADVANTAGES

- > THE ENTIRE BODY OF THE PANEL IS UTILIZED AS LIGHT SOURCE
 - > ULTRA-FLAT DESIGN
 - > HOMOGENEOUS SURFACE LIGHTING
 - > SIMPLE AND FAST INSTALLATION
 - > ELEGANT SUSPENSION FRAME INCLUDED
 - > DECORATIVE DOMESTIC LIGHTING
 - > WALL AND CEILING LIGHTING
-

VORTEILE

- > DER GESAMTE LEUCHTKÖRPER DIENT ALS LEUCHTFLÄCHE
 - > ULTRAFLACHES DESIGN
 - > HOMOGENE LICHTVERTEILUNG
 - > EINFACHE UND SCHNELLE MONTAGE
 - > INKL. ELEGANTEM SCHWEBERAHMEN
 - > DEKORATIVE WOHNBELEUCHTUNG
 - > WAND- UND DECKENBELEUCHTUNG
-

AVANTAGES

- > LE CORPS ENTIER DU PANNEAU EST UTILISÉ COMME SOURCE DE LUMIÈRE
 - > DESIGN ULTRA PLAT
 - > ÉCLAIRAGE DE SURFACE HOMOGENÈNE
 - > MONTAGE SIMPLE ET RAPIDE
 - > BÂTI FLOTTANT ÉLÉGANT INCLUS
 - > ÉCLAIRAGE DOMESTIQUE DÉCORATIF
 - > ÉCLAIRAGE MURAL ET PLAFONNIER
- 

OVERVIEW

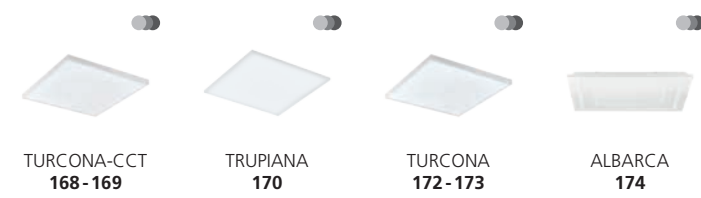

ACCESSORIES INCLUDED

All luminaires including Suspension frame
Alle Leuchten inklusive Schweberahmen
Tous les luminaires inclus bâti flottant



This product is available in different colors and shapes./ Dieser Artikel ist in unterschiedlichen Farben und Formen verfügbar./
Cet article est disponible en différentes couleurs et formes.



99833

LED

TURCONA - CCT

These luminaires have a backlight technology.

Diese Leuchten verfügen über eine Backlight Technology.

Ces luminaires sont équipés d'une technologie de retour.



99833

LED



incl./inkl./inclus

99833 TURCONA-CCT

ceiling light; aluminium, steel, white / plastic, white
 Deckenleuchte; Alu, Stahl, weiss / Kunststoff, weiss
 plafonnier; aluminium, acier, blanc / plastique, blanc

L 287, B 287, H 62



10,8W



1200lm



Remote



9 002759 998332

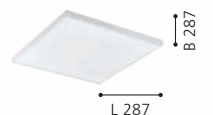



99834



99835



99836



99834 TURCONA-CCT

ceiling light; aluminium, steel, white / plastic, white
Deckenleuchte; Alu, Stahl, weiss / Kunststoff, weiss
plafonnier; aluminium, acier, blanc / plastique, blanc

L 437, B 437, H 70



21,6W



2600lm



Remote



99835 TURCONA-CCT

ceiling light; aluminium, steel, white / plastic, white
Deckenleuchte; Alu, Stahl, weiss / Kunststoff, weiss
plafonnier; aluminium, acier, blanc / plastique, blanc

L 587, B 587, H 70



32,4W



4000lm



Remote



99836 TURCONA-CCT

ceiling light; aluminium, steel, white / plastic, white
Deckenleuchte; Alu, Stahl, weiss / Kunststoff, weiss
plafonnier; aluminium, acier, blanc / plastique, blanc

L 1187, B 287, H 70



32,4W



3800lm



Remote



9 002759 998349

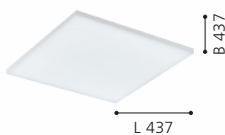

L 437

B 437



9 002759 998356

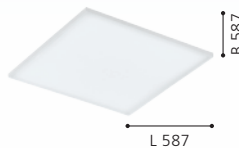

L 587

B 587



9 002759 998363



L 1187

B 287

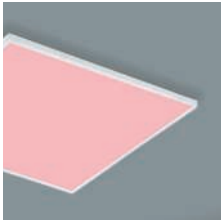

TRUPIANA

These luminaires have RGBTW function on the complete surface.

Diese Leuchten verfügen über eine RGBTW Funktion auf der kompletten Fläche.

Ces luminaires disposent d'une fonction RGBTW sur toute la surface.



900568



incl./inkl./inclus



900569



incl./inkl./inclus



900568 TRUPIANA

ceiling light; aluminium, steel, white / plastic, white
Deckenleuchte; Alu, Stahl, weiss / Kunststoff, weiss
plafonnier; aluminium, acier, blanc / plastique, blanc

L 437, B 437, H 62



20,5W



2900lm



Remote



9 008606 244706

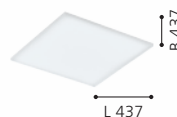

900569 TRUPIANA

ceiling light; aluminium, steel, white / plastic, white
Deckenleuchte; Alu, Stahl, weiss / Kunststoff, weiss
plafonnier; aluminium, acier, blanc / plastique, blanc

L 587, B 587, H 62



31W



4200lm



Remote



9 008606 244713

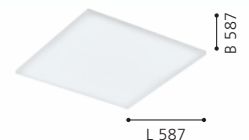



900569

LED





98901



98902



98903



TURCONA

These luminaires have an edgelight technology.

Diese Leuchten verfügen über eine Edgelight Technology.

Ces luminaires sont équipés d'une technologie edgelight.

98901 TURCONA

ceiling light; steel, white / plastic, satin finish
Deckenleuchte; Stahl, weiss / Kunststoff, satiniert
plafonnier; acier, blanc / plastique, satiné

L 300, B 300, H 60



11W 1500lm



9 002759 989019

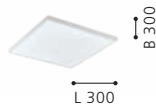

98902 TURCONA

ceiling light; steel, white / plastic, satin finish
Deckenleuchte; Stahl, weiss / Kunststoff, satiniert
plafonnier; acier, blanc / plastique, satiné

L 450, B 450, H 60



20W 2900lm



9 002759 989026

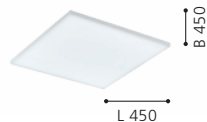

98903 TURCONA

ceiling light; steel, white / plastic, satin finish
Deckenleuchte; Stahl, weiss / Kunststoff, satiniert
plafonnier; acier, blanc / plastique, satiné

L 595, B 595, H 60



33W 4600lm



9 002759 989033

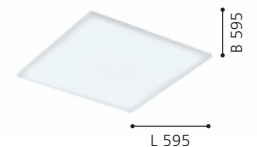



98904

LED



98905

LED

98904 TURCONA

ceiling light; steel, white / plastic, satin finish
Deckenleuchte; Stahl, weiss / Kunststoff, satiniert
plafonnier; acier, blanc / plastique, satiné

L 1200, B 300, H 60

LED

33W

neutral
WHITE

4600lm



98905 TURCONA

ceiling light; steel, white / plastic, satin finish
Deckenleuchte; Stahl, weiss / Kunststoff, satiniert
plafonnier; acier, blanc / plastique, satiné

L 1200, B 100, H 60

LED

19W

neutral
WHITE

3050lm



9 002759 989040



9 002759 989057





900959

LED

incl./inkl./inclus

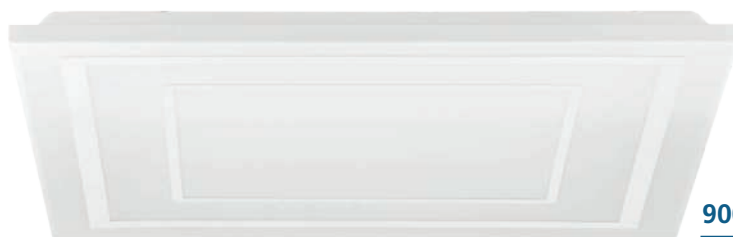

900961

LED

incl./inkl./inclus



900959 ALBARCA

ceiling light; aluminium, steel, white / plastic, white
Deckenleuchte; Alu, Stahl, weiss / Kunststoff, weiss
plafonnier; aluminium, acier, blanc / plastique, blanc

L 438, B 438, H 69

LED

18W



2400lm



Remote



900961 ALBARCA

ceiling light; aluminium, steel, white / plastic, white
Deckenleuchte; Alu, Stahl, weiss / Kunststoff, weiss
plafonnier; aluminium, acier, blanc / plastique, blanc

L 588, B 588, H 69

LED

29W



4100lm



Remote



9 008606 277858



L 438

B 438



9 008606 277865



L 588

B 588

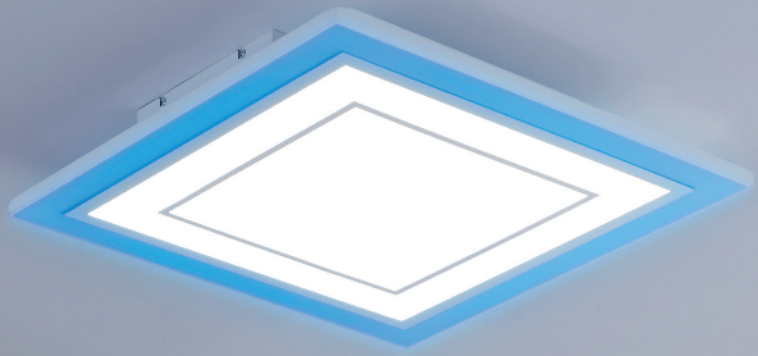

900961

LED



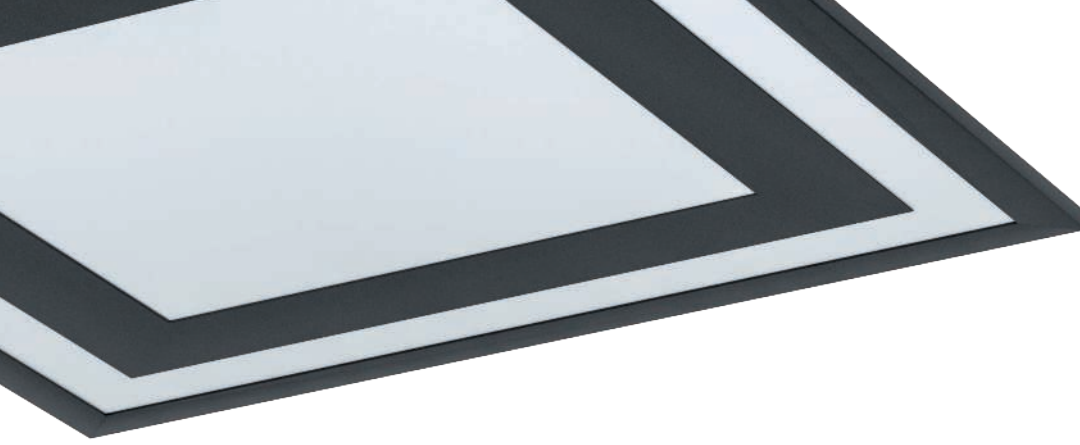

LED PANEL LUMINAIRES

DECORATIVE

ADVANTAGES

- > ULTRA-FLAT DESIGN
 - > HOMOGENEOUS SURFACE LIGHTING
 - > SIMPLE AND FAST INSTALLATION
 - > DECORATIVE DOMESTIC LIGHTING
 - > WALL AND CEILING LIGHTING
-

VORTEILE

- > ULTRAFLACHES DESIGN
 - > HOMOGENE LICHTVERTEILUNG
 - > EINFACHE UND SCHNELLE MONTAGE
 - > DEKORATIVE WOHNBELEUCHTUNG
 - > WAND- UND DECKENBELEUCHTUNG
-

AVANTAGES

- > DESIGN ULTRA PLAT
- > ÉCLAIRAGE DE SURFACE HOMOGENÈ
- > MONTAGE SIMPLE ET RAPIDE
- > ÉCLAIRAGE DOMESTIQUE DÉCORATIF
- > ÉCLAIRAGE MURAL ET PLAFONNIER

OVERVIEW



This product is available in different colors and shapes./ Dieser Artikel ist in unterschiedlichen Farben und Formen verfügbar/
Cet article est disponible en différentes couleurs et formes.



BORDONARA

These luminaires have a TW function on the entire surface and an additional RGB element.

Diese Leuchten verfügen über eine TW Funktion auf der gesamten Fläche und über ein zusätzliches RGB Element.

Ces luminaires disposent d'une fonction TW sur toute la surface et d'un élément RGB supplémentaire.



900571

LED

incl./inkl./inclus



900572

LED

incl./inkl./inclus



900573

LED

incl./inkl./inclus



900571 BORDONARA

ceiling light; aluminium, steel, black, white / plastic, white
Deckenleuchte; Alu, Stahl, schwarz, weiss / Kunststoff, weiss
plafonnier; aluminium, acier, noir, blanc / plastique, blanc

L 450, B 450



21,5W 2800lm

Remote



9 008606 244720

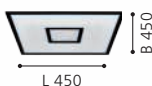

900572 BORDONARA

ceiling light; aluminium, steel, black, white / plastic, white
Deckenleuchte; Alu, Stahl, schwarz, weiss / Kunststoff, weiss
plafonnier; aluminium, acier, noir, blanc / plastique, blanc

L 595, B 595



36W 4900lm

Remote



9 008606 244737



900573 BORDONARA

ceiling light; aluminium, steel, black, white / plastic, white
Deckenleuchte; Alu, Stahl, schwarz, weiss / Kunststoff, weiss
plafonnier; aluminium, acier, noir, blanc / plastique, blanc

L 1195, B 295



35W 5400lm

Remote



9 008606 244744





900571

LED





MARMORATA

Modus 1

Only the outer are glows/ Nur die äußere Fläche leuchtet/ Seule la surface extérieure brille

Modus 2

A "starry sky effect" is created in the central area/ Ein "Sternenhimmelleffekt" entsteht in den zentralen Fläche/ Un "effet de ciel étoilé" est créé dans la zone centrale

Modus 3

The outer area glows and a "starry sky effect" is created in the central area/ Die äußere Fläche leuchtet und ein "Sternenhimmelleffekt" entsteht in den zentralen Fläche/ La surface extérieure brille et un "effet de ciel étoilé" est créé dans la surface centrale



900558

LED



900559

LED

900558 MARMORATA

ceiling light; aluminium, steel, black, white / plastic, white
Deckenleuchte; Alu, Stahl, schwarz, weiss / Kunststoff, weiss
plafonnier; aluminium, acier, noir, blanc / plastique, blanc

H 70, Ø 450

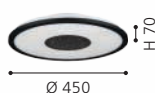
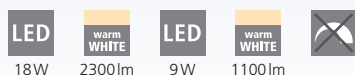

900559 MARMORATA

ceiling light; aluminium, steel, black, white / plastic, white
Deckenleuchte; Alu, Stahl, schwarz, weiss / Kunststoff, weiss
plafonnier; aluminium, acier, noir, blanc / plastique, blanc

L 445, B 445

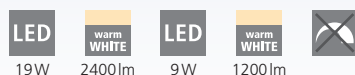

900561 MARMORATA

ceiling light; aluminium, steel, black, white / plastic, white
Deckenleuchte; Alu, Stahl, schwarz, weiss / Kunststoff, weiss
plafonnier; aluminium, acier, noir, blanc / plastique, blanc

L 595, B 295

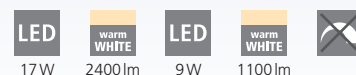



900561

LED



900558

LED



901192

LED



901191

LED



incl./inkl./inclus



901191 BALAZOTE

ceiling light; steel, black / plastic, white
 Deckenleuchte; Stahl, schwarz / Kunststoff, weiss
 plafonnier; acier, noir / plastique, blanc

H 50, Ø 380





REMOTE+

Our new 2.4 GHz REMOTE+ makes it easier than ever to control your luminaires. With its user-friendly design and simple control, you can easily adjust your luminaires to create the perfect ambiance for any occasion:

- › Stepless Dimming
- › Quick Pairing
- › Timer Function
- › Stepless Tunable White
- › Memory Effect
- › Control up to 10 REMOTE+ luminaires

Unsere neue 2,4-GHz REMOTE+ macht die Steuerung Ihrer Leuchten so einfach wie nie zuvor. Mit ihrem benutzerfreundlichen Design und der einfachen Steuerung können Sie Ihre Leuchten ganz einfach einstellen, um das perfekte Ambiente für jede Gelegenheit zu schaffen:

- › Stufenloses Dimmen
- › Schnelle Kopplung
- › Timer-Funktion
- › Stufenlos einstellbares Weiß
- › Memory-Effekt
- › Steuerung von bis zu 10 REMOTE+-Leuchten

Notre nouvelle REMOTE+ 2,4 GHz facilite plus que jamais le contrôle de vos lumières. Grâce à sa conception conviviale et à sa commande simple, vous pouvez facilement régler votre luminaires pour créer l'ambiance parfaite en toute occasion:

- › Gradation progressive
- › appairage rapide
- › Fonction de minuterie
- › Blanc réglable en continu
- › Effet de mémoire
- › Contrôle jusqu'à 10 luminaires REMOTE



901192



incl./inkl./inclus

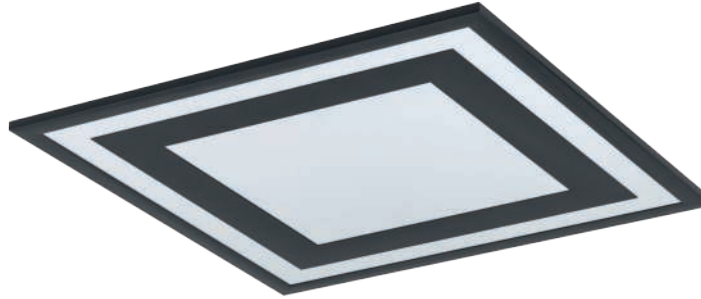

99038



99039



901192 BALAZOTE

ceiling light; steel, black / plastic, white
Deckenleuchte; Stahl, schwarz / Kunststoff, weiss
plafonnier; acier, noir / plastique, blanc

L 360, B 360, H 50



99038 SAVATARILA

ceiling light; aluminium, black / plastic, white
Deckenleuchte; Alu, schwarz / Kunststoff, weiss
plafonnier; aluminium, noir / plastique, blanc

L 450, B 450, H 60



99039 SAVATARILA

ceiling light; aluminium, black / plastic, white
Deckenleuchte; Alu, schwarz / Kunststoff, weiss
plafonnier; aluminium, noir / plastique, blanc

L 595, B 595, H 60



9 008606 312719



L 360



9 002759 990381



L 450



9 002759 990398

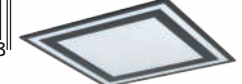

L 595



99841

LED





99842



incl./inkl./inclus



99841



incl./inkl./inclus

99842 LAZARAS

ceiling light; aluminium, steel, white / plastic, white
Deckenleuchte; Alu, Stahl, weiss / Kunststoff, weiss
plafonnier; aluminium, acier, blanc / plastique, blanc

L 450, B 450, H 60



LED

22W

RGB+TW

2700lm



Remote



99841 LAZARAS

ceiling light; aluminium, steel, white / plastic, white
Deckenleuchte; Alu, Stahl, weiss / Kunststoff, weiss
plafonnier; aluminium, acier, blanc / plastique, blanc

H 55, Ø 450



LED

22W

RGB+TW

2700lm



Remote



9 002759 998424



9 002759 998417





RECESSED DOWNLIGHTS

ADVANTAGES

- > DISCREET IN APPEARANCE, PERFECT IN STAGING
 - > SET THE SCENE IN YOUR HOME
 - > IMPRESS WITH THEIR UNCOMPLICATED APPLICATION
 - > ARE ENERGY AND COST-SAVING THANKS TO THE LED CIRCUIT BOARDS AND LED LIGHT SOURCES
-

VORTEILE

- > DEZENT IM AUFTRETEN, PERFEKT IN DER INSZENIERUNG
 - > SETZEN IHR ZUHAUSE IN SZENE
 - > ÜBERZEUGEN MIT IHRER UNKOMPLIZIERTEN ANWENDUNG
 - > SIND AUFGRUND DER LED-PLATINEN UND LED-LEUCHTMITTEL STROM- UND KOSTENSPAREND
-

AVANTAGES

- > DISCRET DANS SON APPARENCE, PARFAIT DANS SA MISE EN SCÈNE
- > METTENT VOTRE MAISON EN SCÈNE
- > CONVAINQUENT PAR LEUR SIMPLICITÉ D'UTILISATION
- > SONT ÉCONOMES EN ÉNERGIE ET EN COÛTS GRÂCE AUX PLATINES LED ET AUX SOURCES LUMINEUSES LED





RECESSED DOWNLIGHTS

HIGH VOLTAGE

ADVANTAGES

- > LOW MOUNTING DEPTH
- > NO TRANSFORMER NECESSARY - THE LATEST LED HIGH-VOLTAGE TECHNOLOGY
- > IDEAL FOR LIGHTING OF ROOMS AND AREAS
- > PLEASANT WARM WHITE LIGHT COLOR
- > LOW TEMPERATURE ENHANCES SAFETY
- > UP TO 80% POWER SAVINGS COMPARED TO INCANDESCENT LAMPS, EASY ON YOUR BUDGET AND THE ENVIRONMENT
- > EASY AND SIMPLE WIRING BY 2-FOLD JUNCTION BOX - EASILY EXPANDABLE

VORTEILE

- > GERINGE EINBAUTIEFE
- > KEIN TRAFO MEHR NOTWENDIG – NEUESTE LED HOCHVOLT TECHNOLOGIE
- > IDEAL ZUR BELEUCHTUNG VON RÄUMEN UND FLÄCHEN
- > ANGENEHME WARM-WEISSE LICHTFARBE
- > GERINGE WÄRMEENTWICKLUNG SORGT FÜR MEHR SICHERHEIT
- > BIS ZU 80% STROMERSPARNIS GEGENÜBER GLÜHLAMPEN. SCHONT IHR BUDGET UND DIE UMWELT
- > EINFACHE UND SICHERE VERKABELUNG DURCH 2-FACH ANSCHLUSSBOX – UNKOMPLIZIERT ERWEITERBAR

AVANTAGES

- > FAIBLE PROFONDEUR DE MONTAGE
- > AUCUN TRANSFORMATEUR NÉCESSAIRE - LA DERNIÈRE TECHNOLOGIE À HAUTE TENSION LED
- > IDÉAL POUR L'ÉCLAIRAGE DES CHAMBRES ET DES ESPACES
- > AGRÉABLE COULEUR DE LUMIÈRE BLANCHE CHAUDE
- > FAIBLE CHALEUR AMÉLIORE LA SÉCURITÉ
- > JUSQU'À 80% D'ÉCONOMIES D'ÉNERGIE PAR RAPPORT AUX LAMPES À INCANDESCENCE. RÉDUIT VOTRE BUDGET ET PROTÈGE L'ENVIRONNEMENT
- > NOTRE BOÎTE DE DEUX JONCTIONS PERMET UN CÂBLAGE SIMPLE ET SÛRE. EN PLUS ELLE EST FACILEMENT EXTENSIBLE.

OVERVIEW



ARENALS
192



CALONGE
194-195



CALONGE RGB
196



PINEDA
198-202



SARTIANO
203



SALABATE
204



SALICETO
204-209



ZARATE
210



MECINOS
211



RAPITA
212-215



This product is available in different colors and shapes./ Dieser Artikel ist in unterschiedlichen Farben und Formen verfügbar./
Cet article est disponible en différentes couleurs et formes.



1 SIMPLE INSTALLATION!

Einfache Montage! / Montage simple !

Universally usable in walls or ceilings thanks to its small installation depth!

Durch die geringe Einbautiefe universell einsetzbar, ob Wand oder Decke!

Emploi universel dû à la faible profondeur de montage, que ce soit au mur ou au plafond !

2 QUICK AND SAFE CONNECTION!

Schnelles und sicheres Anschließen! /
Branchement rapide et sûr !

Easy wiring with the practical connection box!
No transformer is needed anymore thanks to
state of-the-art high-voltage technology!

Leichtes Verkabeln durch die praktische An-
schlussbox! Durch moderne Hochvolt-Technik
wird kein Trafo mehr benötigt!

Câbler simplement avec le boîtier de
branchement pratique ! Grâce à la technique de
haute tension moderne, plus besoin de transfor-
mateur !



3 PERFECT FIT!

Perfekter Halt! / Maintien parfait !

The integrated holding brackets permit simple
installation and guarantee for a precise fit!

Die integrierten Halteklammern ermöglichen
einen einfachen Einbau und sorgen für garantierte
Passgenauigkeit!

Les griffes de maintien intégrées permettent un
montage simple et assurent un parfait ajustement !





4

FLUSH INSTALLATION!

FLÄCHENBÜNDIGER EINBAU! / MONTAGE À FLEUR !

The slim build permits fitting installation in any surface!

Die schlanke Bauform ermöglicht den passenden Einbau bei jeder Fläche!

La structure fine permet le montage adéquat avec chaque surface !



ARENALS

Different colour rings included.

Verschiedene Farbringe enthalten.

Différents anneaux de couleur inclus.



901167

LED



901167 ARENALS

recessed light; aluminium, white / plastic, white

Einbauleuchte; Alu, weiss / Kunststoff, weiss

luminaire encastrable; aluminium, blanc / plastique, blanc

H 38, Ø 92

LED

1x 4,9W

warm
WHITE

550 lm



Ø 75



9 008606 315994



Ø 92



901167

LED





900915

LED



900912

LED



900914

LED

900912 CALONGE

recessed light; plastic, white
 Einbauleuchte; Kunststoff, weiss
 luminaire encastrable; plastique, blanc

Ø 100, A 45



4,8W 620lm

Ø70



9 008606 277612



Ø 100

900914 CALONGE

recessed light; plastic, black, white
 Einbauleuchte; Kunststoff, schwarz, weiss
 luminaire encastrable; plastique, noir, blanc

Ø 100, A 45



4,8W 620lm

Ø70



9 008606 277636



Ø 100



900913

LED



900915

LED

CALONGE

With memory function.

Mit Memory-Funktion.

Avec fonction mémoire.



900913 CALONGE

recessed light; plastic, white
 Einbauleuchte; Kunststoff, weiss
 luminaire encastrable; plastique, blanc

Ø 100, A 45

LED

3x 4,8W

warm
WHITE

1860lm



Ø 70



900915 CALONGE

recessed light; plastic, black, white
 Einbauleuchte; Kunststoff, schwarz, weiss
 luminaire encastrable; plastique, noir, blanc

Ø 100, A 45

LED

3x 4,8W

warm
WHITE

1860lm



Ø 70



9 008606 277629



Ø 100



9 008606 277643



Ø 100



DESIGN
HIGHLIGHT
DETAIL



901117



IP20/44



901118



IP20/44

901117 CALONGE RGB

recessed light; plastic, white
Einbauleuchte; Kunststoff, weiss
luminaire encastrable; plastique, blanc

H 32, Ø 98



3x 3,8W



3x 520lm



Ø 75



IP20/44



9 008606 297382



Ø 98

901118 CALONGE RGB

recessed light; plastic, black, white
Einbauleuchte; Kunststoff, schwarz, weiss
luminaire encastrable; plastique, noir, blanc

H 32, Ø 98



3x 3,8W



3x 520lm



Ø 75



IP20/44



9 008606 297399



Ø 98



901118



IP20/44





PINEDA

Ø 78, ET 35

recessed light
Einbauleuchte
luminaire encastrable



Material / Colour	Size	Cutout	Quantity	Watt	Lumen	IP class	Item no.	EAN code
plastic, white Kunststoff, weiss plastique, blanc	Ø 78, ET 35	Ø 65		4,9W	360lm		95817	9 002759 958176
	Ø 78, ET 35	Ø 65	3	3 x 4,9W	1080lm		95821	9 002759 958213
plastic, satin nickel Kunststoff, nickel-matt plastique, nickel mat	Ø 78, ET 35	Ø 65		4,9W	360lm		95819	9 002759 958190
	Ø 78, ET 35	Ø 65	3	3 x 4,9W	1080lm		95823	9 002759 958237
plastic, chrome Kunststoff, chrom plastique, chrome	Ø 78, ET 35	Ø 65		4,9W	360lm		95818	9 002759 958183
	Ø 78, ET 35	Ø 65	3	3 x 4,9W	1080lm		95822	9 002759 958220
plastic, black Kunststoff, schwarz plastique, noir	Ø 78, ET 35	Ø 65		4,9W	360lm		900743	9 008606 253708
	Ø 78, ET 35	Ø 65	3	3 x 4,9W	1080lm		900744	9 008606 253715













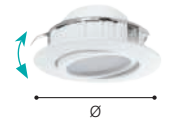

















PINEDA

Ø 84, ET 40

recessed light
Einbauleuchte
luminaire encastrable



Material / Colour	Size	Cutout	Quantity	Watt		Lumen		Item no.	EAN code
 plastic, white Kunststoff, weiss plastique, blanc	Ø 84, ET 40	Ø 72	3	3 x 4,9W	 warm WHITE	1080lm		95851	9 002759 958510
	Ø 84, ET 40	Ø 72	3	3 x 5,5W	 warm WHITE	1080lm		95857	9 002759 958572
 plastic, satin nickel Kunststoff, nickel-matt plastique, nickel mat	Ø 84, ET 40	Ø 72	3	3 x 4,9W	 warm WHITE	1080lm		95853	9 002759 958534
	Ø 84, ET 40	Ø 72		5,5W	 warm WHITE	360lm		95856	9 002759 958565
	Ø 84, ET 40	Ø 72	3	3 x 5,5W	 warm WHITE	1080lm		95859	9 002759 958596
 plastic, chrome Kunststoff, chrom plastique, chrome	Ø 84, ET 40	Ø 72	3	3 x 4,9W	 warm WHITE	1080lm		95852	9 002759 958527
	Ø 84, ET 40	Ø 72		5,5W	 warm WHITE	360lm		95855	9 002759 958558
	Ø 84, ET 40	Ø 72	3	3 x 5,5W	 warm WHITE	1080lm		95858	9 002759 958589
 plastic, black Kunststoff, schwarz plastique, noir	Ø 84, ET 40	Ø 72		5,5W	 warm WHITE	360lm		900748	9 008606 253753
	Ø 84, ET 40	Ø 72	3	3 x 5,5W	 warm WHITE	1080lm		900749	9 008606 253760



95843

LED



95844

LED



95846

LED



95843 PINEDA

recessed light; plastic, satin nickel
Einbauleuchte; Kunststoff, nickel-matt
luminaire encastrable; plastique, nickel mat

95846 PINEDA

recessed light; plastic, satin nickel
Einbauleuchte; Kunststoff, nickel-matt
luminaire encastrable; plastique, nickel mat

95844 PINEDA

recessed light; plastic, white
Einbauleuchte; Kunststoff, weiss
luminaire encastrable; plastique, blanc

L 84, B 84, ET 40



4,9W 360lm

Ø72

L 84, B 84, ET 40



3x 4,9W 1080lm

Ø72

L 84, B 84, ET 40



3x 4,9W 1080lm

Ø72



9 002759 958435



9 002759 958466



9 002759 958442





32896

LED

32896 SARTIANO

recessed light; plastic, white
 Einbauleuchte; Kunststoff, weiss
 luminaire encastrable; plastique, blanc

Ø 90, ET 45

LED

warm
WHITE



3x 4,6W 3x 500lm

Ø73



9 002759 328962



Ø 90



32896

LED



SALABATE

Ø 88, ET 52

recessed light
Einbauleuchte
luminaire encastrable



Material / Colour	Size	Cutout	Watt		Lumen	IP class	Item no.	EAN code
aluminium, white / glass, clear Alu, weiss / Glas, klar aluminium, blanc / verre, transparent	Ø 88, ET 52	Ø 68	6W	warm WHITE	380lm	IP20/44	98238	9 002759 982386
	Ø 88, ET 52	Ø 68	6W	neutral WHITE	450lm	IP20/44	98241	9 002759 982416
aluminium, black / glass, clear Alu, schwarz / Glas, klar aluminium, noir / verre, transparent	Ø 88, ET 52	Ø 68	6W	warm WHITE	380lm	IP20/44	99493	9 002759 994938
	Ø 88, ET 52	Ø 68	6W	neutral WHITE	450lm	IP20/44	99494	9 002759 994945



SALICETO

H 42, Ø 88, ET 50

recessed light
Einbauleuchte
luminaire encastrable

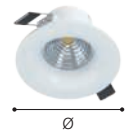

Material / Colour	Size	Cutout	Watt		Lumen	IP class	Item no.	EAN code
aluminium, white Alu, weiss aluminium, blanc	H 42, Ø 88, ET 50	Ø 68	6W	warm WHITE	380lm	IP20/44	98243	9 002759 982430
aluminium, satin nickel Alu, nickel-matt aluminium, nickel mat	H 42, Ø 88, ET 50	Ø 68	6W	warm WHITE	380lm	IP20/44	98244	9 002759 982447
aluminium, black Alu, schwarz aluminium, noir	H 42, Ø 88, ET 50	Ø 68	6W	warm WHITE	380lm	IP20/44	98607	9 002759 986070
	H 42, Ø 88, ET 50	Ø 68	6W	neutral WHITE	500lm	IP20/44	33996	9 002759 339968



IP44



	0	1	2	3
EU	X	X	✓	✓
FR	X	X	X	✓

SALABETE

Water-splash protected luminaires are labelled with an IP value.

Spritzwassergeschützte Leuchten sind mittels IP-Wert gekennzeichnet.

Les luminaires protégés contre les projections d'eau sont identifiés au moyen de la valeur IP.



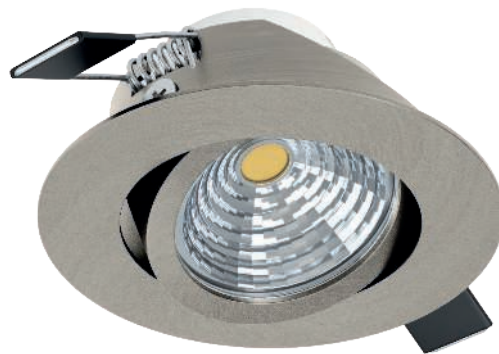

SALICETO

H 42, Ø 88, ET 50

recessed light
Einbauleuchte
luminaire encastrable

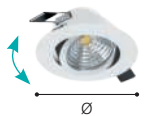

Material / Colour	Size	Cutout	Quantity	Watt	Lumen	Item no.	EAN code
aluminium, white Alu, weiss aluminium, blanc	H 42, Ø 88, ET 50	Ø 68		6W	warm WHITE 450lm	98301	9 002759 983017
	H 42, Ø 88, ET 50	Ø 68	3	3 x 6W	warm WHITE 1350lm	900745	9 008606 253722
	H 42, Ø 88, ET 50	Ø 68		6W	neutral WHITE 500lm	98305	9 002759 983055
	H 42, Ø 88, ET 50	Ø 68	3	3 x 6W	neutral WHITE 1350lm	33391	9 002759 333911
aluminium, satin nickel Alu, nickel-matt aluminium, nickel mat	H 42, Ø 88, ET 50	Ø 68		6W	warm WHITE 450lm	98303	9 002759 983031
	H 42, Ø 88, ET 50	Ø 68	3	3 x 6W	warm WHITE 1350lm	900746	9 008606 253739
	H 42, Ø 88, ET 50	Ø 68		6W	neutral WHITE 500lm	98307	9 002759 983079
aluminium, black Alu, schwarz aluminium, noir	H 42, Ø 88, ET 50	Ø 68		6W	warm WHITE 380lm	98609	9 002759 986094
	H 42, Ø 88, ET 50	Ø 68	3	3 x 6W	warm WHITE 1350lm	900747	9 008606 253746
	H 42, Ø 88, ET 50	Ø 68		6W	neutral WHITE 500lm	33997	9 002759 339975



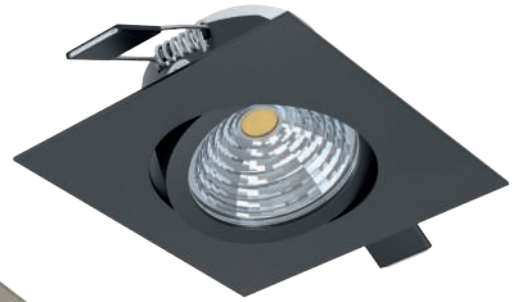

SALICETO

L 88, B 88, H 42, ET 50

recessed light
Einbauleuchte
luminaire encastrable

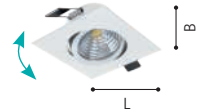

Material / Colour	Size	Cutout	Watt		Lumen		Item no.	EAN code
aluminium, white Alu, weiss aluminium, blanc	L 88, B 88, H 42, ET 50	Ø 68	6W		450lm		98302	9 002759 983024
	L 88, B 88, H 42, ET 50	Ø 68	6W		500lm		98306	9 002759 983062
aluminium, satin nickel Alu, nickel-matt aluminium, nickel mat	L 88, B 88, H 42, ET 50	Ø 68	6W		450lm		98304	9 002759 983048
	L 88, B 88, H 42, ET 50	Ø 68	6W		500lm		98308	9 002759 983086
aluminium, black Alu, schwarz aluminium, noir aluminium, black / glass, clear, white Alu, schwarz / Glas, klar, weiss aluminium, noir / verre, transparent, blanc	L 88, B 88, H 42, ET 50	Ø 68	6W		380lm		98611	9 002759 986117
	L 88, B 88, H 42, ET 50	Ø 68	6W		450lm		33394	9 002759 333942



SALICETO

L 88, B 88, H 42, ET 50

recessed light
Einbauleuchte
luminaire encastrable

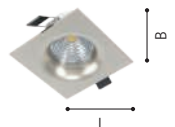

Material / Colour	Size	Cutout	Watt		Lumen		Item no.	EAN code
aluminium, satin nickel / glass, clear Alu, nickel-matt / Glas, klar aluminium, nickel mat / verre, transparent	L 88, B 88, H 42, ET 50	Ø 68	6W		380lm		98472	9 002759 984724
	L 88, B 88, H 42, ET 50	Ø 68	6W		450lm		98474	9 002759 984748



96901

LED

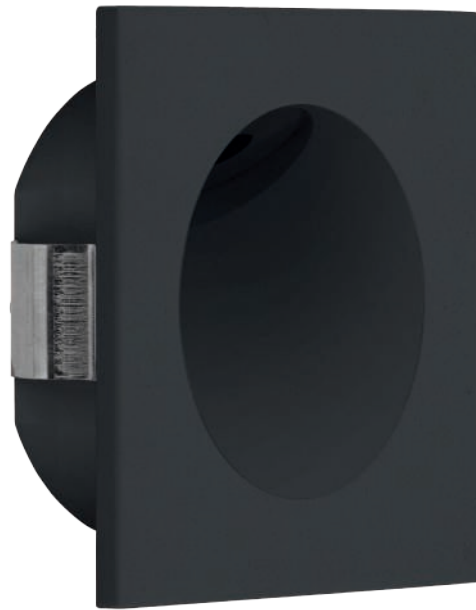

900251

LED

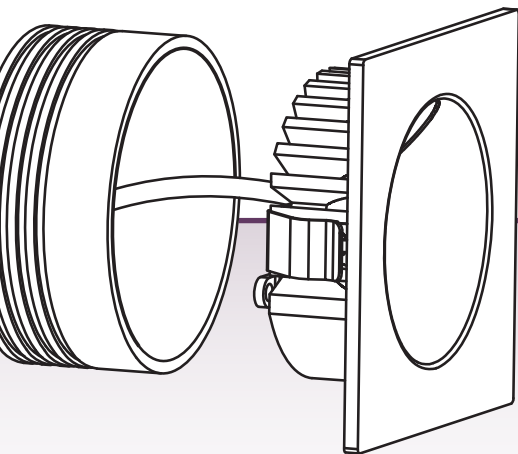

96901 ZARATE

recessed light; cast aluminium, white / plastic, white
 Einbauleuchte; Aluguss, weiss / Kunststoff, weiss
 luminaire encastrable; fonte d'aluminium, blanc / plastique, blanc

L 80, B 80, ET 40



2W



90lm



Ø63

900251 ZARATE

recessed light; cast aluminium, black / plastic, white
 Einbauleuchte; Aluguss, schwarz / Kunststoff, weiss
 luminaire encastrable; fonte d'aluminium, noir / plastique, blanc

L 80, B 80, ET 40



2W



90lm



Ø63

ZARATE, MECINOS

Including plaster ring.

Inklusive Einputzring.

Y compris l'anneau de plâtre.



9 002759 969011



L 80



9 008606 285778

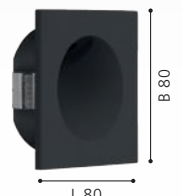

L 80



99643

LED



99644

LED



99644

LED



99643 MECINOS

recessed light; steel, white
 Einbauleuchte; Stahl, weiss
 luminaire encastrable; acier, blanc

L 80, B 80, H 3

LED

2W

warm
 WHITE

90lm



Ø68



9 002759 996437

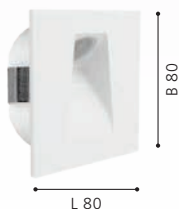

99644 MECINOS

recessed light; steel, black
 Einbauleuchte; Stahl, schwarz
 luminaire encastrable; acier, noir

L 80, B 80, H 3

LED

2W

warm
 WHITE

90lm



Ø65



9 002759 996444





900965



900962



RAPITA



All sizes with installation diameter 68 mm.

Alle Größen mit Einbaudurchmesser 68 mm.

Toutes les tailles avec un diamètre d'installation de 68 mm.

900962 RAPITA

recessed light; aluminium, white / plastic, white

Einbauleuchte; Alu, weiss / Kunststoff, weiss

luminaire encastrable; aluminium, blanc / plastique, blanc

H 20, Ø 75



4,5W



600lm



Ø68



IP20/65



Ø 75



900963



IP20/65



900964



IP20/65



900965



IP20/65

900963 RAPITA

recessed light; aluminium, white / plastic, white
Einbauleuchte; Alu, weiss / Kunststoff, weiss
luminaire encastrable; aluminium, blanc / plastique, blanc

H 20, Ø 100



5,5W



750lm



Ø68



IP20/65



9 008606 275090



Ø 100

900964 RAPITA

recessed light; aluminium, white / plastic, white
Einbauleuchte; Alu, weiss / Kunststoff, weiss
luminaire encastrable; aluminium, blanc / plastique, blanc

H 20, Ø 155



11,5W



1550lm



Ø68



IP20/65



9 008606 275106



Ø 155

900965 RAPITA

recessed light; aluminium, white / plastic, white
Einbauleuchte; Alu, weiss / Kunststoff, weiss
luminaire encastrable; aluminium, blanc / plastique, blanc

H 20, Ø 215



18W



2400lm



Ø68



IP20/65



9 008606 275113



Ø 215

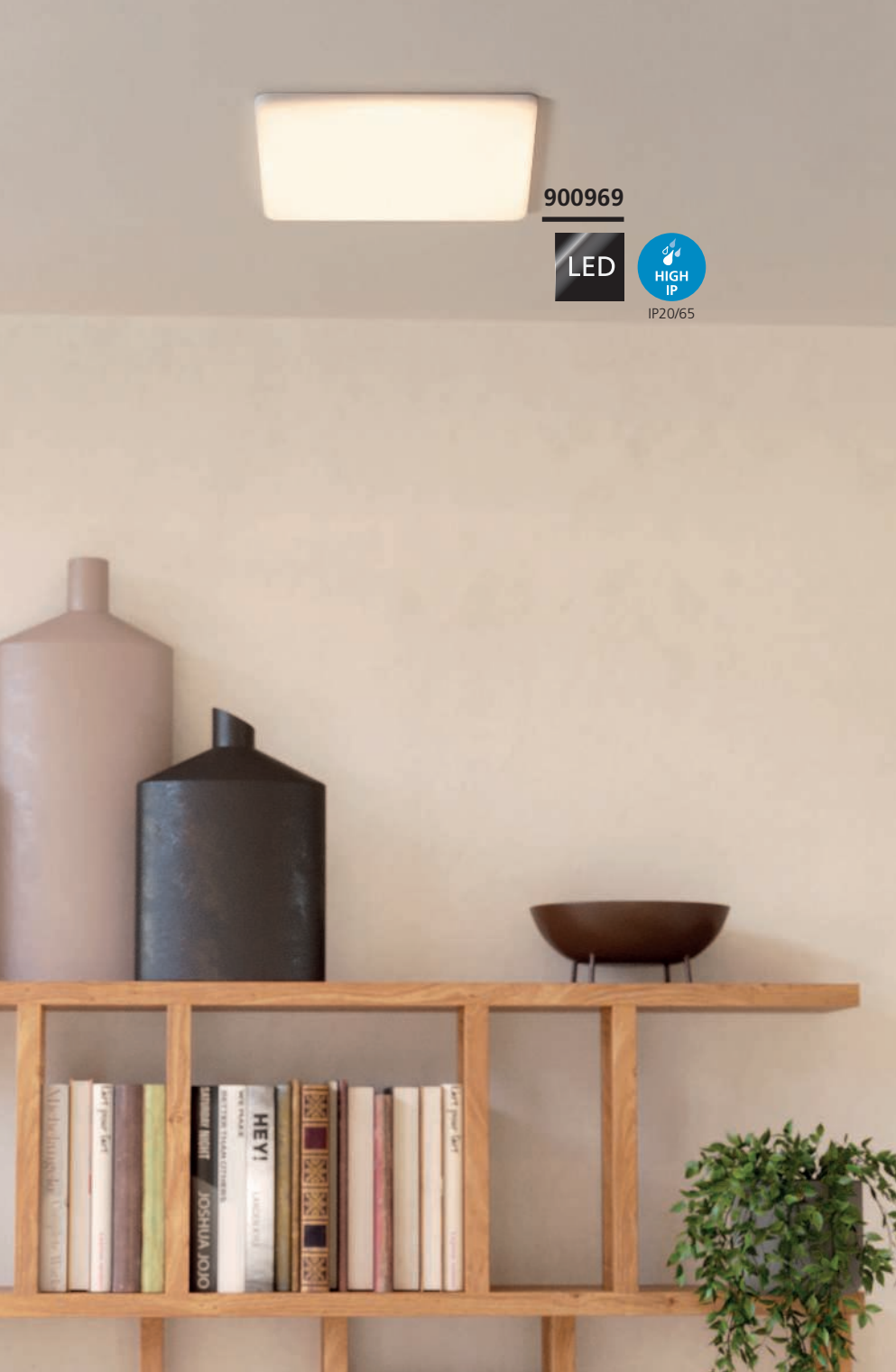

900969



IP20/65



900966



IP20/65

RAPITA



All sizes with installation diameter 68 mm.

Alle Größen mit Einbaudurchmesser 68 mm.

Toutes les tailles avec un diamètre d'installation de 68 mm.

900966 RAPITA

recessed light; aluminium, white / plastic, white

Einbauleuchte; Alu, weiss / Kunststoff, weiss

luminaire encastrable; aluminium, blanc / plastique, blanc

L 75, B 75, H 20



4,5W



600lm



Ø68



IP20/65



9 008606 275120



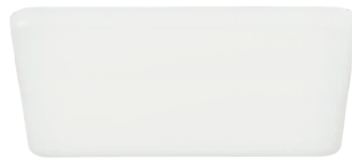

900967



IP20/65

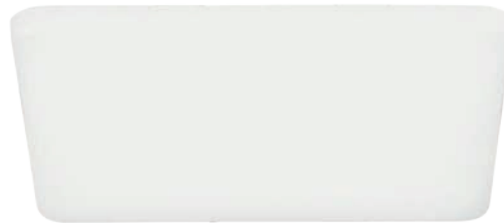

900968



IP20/65

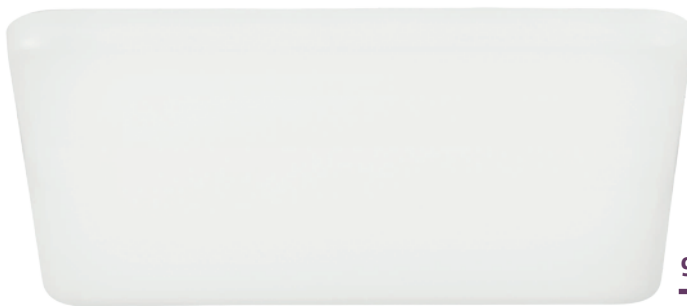

900969



IP20/65

900967 RAPITA

recessed light; aluminium, white / plastic, white
Einbauleuchte; Alu, weiss / Kunststoff, weiss
luminaire encastrable; aluminium, blanc / plastique, blanc

L 100, B 100, H 20



5,5W



750lm



Ø68



IP20/65



9 008606 275137

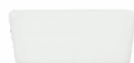

L 100

B 100

900968 RAPITA

recessed light; aluminium, white / plastic, white
Einbauleuchte; Alu, weiss / Kunststoff, weiss
luminaire encastrable; aluminium, blanc / plastique, blanc

L 155, B 155, H 20



11,5W



1550lm



Ø68



IP20/65



9 008606 275144

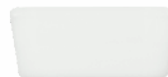

L 155

B 155

900969 RAPITA

recessed light; aluminium, white / plastic, white
Einbauleuchte; Alu, weiss / Kunststoff, weiss
luminaire encastrable; aluminium, blanc / plastique, blanc

L 215, B 215, H 20



18W



2400lm



Ø68



IP20/65



9 008606 275151

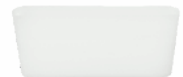

L 215

B 215



RECESSED DOWNLIGHTS

LOW VOLTAGE

ADVANTAGES

- > SLIM DESIGN WITH MINIMAL INSTALLATION DEPTH, MAKING IT IDEAL FOR CEILING STRUCTURES WITH LITTLE SPACE
 - > UNIFORM DISTRIBUTION OF LIGHT - IDEAL FOR ILLUMINATING SPACES AND SURFACES
 - > LOW TEMPERATURE ENHANCES SAFETY
 - > UP TO 80% POWER SAVINGS COMPARED TO INCANDESCENT LAMPS, EASY ON YOUR BUDGET AND THE ENVIRONMENT
 - > IMPL. CABLING THROUGH INTEGRATED TERMINAL CONNECTOR ON DRIVER
-

VORTEILE

- > SCHLANKE BAUFORM MIT MINIMALER EINBAUTIEFE, DAHER IDEAL FÜR DECKEN-KONSTRUKTIONEN MIT WENIG PLATZ
 - > HOMOGENE LICHTVERTEILUNG - IDEAL ZUR BELEUCHTUNG VON RÄUMEN UND FLÄCHEN
 - > GERINGE WÄRMEENTWICKLUNG SORGT FÜR MEHR SICHERHEIT
 - > BIS ZU 80% STROMERSPARNIS GEGENÜBER GLÜHLAMPEN, SCHONT IHR BUDGET UND DIE UMWELT
 - > EINFACHE VERKABELUNG DURCH INTEGRIERTEN KLEMMANSCHLUSS AM TREIBER
-

AVANTAGES

- > CONCEPTION MINCE AVEC LA PROFONDEUR D'INSTALLATION MINIMALE, IDÉAL POUR LES STRUCTURES DE PLAFOND AVEC PEU D'ESPACE
- > DISTRIBUTION UNIFORME DE LA LUMIÈRE - IDÉAL POUR L'ILLUMINATION DES ESPACES ET SURFACES
- > FAIBLE CHALEUR AMÉLIORE LA SÉCURITÉ
- > JUSQU'À 80% D'ÉCONOMIES D'ÉNERGIE PAR RAPPORT AUX LAMPES À INCANDESCENCE, RÉDUIT VOTRE BUDGET ET PROTÈGE L'ENVIRONNEMENT
- > CÂBLAGE SIMPLE VIA LE CONNECTEUR DE TERMINAL INTÉGRÉ SUR CONDUCTEUR

OVERVIEW



CHANGO
218



This product is available in different colors and shapes./ Dieser Artikel ist in unterschiedlichen Farben und Formen verfügbar./
Cet article est disponible en différentes couleurs et formes.



97079



IP44

CHANGO

- | | | |
|------------------------------------------------------------------------------------------------------------------------------------------------------------------------------------------------------------------------------------------------------------------------------------------------------------------------------------------------------------------|-------------------------------------------------------------------------------------------------------------------------------------------------------------------------------------------------------------------------------------------------------------------------------------------------------------------------------------------------------------------|----------------------------------------------------------------------------------------------------------------------------------------------------------------------------------------------------------------------------------------------------------------------------------------------------------------------------------------------------------------------------------------|
| <ul style="list-style-type: none"> > "Starry Sky" 3 Spot Set > Simple installation > Pre-assembled connecting box > Plug & Play > Desktop driver > Operable with 2 – 3 spotheads incl. short-connector > Cable length = 2 m > Cutout dimension = 16 mm | <ul style="list-style-type: none"> > "Sternenhimmel" 3 Spot Set > Einfache Montage > Vorkonfigurierte Anschlußbox > Plug & Play > Desktop Treiber > Verwendbar mit 2 – 3 Spotköpfen inkl. Verbinder > Kabellänge = 2 m > Ausschnitt Durchmesser = 16 mm | <ul style="list-style-type: none"> > Ensemble 3 spots "Ciel étoilé " > Installation simple > Boîte de connexion pré-assemblée > Branchez & jouez > Pilote de bureau > Utilisable avec 2 à 3 têtes incl. connecteur court > Longueur du câble = 2 m > Cote de découpe = 16 mm |
|------------------------------------------------------------------------------------------------------------------------------------------------------------------------------------------------------------------------------------------------------------------------------------------------------------------------------------------------------------------|-------------------------------------------------------------------------------------------------------------------------------------------------------------------------------------------------------------------------------------------------------------------------------------------------------------------------------------------------------------------|----------------------------------------------------------------------------------------------------------------------------------------------------------------------------------------------------------------------------------------------------------------------------------------------------------------------------------------------------------------------------------------|

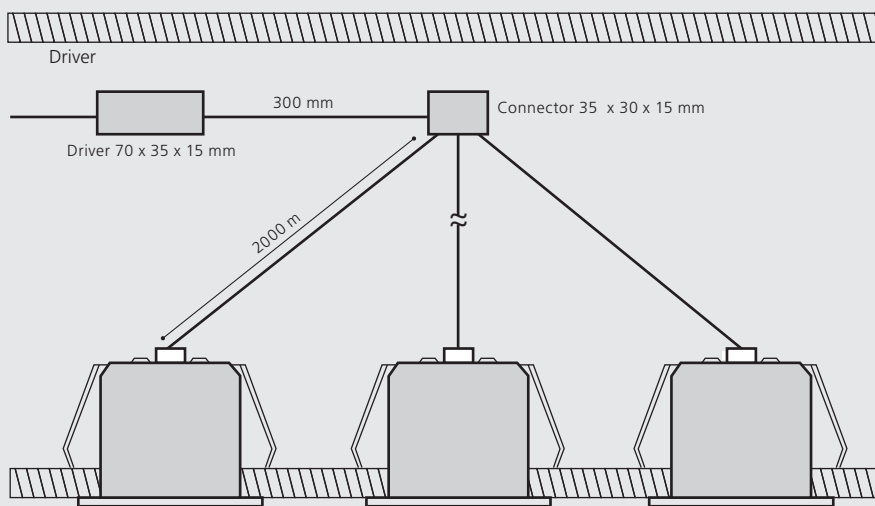

97079 CHANGO

recessed light; aluminium, white
 Einbauleuchte; Alu, weiss
 luminaire encastrable; aluminium, blanc

H 22, Ø 32, ET 25



3x 1 W



300 lm



Ø 15



IP44



9 002759 970796



Ø 32



97079

LED



IP44

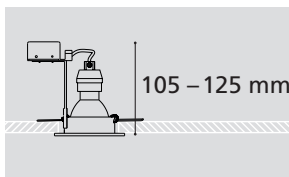

RECESSED DOWNLIGHTS

WITH SOCKET

ADVANTAGES

- > PROVEN TECHNOLOGY, CUSTOMIZED SOLUTIONS IN EVERY PRICE CATEGORY
- > DEPENDING ON THE SELECTED LAMPS APPROPRIATE FOR ILLUMINATING AREAS AND ROOMS OR FOR ACCENT LIGHTING
- > GREAT COLORS AND SHAPES
- > UP TO 80% POWER SAVINGS COMPARED TO INCANDESCENT LAMPS, EASY ON YOUR BUDGET AND THE ENVIRONMENT
- > LAMP REPLACEABLE FROM THE BOTTOM

VORTEILE

- > BEWÄHRTE TECHNOLOGIE, INDIVIDUELLE LÖSUNGEN IN JEDER PREISKLASSE
- > JE NACH EINGESETZTEM LEUCHTMITTEL ZUR BELEUCHTUNG VON FLÄCHEN UND RÄUMEN ODER ZUR AKZENTBELEUCHTUNG
- > GROSSE FARBEN- UND FORMENVIELFALT
- > BIS ZU 80% STROMERSPARNIS GEGENÜBER GLÜHLAMPEN, SCHONT IHR BUDGET UND DIE UMWELT
- > LEUCHTMITTEL VON UNTEN TAUSCHBAR

AVANTAGES

- > UNE TECHNOLOGIE ÉPROUVÉE, SOLUTIONS INDIVIDUELLES DANS CHAQUE CATÉGORIE DE PRIX
- > SELON LES LAMPES CHOISIES APTÉ À ÉCLAIRER DES SURFACES ET DES CHAMBRES OU POUR L'ÉCLAIRAGE ACCENTUEL
- > COULEURS ET FORMES FANTASTIQUES
- > JUSQU'À 80% D'ÉCONOMIES D'ÉNERGIE PAR RAPPORT AUX LAMPES À INCANDESCENCE, RÉDUIT VOTRE BUDGET ET PROTÈGE L'ENVIRONNEMENT
- > LAMPE REMPLAÇABLE PAR LE BAS

OVERVIEW



AREITIO
222



FAVAZZINA
224-225



PENETO
226-231



TEDO
232



TEDO 1
233



CAROSSO
234-237



This product is available in different colors and shapes./ Dieser Artikel ist in unterschiedlichen Farben und Formen verfügbar./
Cet article est disponible en différentes couleurs et formes.



98639

LED



98637

LED

98639 AREITIO

recessed light; aluminium, brushed aluminium
 Einbauleuchte; Alu, alu-gebürstet
 luminaire encastrable; aluminium, aluminium brossé

Ø 100, ET 115



GU10 3x 4,6W 3x 400lm Ø79

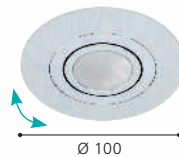

98637 AREITIO

recessed light; aluminium, brushed aluminium
 Einbauleuchte; Alu, alu-gebürstet
 luminaire encastrable; aluminium, aluminium brossé

L 95, B 95, ET 115



GU10 3x 4,6W 3x 400lm Ø75

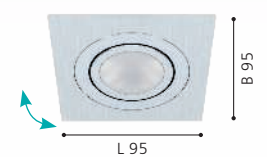



98639

LED





901756

LED



901755

LED



901757

LED

901756 FAVAZZINA

recessed light; steel, white
 Einbauleuchte; Stahl, weiss
 luminaire encastrable; acier, blanc

901757 FAVAZZINA

recessed light; steel, satin nickel
 Einbauleuchte; Stahl, nickel-matt
 luminaire encastrable; acier, nickel mat

901755 FAVAZZINA

recessed light; steel, black
 Einbauleuchte; Stahl, schwarz
 luminaire encastrable; acier, noir

Ø 88, ET 65



Ø 88, ET 65



Ø 88, ET 65

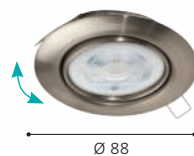
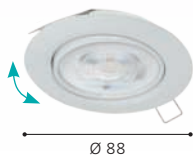



901759

LED



IP44



FAVAZZINA

Low installation depth despite GU10 socket thanks to the new light source with low profile. Bulb 110351 is included in the scope of delivery.

Niedrige Einbautiefe trotz GU10-Fassung dank des neuen Leuchtmittels mit niedrigem Profil. Leuchtmittel 110351 ist im Lieferumfang enthalten.

Faible profondeur d'installation malgré la douille GU10 grâce à la nouvelle source lumineuse à profil bas. L'ampoule 110351 est incluse dans la livraison.



901761

LED



IP44



901758

LED



IP44

901759 FAVAZZINA

recessed light; steel, white / glass, clear
 Einbauleuchte; Stahl, weiss / Glas, klar
 luminaire encastrable; acier, blanc / verre, transparent

901761 FAVAZZINA

recessed light; steel, satin nickel / glass, clear
 Einbauleuchte; Stahl, nickel-matt / Glas, klar
 luminaire encastrable; acier, nickel mat / verre, transparent

901758 FAVAZZINA

recessed light; steel, black / glass, clear
 Einbauleuchte; Stahl, schwarz / Glas, klar
 luminaire encastrable; acier, noir / verre, transparent

Ø 85, ET 70

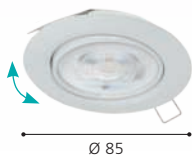

Ø 85, ET 70

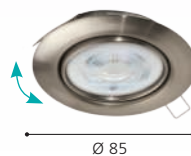

Ø 85, ET 70





94235

LED



94237

LED



94236

LED

94235 PENETO

recessed light; steel, white
 Einbauleuchte; Stahl, weiss
 luminaire encastrable; acier, blanc

Ø 78, ET 115



94236 PENETO

recessed light; steel, chrome
 Einbauleuchte; Stahl, chrom
 luminaire encastrable; acier, chrome

Ø 78, ET 115



94237 PENETO

recessed light; steel, satin nickel
 Einbauleuchte; Stahl, nickel-matt
 luminaire encastrable; acier, nickel matt

Ø 78, ET 115



9 002759 942359



Ø 78



9 002759 942366



Ø 78



9 002759 942373



Ø 78



900753

LED



900754

LED



900753 PENETO

recessed light; steel, black
Einbauleuchte; Stahl, schwarz
luminaire encastrable; acier, noir

Ø 78, ET 115



GU10



1x 2,8W



warm
WHITE

1x
250lm



Ø65



900754 PENETO

recessed light; steel, black
Einbauleuchte; Stahl, schwarz
luminaire encastrable; acier, noir

Ø 78, ET 115



GU10



3x 2,8W



warm
WHITE

3x
250lm



Ø65



9 008606 253852



Ø 78



9 008606 253869



Ø 78



900751

LED



94239

LED



94242

LED

900751 PENETO

recessed light; steel, black
Einbauleuchte; Stahl, schwarz
luminaire encastrable; acier, noir

94239 PENETO

recessed light; steel, white
Einbauleuchte; Stahl, weiss
luminaire encastrable; acier, blanc

94242 PENETO

recessed light; steel, satin nickel
Einbauleuchte; Stahl, nickel-matt
luminaire encastrable; acier, nickel mat

Ø 87, ET 115



Ø 87, ET 115



Ø 87, ET 115



Ø 87



Ø 87



Ø 87





900752

LED

900752 PENETO

recessed light; steel, black
 Einbauleuchte; Stahl, schwarz
 luminaire encastrable; acier, noir

Ø 87, ET 115



GU10



3x 4,6W



warm
 WHITE
 3x
 400lm



Ø 70

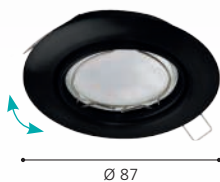

900751

LED





94406





94406

LED



94407

LED



94408

LED

94406 PENETO

recessed light; steel, white
 Einbauleuchte; Stahl, weiss
 luminaire encastrable; acier, blanc

Ø 87, ET 115



GU10 3x 4,6W 3x 400lm Ø 70



9 002759 944063

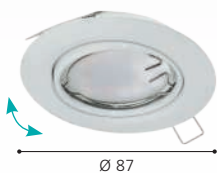

94407 PENETO

recessed light; steel, chrome
 Einbauleuchte; Stahl, chrom
 luminaire encastrable; acier, chrome

Ø 87, ET 115



GU10 3x 4,6W 3x 400lm Ø 70



9 002759 944070

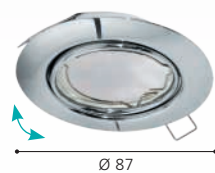

94408 PENETO

recessed light; steel, satin nickel
 Einbauleuchte; Stahl, nickel-matt
 luminaire encastrable; acier, nickel mat

Ø 87, ET 115



GU10 3x 4,6W 3x 400lm Ø 70



9 002759 944087

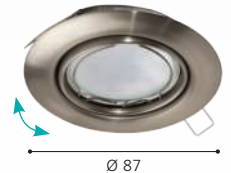

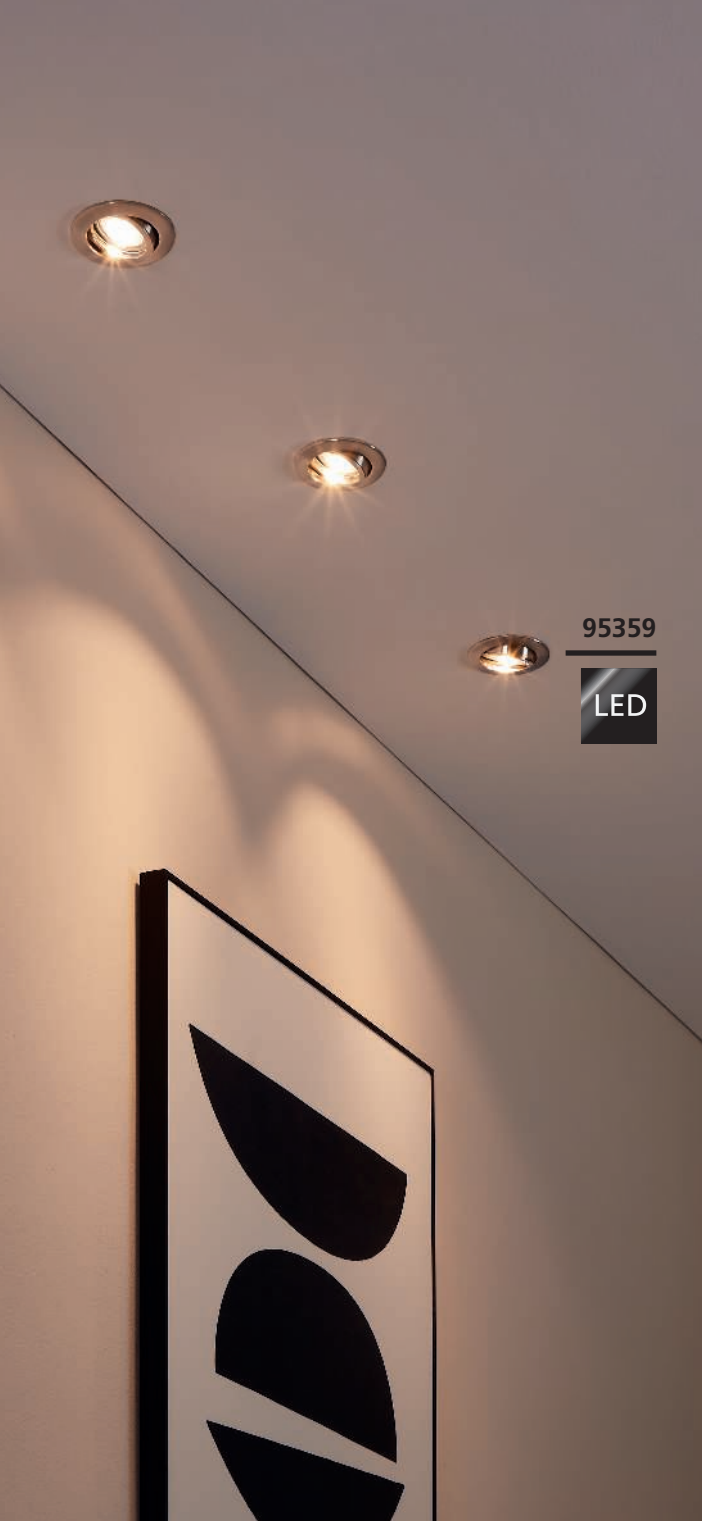

95359

LED



31683

LED



31689

LED

31683 TEDO

recessed light; cast aluminium, white
 Einbauleuchte; Aluguss, weiss
 luminaire encastrable; fonte d'aluminium, blanc

31689 TEDO

recessed light; cast aluminium, satin nickel
 Einbauleuchte; Aluguss, nickel-matt
 luminaire encastrable; fonte d'aluminium, nickel mat

Ø 80, ET 115



Ø 80, ET 115

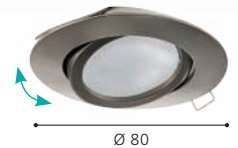
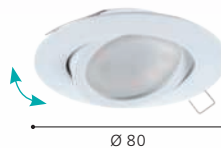



95359

LED

95359 TEDO 1

recessed light; cast aluminium, satin nickel

Einbauleuchte; Aluguss, nickel-matt

luminaire encastrable; fonte d'aluminium, nickel mat

Ø 80, ET 115



GU10



3x 4,8W



warm
WHITE

3x
400lm



Ø68



9 002759 953591



Ø 80

1



2



3



DIMMING WITHOUT A DIMMER?

There's no need for a dimmer anymore, and no need to spend money on an expensive modern LED-capable one.

The luminaire automatically switches to the next dimming level when it is switched off and on again within 3 seconds. If the luminaire stays off for more than 3 seconds, the next activation will automatically return to full lighting. You don't need to switch through all levels the next day.

Note

Our step dimming illuminants are only dimmable via the on/off switch. Operation with a conventional dimmer is not intended and may cause permanent damage to the electronics. The illuminants are therefore marked as "not dimmable" according to European regulations.

DIMMEN OHNE DIMMER?

Kein Dimmer mehr notwendig – Sie ersparen sich somit hohe Anschaffungskosten für einen modernen LED-fähigen Dimmer.

Werden die Leuchten innerhalb von 3 Sekunden aus- und wieder eingeschaltet, wechselt es automatisch in die nächste Dimmstufe. Bleibt die Leuchte länger als 3 Sekunden ausgeschaltet, stehen Ihnen beim nächsten Einschalten automatisch wieder 100 % Leuchtkraft zur Verfügung – Sie ersparen sich also das mühsame Durchschalten am nächsten Tag.

Hinweis

Unsere Stepdimming-Leuchtmittel sind nur über Ein-/Ausshalter dimmbar – der Betrieb mit konventionellen Dimmern ist nicht vorgesehen und könnte die Elektronik dauerhaft beschädigen. Die Leuchtmittel werden daher gemäß europäischer Vorschriften als „nicht dimmbar“ gekennzeichnet.

GRADUER SANS GRADUATEUR ?

Aucun graduateur n'est nécessaire – Vous vous épargnez ainsi les coûts d'acquisition élevés pour un graduateur DEL moderne.

Si les luminaires sont éteints puis rallumés en l'espace de 3 secondes, il passe automatiquement au niveau de gradation suivant. Si le luminaire reste éteint pendant plus de 3 secondes, vous disposez à nouveau automatiquement de 100 % d'intensité lumineuse lors du prochain allumage - vous vous épargnez ainsi la tâche fastidieuse d'allumer le luminaire le lendemain.

Remarque

Nos ampoules à gradation par niveau sont graduables uniquement par l'interrupteur marche / arrêt – le service avec un graduateur conventionnel n'est pas prévu et pourrait endommager l'électronique à long terme. Les ampoules sont alors marquées par « non graduable », selon les réglementations européenne.

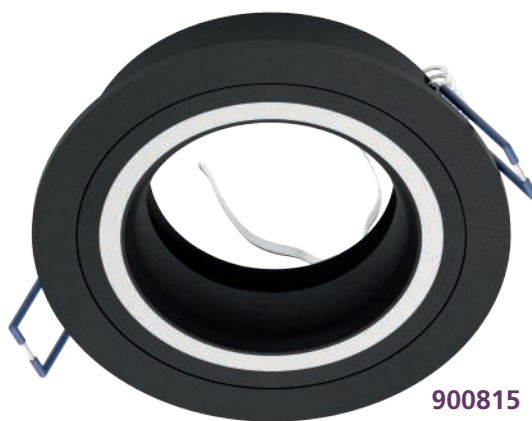

900815 CAROSSO

recessed light; aluminium, black, white
Einbauleuchte; Alu, schwarz, weiss
luminaire encastrable; aluminium, noir, blanc

H 28, Ø 93



GU10



1x 35W



Ø80



9 008606 259236



Ø 93



900816



900454

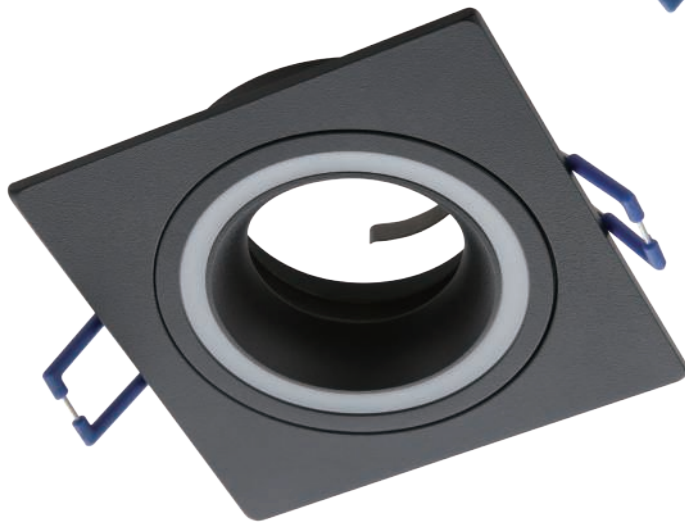

900451

900451 CAROSSO

recessed light; aluminium, black / plastic, white
 Einbauleuchte; Alu, schwarz / Kunststoff, weiss
 luminaire encastrable; aluminium, noir / plastique, blanc

L 93, B 93, H 25



GU10 1x 35W Ø80

900816 CAROSSO

recessed light; aluminium, white
 Einbauleuchte; Alu, weiss
 luminaire encastrable; aluminium, blanc

H 28, Ø 93



GU10 1x 35W Ø80

900454 CAROSSO

recessed light; aluminium, white / plastic, white
 Einbauleuchte; Alu, weiss / Kunststoff, weiss
 luminaire encastrable; aluminium, blanc / plastique, blanc

L 93, B 93, H 25



GU10 1x 35W Ø80



9 008606 238767

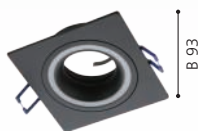

L 93



9 008606 259243



Ø 93



9 008606 238798

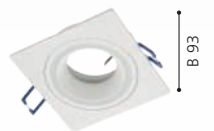

L 93



900453 CAROSSO

recessed light; aluminium, black, white
 Einbauleuchte; Alu, schwarz, weiss
 luminaire encastrable; aluminium, noir, blanc

H 35, Ø 93



GU10 1x 35W Ø68



Ø 93

900452 CAROSSO

recessed light; aluminium, black, white
 Einbauleuchte; Alu, schwarz, weiss
 luminaire encastrable; aluminium, noir, blanc

L 93, B 93, H 25



GU10 1x 35W Ø68

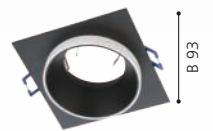

L 93



900456 CAROSSO

recessed light; aluminium, white, black
 Einbauleuchte; Alu, weiss, schwarz
 luminaire encastrable; aluminium, blanc, noir

H 35, Ø 93



900455 CAROSSO

recessed light; aluminium, white, black
 Einbauleuchte; Alu, weiss, schwarz
 luminaire encastrable; aluminium, blanc, noir

L 93, B 93, H 25

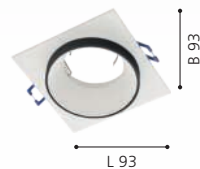

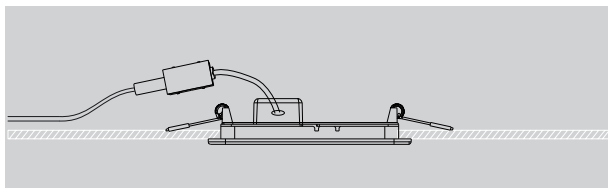

RECESSED DOWNLIGHTS

FUEVA

ADVANTAGES

- > MODERN APPEARANCE - THE FUEVA CONVINCES WITH ITS FLAT DESIGN AND NARROW FRAME
 - > AVAILABLE IN DIFFERENT VARIATIONS (MATERIAL & COLOUR, SHAPE, IP CLASS)
 - > INCLUSIVE PLUG-IN TERMINAL - FOR QUICK WORK AND EASY HANDLING
-

VORTEILE

- > MODERNES ERSCHEINUNGSBILD - DIE FUEVA ÜBERZEUGT DURCH IHR FLACHES DESIGN SOWIE DEN SCHMALEN RAHMEN
 - > ERHÄLTlich IN VERSCHIEDENEN VARIATIONEN (FARBE, FORM, IP KLASSE)
 - > INKLUSIVE STECKKLEMME - FÜR DAS SCHNELLE ARBEITEN UND EINE EINFACHE HANDHABUNG
-

AVANTAGES

- > APPARENCE MODERNE - LE FUEVA CONVAINC PAR SON DESIGN PLAT ET SON CADRE ÉTROIT
- > DISPONIBLE EN DIFFÉRENTES VARIATIONS (COULEUR, FORME, CLASSE IP)
- > Y COMPRIS UNE BORNE ENFICHABLE - POUR UN TRAVAIL RAPIDE ET UNE MANIPULATION SIMPLE

OVERVIEW



FUEVA 5
241-251



FUEVA-A
242



FUEVA 1
252



FUEVA FLEX
255



This product is available in different colors and shapes./ Dieser Artikel ist in unterschiedlichen Farben und Formen verfügbar./
Cet article est disponible en différentes couleurs et formes.



IP44



FUEVA 5

Water-splash protected luminaires are labelled with an IP value.

Spritzwassergeschützte Leuchten sind mittels IP-Wert gekennzeichnet.

Les luminaires protégés contre les projections d'eau sont identifiés au moyen de la valeur IP.

	0	1	2	3
EU	X	X	✓	✓
FR	X	X	X	✓





































FUEVA 5

Ø 86, ET 26

recessed light
Einbauleuchte
luminaire encastrable



Material / Colour	Size	Cutout	Quantity	Watt	Lumen	IP class	Item no.	EAN code
 steel, white / plastic, white Stahl, weiss / Kunststoff, weiss acier, blanc / plastique, blanc	Ø 86, ET 26	Ø 75		2,7W	 330lm		99131	9 002759 991319
	Ø 86, ET 26	Ø 75	3	3 x 2,7W	 990lm		99135	9 002759 991357
	Ø 86, ET 26	Ø 75		2,7W	 330lm	 IP44	99202	9 002759 992026
	Ø 86, ET 26	Ø 75		2,7W	 330lm		99147	9 002759 991470
	Ø 86, ET 26	Ø 75		2,7W	 330lm	 IP44	99206	9 002759 992064
 steel, satin nickel / plastic, white Stahl, nickel-matt / Kunststoff, weiss acier, nickel mat / plastique, blanc	Ø 86, ET 26	Ø 75		2,7W	 330lm		99136	9 002759 991364
	Ø 86, ET 26	Ø 75	3	3 x 2,7W	 990lm		99141	9 002759 991418
	Ø 86, ET 26	Ø 75		2,7W	 330lm		99152	9 002759 991524
 steel, chrome / plastic, white Stahl, chrom / Kunststoff, weiss acier, chrome / plastique, blanc	Ø 86, ET 26	Ø 75		2,7W	 330lm	 IP44	99204	9 002759 992040
	Ø 86, ET 26	Ø 75		2,7W	 330lm	 IP44	99208	9 002759 992088
 steel, black / plastic, white Stahl, schwarz / Kunststoff, weiss acier, noir / plastique, blanc	Ø 86, ET 26	Ø 75		2,7W	 330lm		99142	9 002759 991425
	Ø 86, ET 26	Ø 75	3	3 x 2,7W	 990lm		99146	9 002759 991463
	Ø 86, ET 26	Ø 75		2,7W	 330lm	 IP44	99211	9 002759 992118
	Ø 86, ET 26	Ø 75		2,7W	 330lm		99156	9 002759 991562
	Ø 86, ET 26	Ø 75		2,7W	 330lm	 IP44	99213	9 002759 992132



FUEVA 5

Ø 117, ET 26

recessed light
Einbauleuchte
luminaire encastrable

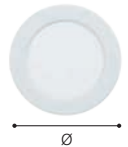

Material / Colour	Size	Cutout	Watt	Lumen	Item no.	EAN code
steel, white / plastic, white Stahl, weiss / Kunststoff, weiss acier, blanc / plastique, blanc	Ø 117, ET 26	Ø 105	5,5W	warm WHITE 650lm		99132 9 002759 991326
	Ø 117, ET 26	Ø 105	5,5W	warm WHITE 650lm		99191 9 002759 991913
	Ø 117, ET 26	Ø 105	5,5W	neutral WHITE 700lm		99148 9 002759 991487
steel, satin nickel / plastic, white Stahl, nickel-matt / Kunststoff, weiss acier, nickel mat / plastique, blanc	Ø 117, ET 26	Ø 105	5,5W	warm WHITE 650lm		99137 9 002759 991371
	Ø 117, ET 26	Ø 105	5,5W	neutral WHITE 700lm		99153 9 002759 991531
steel, black / plastic, white Stahl, schwarz / Kunststoff, weiss acier, noir / plastique, blanc	Ø 117, ET 26	Ø 105	5,5W	warm WHITE 650lm		99143 9 002759 991432
	Ø 117, ET 26	Ø 105	5,5W	neutral WHITE 700lm		99157 9 002759 991579



FUEVA-A

Ø 120, ET 30

recessed light
Einbauleuchte
luminaire encastrable

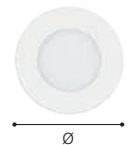

Material / Colour	Size	Cutout	Watt	Lumen	Item no.	EAN code
aluminium, white / plastic, white Alu, weiss / Kunststoff, weiss aluminium, blanc / plastique, blanc	Ø 120, ET 30	Ø 108	5W	tunable WHITE 700lm	Remote CONTROL UNIT	98212 9 002759 982126





IP44



FUEVA 5

Water-splash protected luminaires are labelled with an IP value.

Spritzwassergeschützte Leuchten sind mittels IP-Wert gekennzeichnet.

Les luminaires protégés contre les projections d'eau sont identifiés au moyen de la valeur IP.









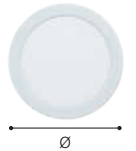



























	0	1	2	3
EU	X	X	✓	✓
FR	X	X	X	✓



FUEVA 5
Ø 166, ET 26

recessed light
Einbauleuchte
luminaire encastrable



















Material / Colour	Size	Cutout	Watt	Lumen	IP class	Item no.	EAN code
 steel, white / plastic, white Stahl, weiss / Kunststoff, weiss acier, blanc / plastique, blanc	Ø 166, ET 26	Ø 155	11 W	 warm WHITE 1350 lm		99133	9 002759 991333
	Ø 166, ET 26	Ø 155	11 W	 warm WHITE 1350 lm		99192	9 002759 991920
	Ø 166, ET 26	Ø 155	11 W	 warm WHITE 1350 lm	  IP44	99203	9 002759 992033
	Ø 166, ET 26	Ø 155	11 W	 neutral WHITE 1350 lm		99149	9 002759 991494
	Ø 166, ET 26	Ø 155	11 W	 neutral WHITE 1350 lm	  IP44	99207	9 002759 992071
 steel, satin nickel / plastic, white Stahl, nickel-matt / Kunststoff, weiss acier, nickel mat / plastique, blanc	Ø 166, ET 26	Ø 155	11 W	 warm WHITE 1350 lm		99138	9 002759 991388
	Ø 166, ET 26	Ø 155	11 W	 neutral WHITE 1350 lm		99154	9 002759 991548
 steel, chrome / plastic, white Stahl, chrom / Kunststoff, weiss acier, chrome / plastique, blanc	Ø 166, ET 26	Ø 155	11 W	 warm WHITE 1350 lm	  IP44	99205	9 002759 992057
	Ø 166, ET 26	Ø 155	11 W	 neutral WHITE 1350 lm	  IP44	99209	9 002759 992095
 steel, black / plastic, white Stahl, schwarz / Kunststoff, weiss acier, noir / plastique, blanc	Ø 166, ET 26	Ø 155	11 W	 warm WHITE 1350 lm		99144	9 002759 991449
	Ø 166, ET 26	Ø 155	11 W	 warm WHITE 1350 lm	  IP44	99212	9 002759 992125
	Ø 166, ET 26	Ø 155	11 W	 neutral WHITE 1350 lm		99158	9 002759 991586
	Ø 166, ET 26	Ø 155	11 W	 neutral WHITE 1350 lm	  IP44	99214	9 002759 992149



FUEVA 5
Ø 216, ET 26

recessed light
Einbauleuchte
luminaire encastrable



Material / Colour	Size	Cutout	Watt		Lumen		Item no.	EAN code
 steel, white / plastic, white Stahl, weiss / Kunststoff, weiss acier, blanc / plastique, blanc	Ø 216, ET 26	Ø 205	17W		2000lm		99134	9 002759 991340
	Ø 216, ET 26	Ø 205	17W		2000lm		99193	9 002759 991937
	Ø 216, ET 26	Ø 205	17W		2100lm		99151	9 002759 991517
 steel, satin nickel / plastic, white Stahl, nickel-matt / Kunststoff, weiss acier, nickel mat / plastique, blanc	Ø 216, ET 26	Ø 205	17W		2000lm		99139	9 002759 991395
	Ø 216, ET 26	Ø 205	17W		2100lm		99155	9 002759 991555
 steel, black / plastic, white Stahl, schwarz / Kunststoff, weiss acier, noir / plastique, blanc	Ø 216, ET 26	Ø 205	17W		2000lm		99145	9 002759 991456
	Ø 216, ET 26	Ø 205	17W		2100lm		99159	9 002759 991593



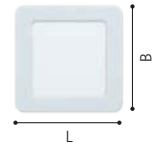

FUEVA 5

L 117, B 117, ET 26

recessed light
Einbauleuchte
luminaire encastrable



Material / Colour	Size	Cutout	Watt	Lumen	Item no.	EAN code
steel, white / plastic, white Stahl, weiss / Kunststoff, weiss acier, blanc / plastique, blanc	L 117, B 117, ET 26	105 x 105	5,5W	650lm	99162	9 002759 991623
	L 117, B 117, ET 26	105 x 105	5,5W	700lm	99178	9 002759 991784
steel, satin nickel / plastic, white Stahl, nickel-matt / Kunststoff, weiss acier, nickel mat / plastique, blanc	L 117, B 117, ET 26	105 x 105	5,5W	650lm	99167	9 002759 991678
	L 117, B 117, ET 26	105 x 105	5,5W	700lm	99183	9 002759 991838
steel, black / plastic, white Stahl, schwarz / Kunststoff, weiss acier, noir / plastique, blanc	L 117, B 117, ET 26	105 x 105	5,5W	700lm	99187	9 002759 991876

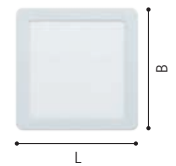
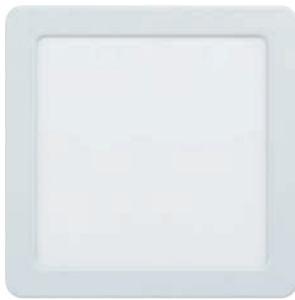

FUEVA 5

L 166, B 166, ET 26

recessed light
Einbauleuchte
luminaire encastrable



Material / Colour	Size	Cutout	Watt	Lumen	Item no.	EAN code
steel, white / plastic, white Stahl, weiss / Kunststoff, weiss acier, blanc / plastique, blanc	L 166, B 166, ET 26	155 x 155	11 W	1350lm	99163	9 002759 991630
	L 166, B 166, ET 26	155 x 155	11 W	1350lm	99179	9 002759 991791
steel, satin nickel / plastic, white Stahl, nickel-matt / Kunststoff, weiss acier, nickel mat / plastique, blanc	L 166, B 166, ET 26	155 x 155	11 W	1350lm	99168	9 002759 991685
	L 166, B 166, ET 26	155 x 155	11 W	1350lm	99184	9 002759 991845
steel, black / plastic, white Stahl, schwarz / Kunststoff, weiss acier, noir / plastique, blanc	L 166, B 166, ET 26	155 x 155	11 W	1350lm	99188	9 002759 991883





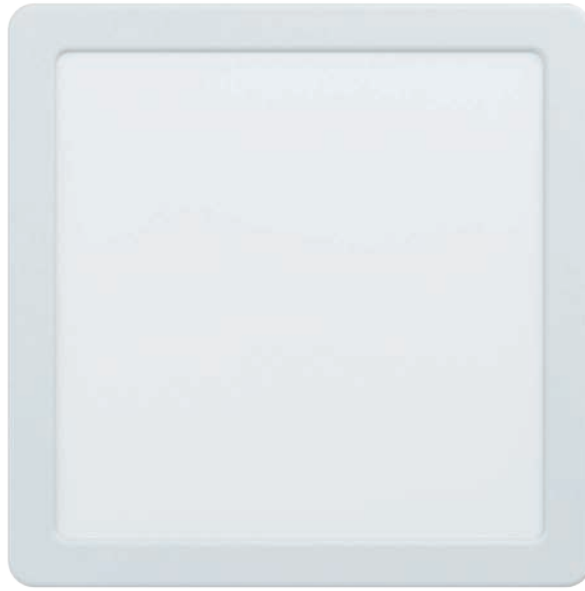







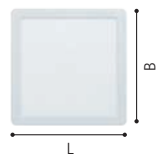







FUEVA 5

L 216, B 216, ET 26

recessed light
Einbauleuchte
luminaire encastrable



Material / Colour	Size	Cutout	Watt		Lumen		Item no.	EAN code
 steel, white / plastic, white Stahl, weiss / Kunststoff, weiss acier, blanc / plastique, blanc	L 216, B 216, ET 26	205 x 205	17W	 warm WHITE	2000lm		99164	9 002759 991647
	L 216, B 216, ET 26	205 x 205	17W	 neutral WHITE	2100lm		99181	9 002759 991814
 steel, satin nickel / plastic, white Stahl, nickel-matt / Kunststoff, weiss acier, nickel mat / plastique, blanc	L 216, B 216, ET 26	205 x 205	17W	 warm WHITE	2000lm		99169	9 002759 991692
	L 216, B 216, ET 26	205 x 205	17W	 neutral WHITE	2100lm		99185	9 002759 991852
 steel, black / plastic, white Stahl, schwarz / Kunststoff, weiss acier, noir / plastique, blanc	L 216, B 216, ET 26	205 x 205	17W	 neutral WHITE	2100lm		99189	9 002759 991890

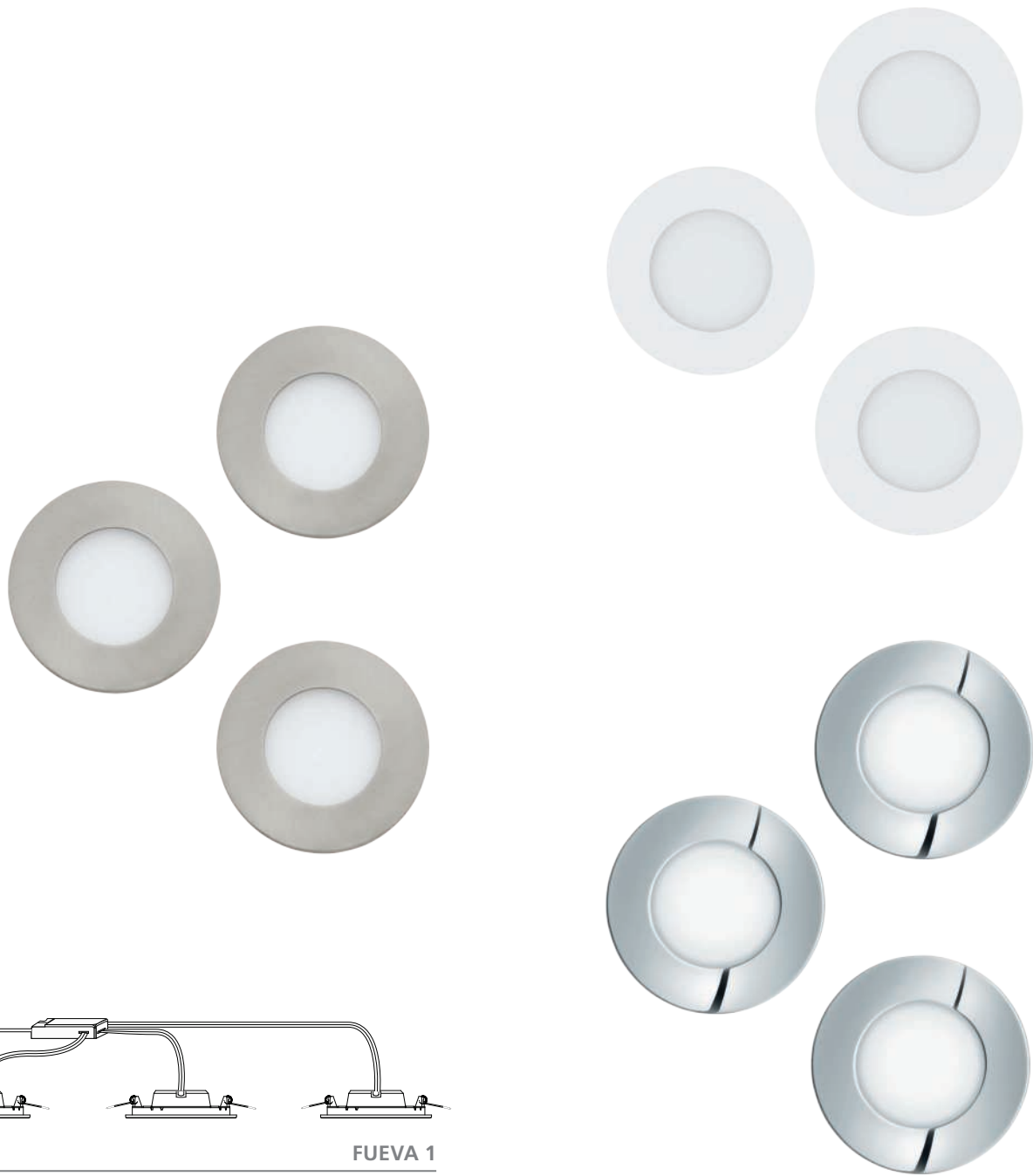

FUEVA 1

3 spots with only one driver.

3 Spots nur mit einen Treiber.













3 places avec un seul conducteur.

FUEVA 1

Ø 85, ET 30

recessed light
Einbauleuchte
luminaire encastrable



Material / Colour	Size	Cutout	Quantity	Watt	Lumen	IP class	Item no.	EAN code
 cast metal, white / plastic, white Metallguss, weiss / Kunststoff, weiss fonte métallique, blanc / plastique, blanc	Ø 85, ET 30	Ø 74	3	3 x 2,8W	 1050lm	  IP20/44	98633	9 002759 986339
 cast metal, satin nickel / plastic, white Metallguss, nickel-matt / Kunststoff, weiss fonte métallique, nickel mat / plastique, blanc	Ø 85, ET 30	Ø 74	3	3 x 2,8W	 1050lm	  IP20/44	98634	9 002759 986346
 cast metal, chrome / plastic, white Metallguss, chrom / Kunststoff, weiss fonte métallique, chrome / plastique, blanc	Ø 85, ET 30	Ø 74	3	3 x 2,8W	 1050lm	  IP20/44	98635	9 002759 986353



IP44



FUEVA 1

Water-splash protected luminaires are labelled with an IP value.

Spritzwassergeschützte Leuchten sind mittels IP-Wert gekennzeichnet.

Les luminaires protégés contre les projections d'eau sont identifiés au moyen de la valeur IP.

	0	1	2	3
EU	X	X	✓	✓
FR	X	X	X	✓



FUEVA FLEX

Flexible mounting bracket for various ceiling cut-outs from 68-100 mm.

Flexibler Einbaubügel für verschiedene Deckenausschnitte von 68-100 mm.

Support de montage flexible pour différentes découpes de plafond de 68 à 100 mm.

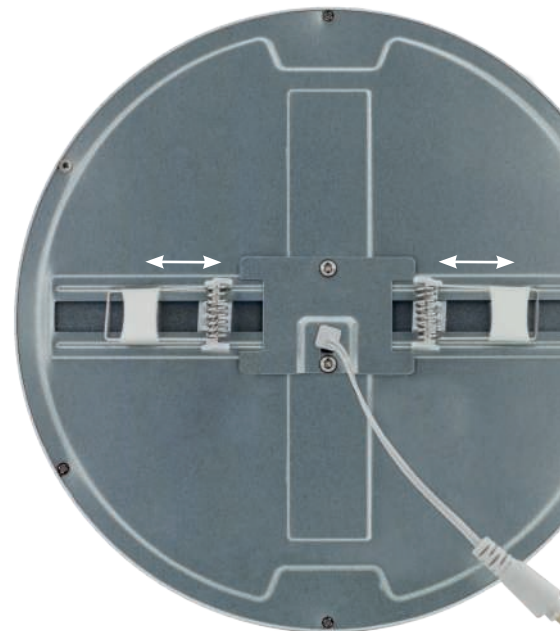

FUEVA FLEX

Flexible mounting bracket for various ceiling cut-outs from 70-200 mm.

Flexibler Einbaubügel für verschiedene Deckenausschnitte von 70-200 mm.

Support de montage flexible pour différentes découpes de plafond de 70 à 200 mm.

















FUEVA FLEX

H 2, Ø 117

recessed light
Einbauleuchte
luminaire encastrable



Material / Colour	Size	Cutout	Watt		Lumen		Item no.	EAN code
 aluminium, white / plastic, white Alu, weiss / Kunststoff, weiss aluminium, blanc / plastique, blanc	H 2, Ø 117	Ø 68-100	5,5W		650lm		900932	9 008606 277735
	H 2, Ø 117	Ø 68-100	5,5W		700lm		900935	9 008606 277766
 aluminium, satin nickel / plastic, white Alu, nickel-matt / Kunststoff, weiss aluminium, nickel mat / plastique, blanc	H 2, Ø 117	Ø 68-100	5,5W		650lm		900933	9 008606 277742
	H 2, Ø 117	Ø 68-100	5,5W		700lm		900936	9 008606 277773
 aluminium, black / plastic, white Alu, schwarz / Kunststoff, weiss aluminium, noir / plastique, blanc	H 2, Ø 117	Ø 68-100	5,5W		650lm		900931	9 008606 277728
	H 2, Ø 117	Ø 68-100	5,5W		700lm		900934	9 008606 277759









FUEVA FLEX

H 25, Ø 225

recessed light
Einbauleuchte
luminaire encastrable



Material / Colour	Size	Cutout	Watt		Lumen		Item no.	EAN code
 aluminium, white / plastic, white Alu, weiss / Kunststoff, weiss aluminium, blanc / plastique, blanc	H 25, Ø 225	Ø 70-200	22W		2800lm		98865	9 002759 988654
	H 25, Ø 225	Ø 70-200	22W		2800lm		98868	9 002759 988685
 aluminium, satin nickel / plastic, white Alu, nickel-matt / Kunststoff, weiss aluminium, nickel mat / plastique, blanc	H 25, Ø 225	Ø 70-200	22W		2800lm		98866	9 002759 988661
	H 25, Ø 225	Ø 70-200	22W		2800lm		98869	9 002759 988692
 aluminium, black / plastic, white Alu, schwarz / Kunststoff, weiss aluminium, noir / plastique, blanc	H 25, Ø 225	Ø 70-200	22W		2800lm		98867	9 002759 988678
	H 25, Ø 225	Ø 70-200	22W		2800lm		98871	9 002759 988715



SURFACE DOWNLIGHTS

ADVANTAGES

- > DISCREET IN APPEARANCE, PERFECT IN STAGING
 - > SET THE SCENE IN YOUR HOME
 - > IMPRESS WITH THEIR UNCOMPLICATED APPLICATION
 - > ARE ENERGY AND COST-SAVING THANKS TO THE LED CIRCUIT BOARDS AND LED LIGHT SOURCES
-

VORTEILE

- > DEZENT IM AUFTRETEN, PERFEKT IN DER INSZENIERUNG
 - > SETZEN IHR ZUHAUSE IN SZENE
 - > ÜBERZEUGEN MIT IHRER UNKOMPLIZIERTEN ANWENDUNG
 - > SIND AUFGRUND DER LED-PLATINEN UND LED-LEUCHTMITTEL STROM- UND KOSTENSPAREND
-

AVANTAGES

AVANTAGES

- > DISCRET DANS SON APPARENCE, PARFAIT DANS SA MISE EN SCÈNE
- > METTENT VOTRE MAISON EN SCÈNE
- > CONVAINQUENT PAR LEUR SIMPLICITÉ D'UTILISATION
- > SONT ÉCONOMES EN ÉNERGIE ET EN COÛTS GRÂCE AUX PLATINES LED ET AUX SOURCES LUMINEUSES LED



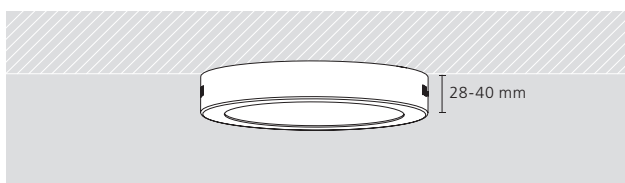

SURFACE DOWNLIGHTS

FUEVA

ADVANTAGES

- > SLIM DESIGN WITH LOW SURFACE HEIGHT (28 TO 40 MM)
- > AVAILABLE IN VARIOUS MATERIAL & COLOURS, SHAPES AND IP CLASSES.
- > LOW TEMPERATURE ENHANCES SAFETY
- > UP TO 80% POWER SAVINGS COMPARED TO INCANDESCENT LAMPS, EASY ON YOUR BUDGET AND THE ENVIRONMENT

VORTEILE

- > SCHLANKE BAUFORM MIT GERINGER AUFBAUHÖHE (28 BIS 40 MM)
- > ERHÄLTlich IN VERSCHIEDENEN FARBEN, FORMEN UND IP-KLASSEN.
- > GERINGE WÄRMEENTWICKLUNG SORGT FÜR MEHR SICHERHEIT
- > BIS ZU 80% STROMERSPARNIS GEGENÜBER GLÜHLAMPEN, SCHONT IHR BUDGET UND DIE UMWELT

AVANTAGES

- > CONCEPTION MINCE AVEC LA HAUTEUR DE SAILIE MINIMALE (DE 28 À 40 MM)
- > DISPONIBLE EN DIFFÉRENTES COULEURS, FORMES ET CLASSES IP.
- > FAIBLE CHALEUR AMÉLIORE LA SÉCURITÉ
- > JUSQU'À 80% D'ÉCONOMIES D'ÉNERGIE PAR RAPPORT AUX LAMPES À INCANDESCENCE, RÉDUIT VOTRE BUDGET ET PROTÈGE L'ENVIRONNEMENT

OVERVIEW



FUEVA-A
260



FUEVA 5
263-272



FUEVA 1
274



This product is available in different colors and shapes./ Dieser Artikel ist in unterschiedlichen Farben und Formen verfügbar./
Cet article est disponible en différentes couleurs et formes.



FUEVA-A

H 30, Ø 225

surface-mounted light
Aufbauleuchte
luminaire en saillie



incl./inkl./inclus



Material / Colour	Size	Watt	Lumen	Item no.	EAN code
<ul style="list-style-type: none"> aluminium, white / plastic, white Alu, weiss / Kunststoff, weiss aluminium, blanc / plastique, blanc 	H 30, Ø 225	14 W	2000lm	Remote	98292 9 002759 982928

FUEVA-A

H 30, Ø 300

surface-mounted light
Aufbauleuchte
luminaire en saillie



incl./inkl./inclus



Material / Colour	Size	Watt	Lumen	Item no.	EAN code
<ul style="list-style-type: none"> aluminium, white / plastic, white Alu, weiss / Kunststoff, weiss aluminium, blanc / plastique, blanc 	H 30, Ø 300	20 W	2650lm	Remote	98293 9 002759 982935





IP44



FUEVA 5

Water-splash protected luminaires are labelled with an IP value.

Spritzwassergeschützte Leuchten sind mittels IP-Wert gekennzeichnet.

Les luminaires protégés contre les projections d'eau sont identifiés au moyen de la valeur IP.

	0	1	2	3
EU	X	X	✓	✓
FR	X	X	X	✓



FUEVA 5

H 28, Ø 160

surface-mounted light
Aufbauleuchte
luminaire en saillie

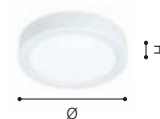

Material / Colour	Size	Watt	Lumen	IP class	Item no.	EAN code
steel, white / plastic, white Stahl, weiss / Kunststoff, weiss acier, blanc / plastique, blanc	H 28, Ø 160	11 W	1350lm		99215	9 002759 992156
	H 28, Ø 160	11 W	1350lm		900582	9 008606 244829
	H 28, Ø 160	11 W	1350lm	IP44	900638	9 008606 245222
	H 28, Ø 160	11 W	1350lm		99225	9 002759 992255
steel, satin nickel / plastic, white Stahl, nickel-matt / Kunststoff, weiss acier, nickel mat / plastique, blanc	H 28, Ø 160	11 W	1350lm		99218	9 002759 992187
	H 28, Ø 160	11 W	1350lm		900583	9 008606 244836
	H 28, Ø 160	11 W	1350lm		99228	9 002759 992286
steel, chrome / plastic, white Stahl, chrom / Kunststoff, weiss acier, chrome / plastique, blanc	H 28, Ø 160	11 W	1350lm	IP44	900639	9 008606 245239
steel, black / plastic, white Stahl, schwarz / Kunststoff, weiss acier, noir / plastique, blanc	H 28, Ø 160	11 W	1350lm		99222	9 002759 992224
	H 28, Ø 160	11 W	1350lm		900581	9 008606 244812
	H 28, Ø 160	11 W	1350lm	IP44	900637	9 008606 245215
	H 28, Ø 160	11 W	1350lm		99233	9 002759 992330



FUEVA 5

H 28, Ø 210

surface-mounted light
Aufbauleuchte
luminaire en saillie



Material / Colour	Size	Watt	Lumen	IP class	Sensor	Item no.	EAN code	
steel, white / plastic, white Stahl, weiss / Kunststoff, weiss acier, blanc / plastique, blanc	H 28, Ø 210	17W	2000lm			99216	9 002759 992163	
	H 28, Ø 210	17W	2000lm			99258	9 002759 992583	
	H 28, Ø 210	17W	2000lm				900654	9 008606 245369
	H 28, Ø 210	17W	2000lm			160°, 2 m 20 sec.	901011	9 008606 299508
	H 28, Ø 210	17W	2100lm				99226	9 002759 992262
steel, satin nickel / plastic, white Stahl, nickel-matt / Kunststoff, weiss acier, nickel mat / plastique, blanc	H 28, Ø 210	17W	2000lm			99219	9 002759 992194	
	H 28, Ø 210	17W	2000lm			900584	9 008606 244843	
	H 28, Ø 210	17W	2100lm				99229	9 002759 992293
steel, chrome / plastic, white Stahl, chrom / Kunststoff, weiss acier, chrome / plastique, blanc	H 28, Ø 210	17W	2000lm				900641	9 008606 245246
steel, black / plastic, white Stahl, schwarz / Kunststoff, weiss acier, noir / plastique, blanc	H 28, Ø 210	17W	2000lm			99223	9 002759 992231	
	H 28, Ø 210	17W	2000lm			99263	9 002759 992637	
	H 28, Ø 210	17W	2000lm				900653	9 008606 245352
	H 28, Ø 210	17W	2000lm			160°, 2 m 20 sec.	901013	9 008606 299522
	H 28, Ø 210	17W	2100lm				99234	9 002759 992347
steel, brushed brass / plastic, white Stahl, messing-gebürstet / Kunststoff, weiss acier, laiton brossé / plastique, blanc	H 28, Ø 210	17W	2000lm				900181	9 008606 229567



FUEVA 5

H 28, Ø 285

surface-mounted light
Aufbauleuchte
luminaire en saillie



Material / Colour	Size	Watt	Lumen	IP class	Sensor	Item no.	EAN code	
steel, white / plastic, white Stahl, weiss / Kunststoff, weiss acier, blanc / plastique, blanc	H 28, Ø 285	20,5W	warm WHITE 2400lm			99217	9 002759 992170	
	H 28, Ø 285	20,5W	warm WHITE 2400lm			99259	9 002759 992590	
	H 28, Ø 285	20,5W	warm WHITE 2400lm				99265	9 002759 992651
	H 28, Ø 285	20,5W	warm WHITE 2400lm			160°, 2 m 20 sec.	901012	9 008606 299515
	H 28, Ø 285	20,5W	neutral WHITE 2500lm				99227	9 002759 992279
	H 28, Ø 285	20,5W	neutral WHITE 2500lm				30891	9 002759 308919
steel, satin nickel / plastic, white Stahl, nickel-matt / Kunststoff, weiss acier, nickel mat / plastique, blanc	H 28, Ø 285	20,5W	warm WHITE 2400lm			99221	9 002759 992217	
	H 28, Ø 285	20,5W	warm WHITE 2400lm			900585	9 008606 244850	
	H 28, Ø 285	20,5W	neutral WHITE 2500lm				99232	9 002759 992323
steel, chrome / plastic, white Stahl, chrom / Kunststoff, weiss acier, chrome / plastique, blanc	H 28, Ø 285	20,5W	warm WHITE 2400lm			99266	9 002759 992668	
	H 28, Ø 285	20,5W	neutral WHITE 2500lm			30892	9 002759 308926	
steel, black / plastic, white Stahl, schwarz / Kunststoff, weiss acier, noir / plastique, blanc	H 28, Ø 285	20,5W	warm WHITE 2400lm			99224	9 002759 992248	
	H 28, Ø 285	20,5W	warm WHITE 2400lm			99264	9 002759 992644	
	H 28, Ø 285	20,5W	warm WHITE 2400lm				99267	9 002759 992675
	H 28, Ø 285	20,5W	warm WHITE 2400lm			160°, 2 m 20 sec.	901014	9 008606 299539
	H 28, Ø 285	20,5W	neutral WHITE 2500lm				99235	9 002759 992354
	H 28, Ø 285	20,5W	neutral WHITE 2500lm				30761	9 002759 307615
steel, brushed brass / plastic, white Stahl, messing-gebürstet / Kunststoff, weiss acier, laiton brossé / plastique, blanc	H 28, Ø 285	20,5W	warm WHITE 2400lm			900182	9 008606 229574	



IP44



FUEVA 5

Water-splash protected luminaires are labelled with an IP value.

Spritzwassergeschützte Leuchten sind mittels IP-Wert gekennzeichnet.

Les luminaires protégés contre les projections d'eau sont identifiés au moyen de la valeur IP.

	0	1	2	3
EU	X	X	✓	✓
FR	X	X	X	✓



FUEVA 5

L 160, B 160, H 28

surface-mounted light
Aufbauleuchte
luminaire en saillie

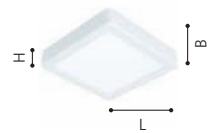

Material / Colour	Size	Watt	Lumen	IP class	Item no.	EAN code
steel, white / plastic, white Stahl, weiss / Kunststoff, weiss acier, blanc / plastique, blanc	L 160, B 160, H 28	11 W	1350lm		99236	9 002759 992361
	L 160, B 160, H 28	11 W	1350lm		900589	9 008606 244898
	L 160, B 160, H 28	11 W	1350lm		900646	9 008606 245291
	L 160, B 160, H 28	11 W	1350lm		99246	9 002759 992460
steel, satin nickel / plastic, white Stahl, nickel-matt / Kunststoff, weiss acier, nickel mat / plastique, blanc	L 160, B 160, H 28	11 W	1350lm		99239	9 002759 992392
	L 160, B 160, H 28	11 W	1350lm		900593	9 008606 244928
	L 160, B 160, H 28	11 W	1350lm		99252	9 002759 992521
steel, chrome / plastic, white Stahl, chrom / Kunststoff, weiss acier, chrome / plastique, blanc	L 160, B 160, H 28	11 W	1350lm		900649	9 008606 245321
steel, black / plastic, white Stahl, schwarz / Kunststoff, weiss acier, noir / plastique, blanc	L 160, B 160, H 28	11 W	1350lm		99243	9 002759 992439
	L 160, B 160, H 28	11 W	1350lm		900586	9 008606 244867
	L 160, B 160, H 28	11 W	1350lm		900643	9 008606 245260
	L 160, B 160, H 28	11 W	1350lm		99255	9 002759 992552





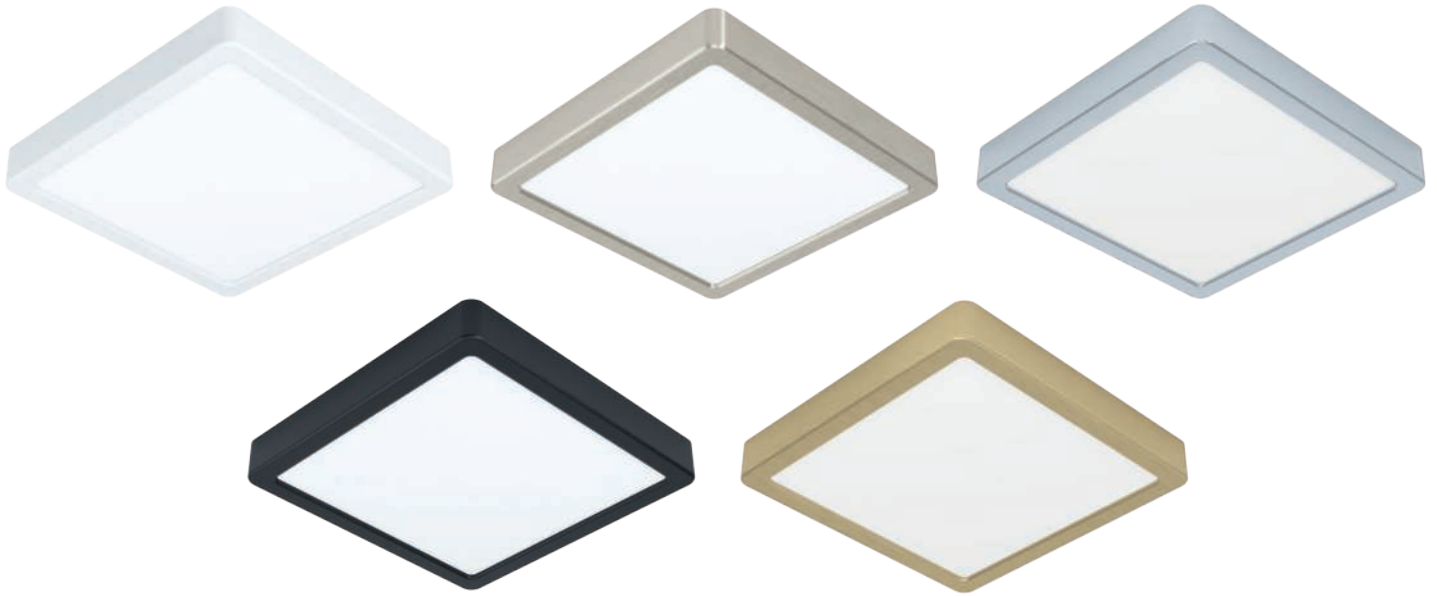





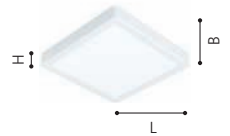





























FUEVA 5
L 210, B 210, H 28

surface-mounted light
Aufbauleuchte
luminaire en saillie



Material / Colour	Size	Watt	Lumen	IP class	Item no.	EAN code
 steel, white / plastic, white Stahl, weiss / Kunststoff, weiss acier, blanc / plastique, blanc	L 210, B 210, H 28	17W	 2000lm		99237	9 002759 992378
	L 210, B 210, H 28	17W	 2000lm		900591	9 008606 244904
	L 210, B 210, H 28	17W	 2000lm	  IP44	900647	9 008606 245307
	L 210, B 210, H 28	17W	 2100lm		99247	9 002759 992477
 steel, satin nickel / plastic, white Stahl, nickel-matt / Kunststoff, weiss acier, nickel mat / plastique, blanc	L 210, B 210, H 28	17W	 2000lm		99241	9 002759 992415
	L 210, B 210, H 28	17W	 2000lm		900594	9 008606 244935
	L 210, B 210, H 28	17W	 2100lm		99253	9 002759 992538
 steel, chrome / plastic, white Stahl, chrom / Kunststoff, weiss acier, chrome / plastique, blanc	L 210, B 210, H 28	17W	 2000lm	  IP44	900651	9 008606 245338
 steel, black / plastic, white Stahl, schwarz / Kunststoff, weiss acier, noir / plastique, blanc	L 210, B 210, H 28	17W	 2000lm		99244	9 002759 992446
	L 210, B 210, H 28	17W	 2000lm		900587	9 008606 244874
	L 210, B 210, H 28	17W	 2000lm	  IP44	900644	9 008606 245277
	L 210, B 210, H 28	17W	 2100lm		99256	9 002759 992569
 steel, brushed brass / plastic, white Stahl, messing-gebürstet / Kunststoff, weiss acier, laiton brossé / plastique, blanc	L 210, B 210, H 28	17W	 2000lm		900183	9 008606 229581

FUEVA 5

L 285, B 285, H 28

surface-mounted light

Aufbauleuchte

luminaire en saillie

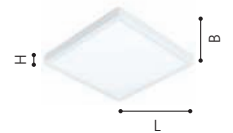

Material / Colour	Size	Watt		Lumen		IP class	Item no.	EAN code
steel, white / plastic, white Stahl, weiss / Kunststoff, weiss acier, blanc / plastique, blanc	L 285, B 285, H 28	20,5W	warm WHITE	2400lm			99238	9 002759 992385
	L 285, B 285, H 30	20,5W	warm WHITE	2400lm		IP44	99268	9 002759 992682
	L 285, B 285, H 28	20,5W	warm WHITE	2400lm			900592	9 008606 244911
	L 285, B 285, H 28	20,5W	neutral WHITE	2500lm			99248	9 002759 992484
	L 285, B 285, H 30	20,5W	neutral WHITE	2500lm		IP44	30893	9 002759 308933
steel, satin nickel / plastic, white Stahl, nickel-matt / Kunststoff, weiss acier, nickel mat / plastique, blanc	L 285, B 285, H 28	20,5W	warm WHITE	2400lm			99242	9 002759 992422
	L 285, B 285, H 28	20,5W	warm WHITE	2400lm			900595	9 008606 244942
	L 285, B 285, H 28	20,5W	neutral WHITE	2500lm			99254	9 002759 992545
steel, chrome / plastic, white Stahl, chrom / Kunststoff, weiss acier, chrome / plastique, blanc	L 285, B 285, H 30	20,5W	warm WHITE	2400lm		IP44	99269	9 002759 992699
	L 285, B 285, H 30	20,5W	neutral WHITE	2500lm		IP44	30894	9 002759 308940
steel, black / plastic, white Stahl, schwarz / Kunststoff, weiss acier, noir / plastique, blanc	L 285, B 285, H 28	20,5W	warm WHITE	2400lm			99245	9 002759 992453
	L 285, B 285, H 30	20,5W	warm WHITE	2400lm		IP44	99271	9 002759 992712
	L 285, B 285, H 28	20,5W	warm WHITE	2400lm			900588	9 008606 244881
	L 285, B 285, H 28	20,5W	neutral WHITE	2500lm			99257	9 002759 992576
	L 285, B 285, H 30	20,5W	neutral WHITE	2500lm		IP44	30762	9 002759 307622
steel, brushed brass / plastic, white Stahl, messing-gebürstet / Kunststoff, weiss acier, laiton brossé / plastique, blanc	L 285, B 285, H 28	20,5W	warm WHITE	2400lm			900184	9 008606 229598



IP44



	0	1	2	3
EU	X	X	✓	✓
FR	X	X	X	✓

FUEVA 5

Water-splash protected luminaires are labelled with an IP value.

Spritzwassergeschützte Leuchten sind mittels IP-Wert gekennzeichnet.

Les luminaires protégés contre les projections d'eau sont identifiés au moyen de la valeur IP.

FUEVA 1

H 30, Ø 400

surface-mounted light
Aufbauleuchte
luminaire en saillie

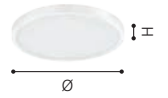

Material / Colour	Size	Watt		Lumen		Item no.	EAN code
aluminium, white / plastic, white Alu, weiss / Kunststoff, weiss aluminium, blanc / plastique, blanc	H 30, Ø 400	22,3W		2500lm		97262	9 002759 972622
	H 30, Ø 400	22,3W		2600lm		97266	9 002759 972660
aluminium, silver / plastic, white Alu, silber / Kunststoff, weiss aluminium, argent / plastique, blanc	H 30, Ø 400	22,3W		2500lm		97263	9 002759 972639
	H 30, Ø 400	22,3W		2600lm		97267	9 002759 972677

FUEVA 1

H 30, Ø 500

surface-mounted light
Aufbauleuchte
luminaire en saillie



Material / Colour	Size	Watt		Lumen		Item no.	EAN code
aluminium, white / plastic, white Alu, weiss / Kunststoff, weiss aluminium, blanc / plastique, blanc	H 30, Ø 500	26W		3000lm		97271	9 002759 972714

FUEVA 1

H 30, Ø 600

surface-mounted light
Aufbauleuchte
luminaire en saillie



Material / Colour	Size	Watt		Lumen		Item no.	EAN code
aluminium, white / plastic, white Alu, weiss / Kunststoff, weiss aluminium, blanc / plastique, blanc	H 30, Ø 600	27W		3400lm		97279	9 002759 972790

FUEVA 1

L 400, B 400, H 30

surface-mounted light
Aufbauleuchte
luminaire en saillie

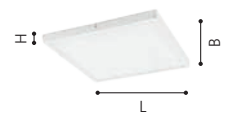

Material / Colour	Size	Watt		Lumen		Item no.	EAN code
aluminium, white / plastic, white Alu, weiss / Kunststoff, weiss aluminium, blanc / plastique, blanc	L 400, B 400, H 30	22W		2500lm		97264	9 002759 972646
	L 400, B 400, H 30	22W		2600lm		97268	9 002759 972684
aluminium, silver / plastic, white Alu, silber / Kunststoff, weiss aluminium, argent / plastique, blanc	L 400, B 400, H 30	22W		2500lm		97265	9 002759 972653
	L 400, B 400, H 30	22W		2600lm		97269	9 002759 972691



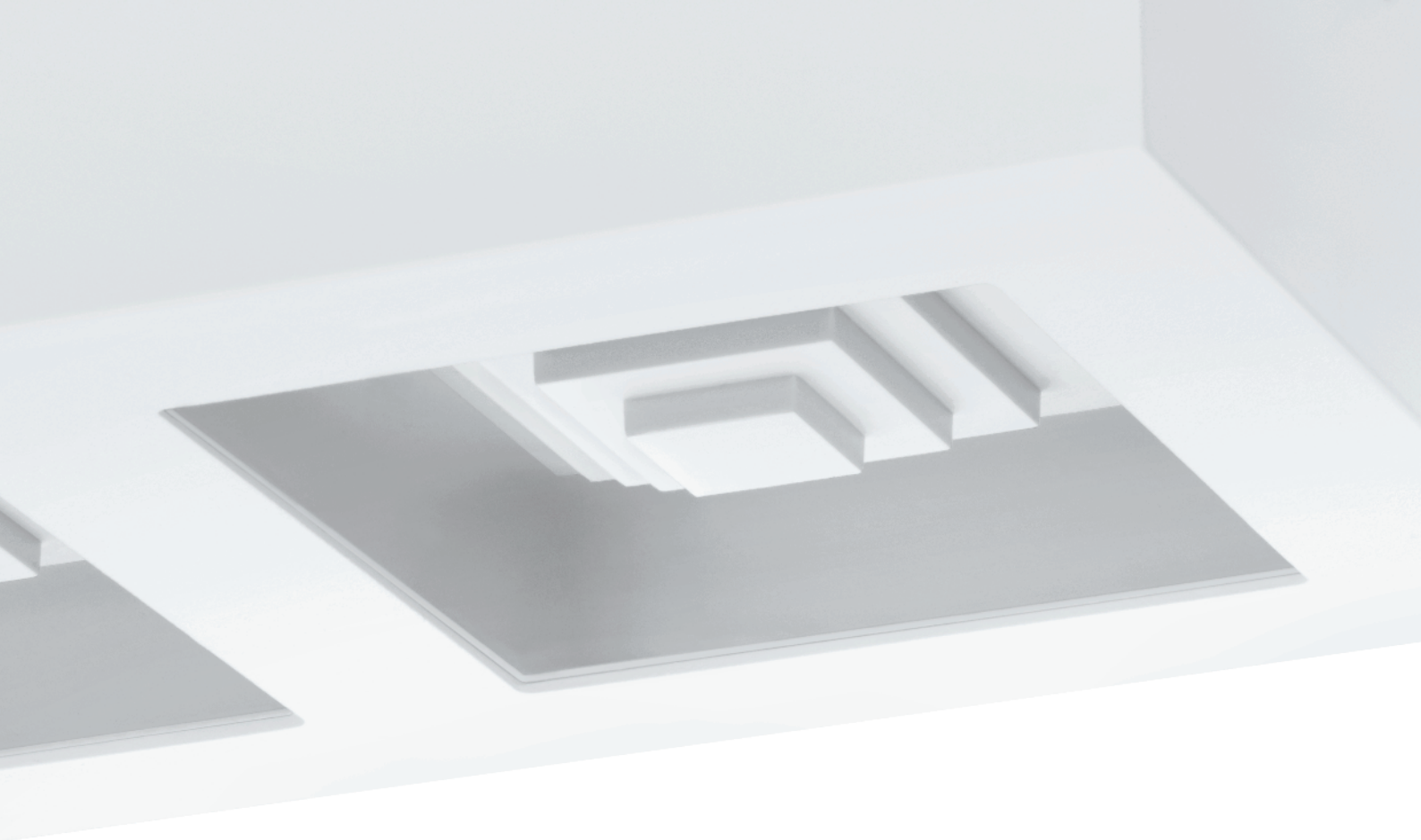

SURFACE DOWNLIGHTS

DECORATIVE

ADVANTAGES

- > UNIFORM DISTRIBUTION OF INDIRECT LIGHT - IDEAL FOR ILLUMINATING SPACES AND SURFACES
 - > LOW TEMPERATURE ENHANCES SAFETY
 - > UP TO 80% POWER SAVINGS COMPARED TO INCANDESCENT LAMPS, EASY ON YOUR BUDGET AND THE ENVIRONMENT
-

VORTEILE

- > HOMOGENES, INDIRECTES LICHT – IDEAL ZUR BELEUCHTUNG VON RÄUMEN UND FLÄCHEN
 - > GERINGE WÄRMEENTWICKLUNG SORGT FÜR MEHR SICHERHEIT
 - > BIS ZU 80% STROMERSPARNIS GEGENÜBER GLÜHLAMPEN, SCHONT IHR BUDGET UND DIE UMWELT
-

AVANTAGES

- > LA DISTRIBUTION UNIFORME DE LA LUMIÈRE INDIRECTE - IDÉAL POUR LES ESPACES ET LES SURFACES ÉCLAIRANTES
- > FAIBLE CHALEUR AMÉLIORE LA SÉCURITÉ
- > JUSQU'À 80% D'ÉCONOMIES D'ÉNERGIE PAR RAPPORT AUX LAMPES À INCANDESCENCE, RÉDUIT VOTRE BUDGET ET PROTÈGE L'ENVIRONNEMENT

OVERVIEW



CRESPILLO
278-279



BOHOYO
280



POLASSO
282-284

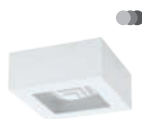

FERREROS
286



This product is available in different colors and shapes./ Dieser Artikel ist in unterschiedlichen Farben und Formen verfügbar./
Cet article est disponible en différentes couleurs et formes.



99726

LED



99337

LED



99338

LED

99337 CRESPILLO

surface-mounted light; plastic, steel, white / plastic, white
 Aufbauleuchte; Kunststoff, Stahl, weiss / Kunststoff, weiss
 luminaire en saillie; plastique, acier, blanc / plastique, blanc

H 45, Ø 240



12,5W 1350lm

99338 CRESPILLO

surface-mounted light; plastic, steel, white / plastic, white
 Aufbauleuchte; Kunststoff, Stahl, weiss / Kunststoff, weiss
 luminaire en saillie; plastique, acier, blanc / plastique, blanc

H 45, Ø 315



15W 1800lm

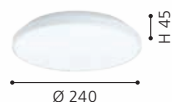



99726

LED



99727

LED

99726 CRESPILLO

surface-mounted light; plastic, white / plastic, white
Aufbauleuchte; Kunststoff, weiss / Kunststoff, weiss
luminaire en saillie; plastique, blanc / plastique, blanc

H 65, Ø 380

LED

21 W

neutral
WHITE

3000lm



99727 CRESPILLO

surface-mounted light; plastic, white / plastic, white
Aufbauleuchte; Kunststoff, weiss / Kunststoff, weiss
luminaire en saillie; plastique, blanc / plastique, blanc

H 65, Ø 500

LED

29 W

neutral
WHITE

4800lm

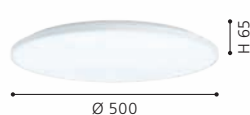
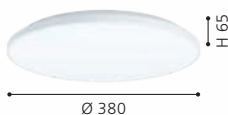



901043



901044



BOHOYO

These luminaires can be used as recessed or surface-mounted lights. The head of the light is surface-mounted lights. The head of the light is movable and can be rotated.

Diese Leuchten können als Ein- oder Aufbauleuchten verwendet werden. Der Kopf der Leuchte ist beweglich und kann gedreht werden.

Ces luminaires peuvent être utilisés comme luminaires encastrés ou apparents. La tête du luminaire est mobile et peut être tournée.



901043 BOHOYO

spot; aluminium, white / plastic, transparent
Spot; Alu, weiss / Kunststoff, transparent
spot; aluminium, blanc / plastique, transparent

L 100, H 110, ET 40



1x 8W 1000lm



9 008606 315949



901044 BOHOYO

spot; aluminium, black / plastic, transparent
Spot; Alu, schwarz / Kunststoff, transparent
spot; aluminium, noir / plastique, transparent

L 100, H 110, ET 40



1x 8W 1000lm



9 008606 315956





901044

LED





94501

LED



94502

LED



94504

LED

94501 POLASSO

ceiling light; aluminium, plastic, black, copper
Deckenleuchte; Alu, Kunststoff, schwarz, kupfer
plafonnier; aluminium, plastique, noir, cuivre

H 120, Ø 100



3,3W 340lm



9 002759 945015



94504 POLASSO

ceiling light; aluminium, plastic, white, silver
Deckenleuchte; Alu, Kunststoff, weiss, silber
plafonnier; aluminium, plastique, blanc, argent

H 120, Ø 100



3,3W 340lm



9 002759 945046



94502 POLASSO

ceiling light; aluminium, plastic, black, gold
Deckenleuchte; Alu, Kunststoff, schwarz, gold
plafonnier; aluminium, plastique, noir, or

H 120, Ø 100



3,3W 340lm



9 002759 945022





94503

LED



94501

LED

94503 POLASSO

ceiling light; aluminium, plastic, white, gold
Deckenleuchte; Alu, Kunststoff, weiss, gold
plafonnier; aluminium, plastique, blanc, or

H 120, Ø 100

LED

3,3W

warm
WHITE

340lm



9 002759 945039





94496

LED



94499

LED



94497

LED

94496 POLASSO

ceiling light; aluminium, plastic, black, copper
Deckenleuchte; Alu, Kunststoff, schwarz, kupfer
plafonnier; aluminium, plastique, noir, cuivre

L 100, B 100, H 120



3,3W 340lm



9 002759 944964

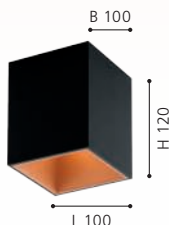

94497 POLASSO

ceiling light; aluminium, plastic, black, gold
Deckenleuchte; Alu, Kunststoff, schwarz, gold
plafonnier; aluminium, plastique, noir, or

L 100, B 100, H 120



3,3W 340lm



9 002759 944971

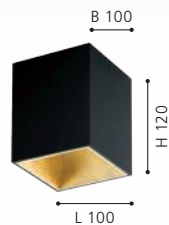

94499 POLASSO

ceiling light; aluminium, plastic, white, silver
Deckenleuchte; Alu, Kunststoff, weiss, silber
plafonnier; aluminium, plastique, blanc, argent

L 100, B 100, H 120



3,3W 340lm



9 002759 944995

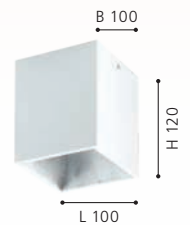



94497

LED

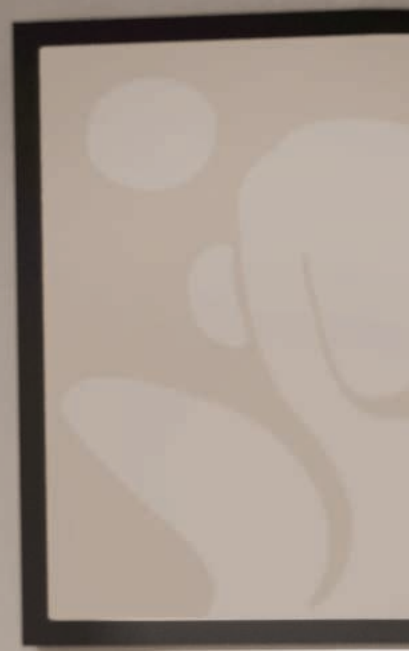

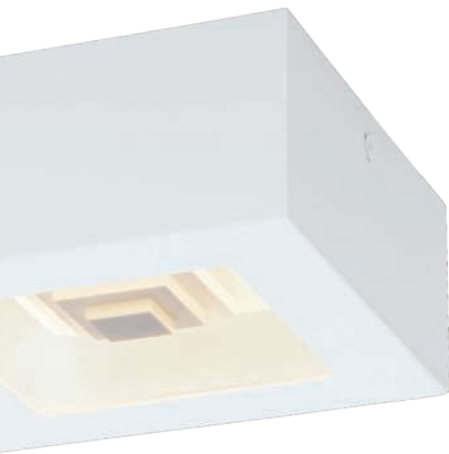

FERREROS

These luminaires have a special leveling effect.

Diese Leuchten besitzen einen besonderen Stufeneffekt.

Ces luminaires ont un effet escalier spécial.

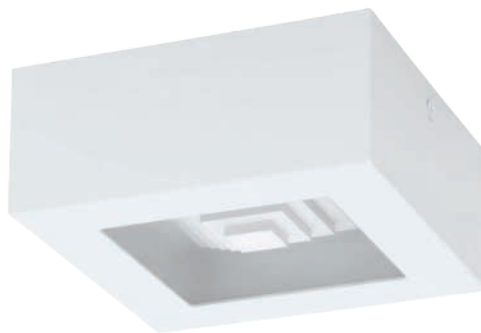

96791

LED

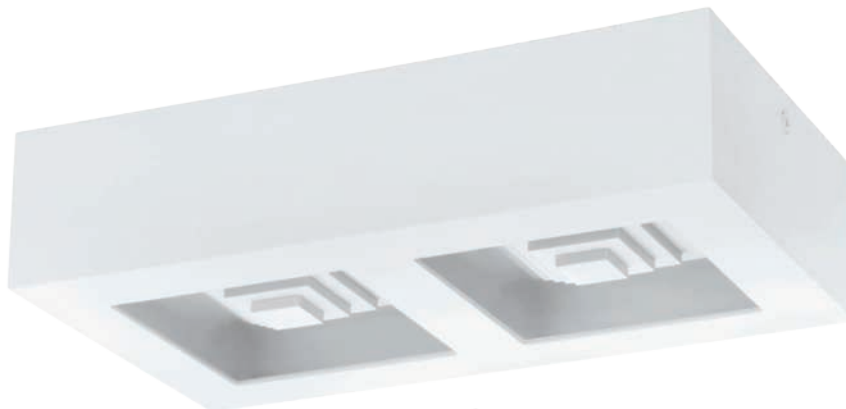

96792

LED



96794

LED

96791 FERREROS

wall/ceiling light; steel, white / plastic, white
Wand- / Deckenleuchte; Stahl, weiss / Kunststoff, weiss
Applique/Plafonnier; acier, blanc / plastique, blanc

L 140, B 140, H 60



1x 6,3W 840lm

96792 FERREROS

wall/ceiling light; steel, white / plastic, white
Wand- / Deckenleuchte; Stahl, weiss / Kunststoff, weiss
Applique/Plafonnier; acier, blanc / plastique, blanc

L 255, B 140, H 60



2x 6,3W 1680lm

96794 FERREROS

wall/ceiling light; steel, white / plastic, white
Wand- / Deckenleuchte; Stahl, weiss / Kunststoff, weiss
Applique/Plafonnier; acier, blanc / plastique, blanc

L 270, B 270, H 60



4x 6,3W 3360lm



9 002759 967918

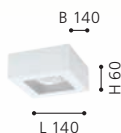

9 002759 967925

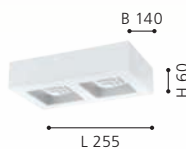

9 002759 967949

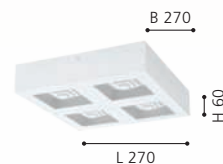

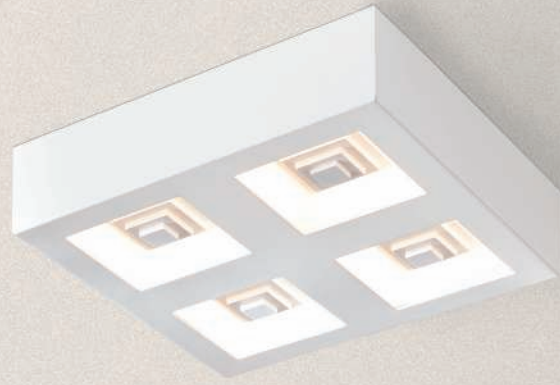

96794

LED





LED STRIPES

ADVANTAGES

- > HOMOGENEOUS LIGHT DISTRIBUTION - IDEAL FOR ILLUMINATING ROOMS AND SURFACES
- > DIFFERENT LIGHT TEMPERATURES:
WARM WHITE/NEUTRAL WHITE AND FUNCTIONS SUCH AS RGB, MOTION SENSOR
- > LOW HEAT GENERATION ENSURES GREATER SAFETY
- > UP TO 80% ENERGY SAVINGS COMPARED TO INCANDESCENT LAMPS, PROTECTING YOUR BUDGET AND THE ENVIRONMENT
- > SIMPLE WIRING THANKS TO INTEGRATED TERMINAL CONNECTION ON THE DRIVER
- > ALL STRIPS HAVE A SELF-ADHESIVE BACKING AND CAN BE CUT TO LENGTH ONCE
- > FREE MOUNTING OR IN LED PROFILE

VORTEILE

- > HOMOGENE LICHTVERTEILUNG – IDEAL ZUR BELEUCHTUNG VON RÄUMEN UND FLÄCHEN
- > VERSCHIEDENE LICHTTEMPERATUREN:
WARMWHITE/NEUTRAL WHITE UND FUNKTIONEN WIE RGB, MOTION SENSOR
- > GERINGE WÄRMEENTWICKLUNG SORGT FÜR MEHR SICHERHEIT
- > BIS ZU 80% STROMERSPARNIS GEGENÜBER GLÜHLAMPEN, SCHONT IHR BUDGET UND DIE UMWELT
- > EINFACHE VERKABELUNG DURCH INTEGRIERTEN KLEMMANSCHLUSS AM TREIBER
- > ALLE STREIFEN MIT SELBSTKLEBENDER RÜCKSEITE UND EINMALIG KÜRZBAR
- > MONTAGE FREI ODER IN LED PROFIL

AVANTAGES

- > RÉPARTITION HOMOGENÈ DE LA LUMIÈRE - IDÉAL POUR L'ÉCLAIRAGE DE PIÈCES ET DE SURFACES
- > DIFFÉRENTES TEMPÉRATURES DE LUMIÈRE :
WARMWHITE/NEUTRAL WHITE ET FONCTIONS TELLES QUE RGB, MOTION SENSOR
- > UN FAIBLE DÉGAGEMENT DE CHALEUR ASSURE UNE PLUS GRANDE SÉCURITÉ
- > JUSQU'À 80% D'ÉCONOMIE D'ÉNERGIE PAR RAPPORT AUX LAMPES À INCANDESCENCE, PRÉSERVE VOTRE BUDGET ET L'ENVIRONNEMENT
- > CÂBLAGE SIMPLE GRÂCE AU RACCORD DE SERRAGE INTÉGRÉ AU DRIVER
- > TOUTES LES BANDES ONT UN VERSO AUTOCOLLANT ET PEUVENT ÊTRE RACCOURCIES UNE SEULE FOIS
- > MONTAGE LIBRE OU DANS UN PROFILÉ LED

OVERVIEW



COB STRIPE
290-291



FLEXIBLE STRIPE
292-296



LED STRIPES-FLEX
296



This product is available in different colors and shapes./ Dieser Artikel ist in unterschiedlichen Farben und Formen verfügbar/
Cet article est disponible en différentes couleurs et formes.



LED STRIPES

COB STRIPES

ADVANTAGES

- > PREMIUM LED STRIPS WITHOUT VISIBLE LIGHT POINTS
- > HOMOGENEOUS LIGHT EMISSION ALONG THE ENTIRE LENGTH
- > 480 LEDS/METRE
- > LATEST CHIP ON BOARD (COB) TECHNOLOGY
- > DRIVER INCLUDED

VORTEILE

- > PREMIUM LED-STREIFEN OHNE SICHTBARE LICHTPUNKTE
- > HOMOGENE LICHTABSTRAHLUNG ÜBER DIE GESAMTE LÄNGE
- > 480 LEDS / METER
- > NEUESTE CHIP ON BOARD (COB) TECHNOLOGIE
- > TREIBER INKLUDIERT

AVANTAGES

- > BANDE LED PREMIUM SANS POINTS LUMINEUX VISIBLES
- > ÉMISSION DE LUMIÈRE HOMOGENÈNE SUR TOUTE LA LONGUEUR
- > 480 LED/MÈTRE
- > DERNIÈRE TECHNOLOGIE CHIP ON BOARD (COB)
- > PILOTE INCLUS

900574 COB STRIPE

bar/strip light; plastic, white
Leuchtband/-stab; Kunststoff, weiss
bande lumineuse / bâton l; plastique, blanc

L 2000



16W 1400lm



9 008606 244751



L 2000

900575 COB STRIPE

bar/strip light; plastic, white
Leuchtband/-stab; Kunststoff, weiss
bande lumineuse / bâton l; plastique, blanc

L 5000



40W 3500lm



9 008606 244768



L 5000

900576 COB STRIPE

bar/strip light; plastic, white
Leuchtband/-stab; Kunststoff, weiss
bande lumineuse / bâton l; plastique, blanc

L 8000



64W 5600lm



9 008606 244775



L 8000

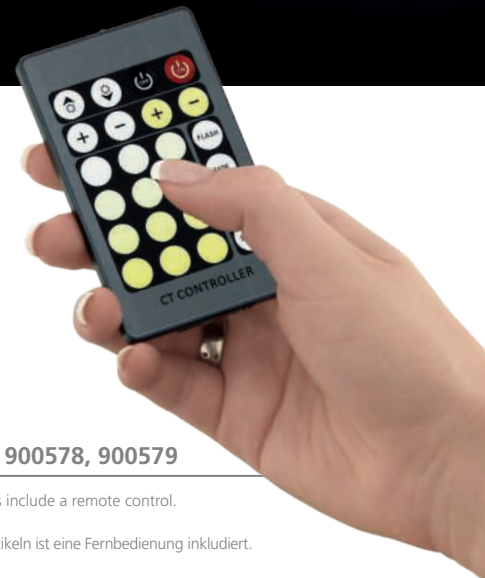
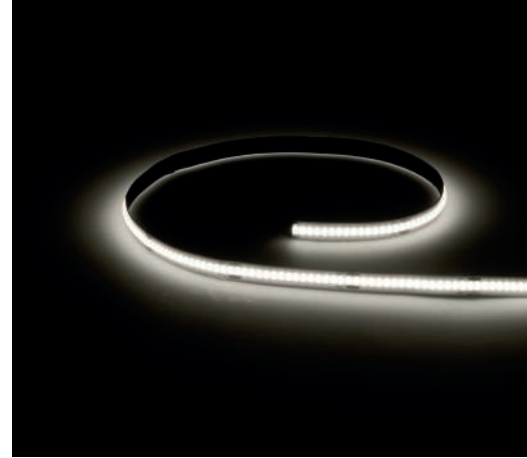

900574

LED

900575

LED

900576

LED



900577

LED

900578

LED

900579

LED

900577, 900578, 900579

These articles include a remote control.

Bei diesen Artikeln ist eine Fernbedienung inkludiert.

Ces articles comprennent une télécommande.

900577 COB STRIPE

bar/strip light; plastic, white
Leuchtband/-stab; Kunststoff, weiss
bande lumineuse / bâton l; plastique, blanc

L 2000



13,2W



1320lm



Remote



9 008606 244782



L 2000

900578 COB STRIPE

bar/strip light; plastic, white
Leuchtband/-stab; Kunststoff, weiss
bande lumineuse / bâton l; plastique, blanc

L 5000



33W



3300lm



Remote



9 008606 244799



L 5000

900579 COB STRIPE

bar/strip light; plastic, white
Leuchtband/-stab; Kunststoff, weiss
bande lumineuse / bâton l; plastique, blanc

L 8000



52,8W



5280lm



Remote



9 008606 244805



L 8000



LED STRIPES

FLEXIBLE STRIPES

ADVANTAGES

- > FREELY FORMABLE
- > SELF-ADHESIVE
- > SEPARABLE EVERY 10 CM
- > OPTIMAL ILLUMINATION EVEN IN CORNERS
- > NO SOLDERING OR INTERMEDIATE PIECE NECESSARY

VORTEILE

- > FREI FORMBAR
- > SELBSTKLEBEND
- > ALLE 10 CM KÜRZBAR
- > OPTIMALE AUSLEUCHTUNG AUCH IN ECKEN
- > KEIN LÖTEN ODER ZWISCHENSTÜCK NOTWENDIG

AVANTAGES

- > SE DÉFORME AISEMENT
- > AUTO-ADHÉSIF
- > PEUT ÊTRE SECTIONNÉ TOUS LES 10 CM
- > UN ÉCLAIRAGE OPTIMAL, MÊME DANS LES COINS
- > PAS DE SOUDURE OU DE PIÈCE INTERMÉDIAIRE NÉCESSAIRE

98571 FLEXIBLE STRIPE

bar/strip light; plastic, white
 Leuchtband/-stab; Kunststoff, weiss
 bande lumineuse / bâton |; plastique, blanc

L 2000, B 6

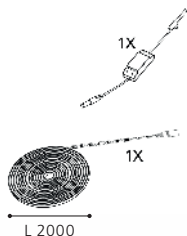

98572 FLEXIBLE STRIPE

bar/strip light; plastic, white
 Leuchtband/-stab; Kunststoff, weiss
 bande lumineuse / bâton |; plastique, blanc

L 5000, B 6

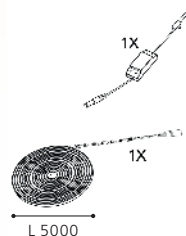

99716 FLEXIBLE STRIPE

bar/strip light; white
 Leuchtband/-stab; weiss
 bande lumineuse / bâton |; blanc

L 8000, B 6

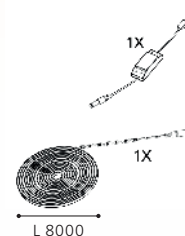



99717 FLEXIBLE STRIPE

bar/strip light; white
Leuchtband/-stab; weiss
bande lumineuse / bâton l; blanc

L 2000, B 6

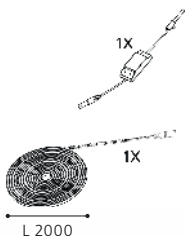

99718 FLEXIBLE STRIPE

bar/strip light; white
Leuchtband/-stab; weiss
bande lumineuse / bâton l; blanc

L 5000, B 6

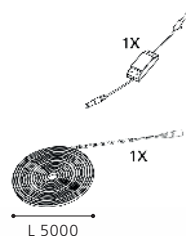

99719 FLEXIBLE STRIPE

bar/strip light; white
Leuchtband/-stab; weiss
bande lumineuse / bâton l; blanc

L 8000, B 8

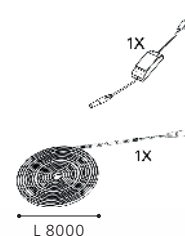

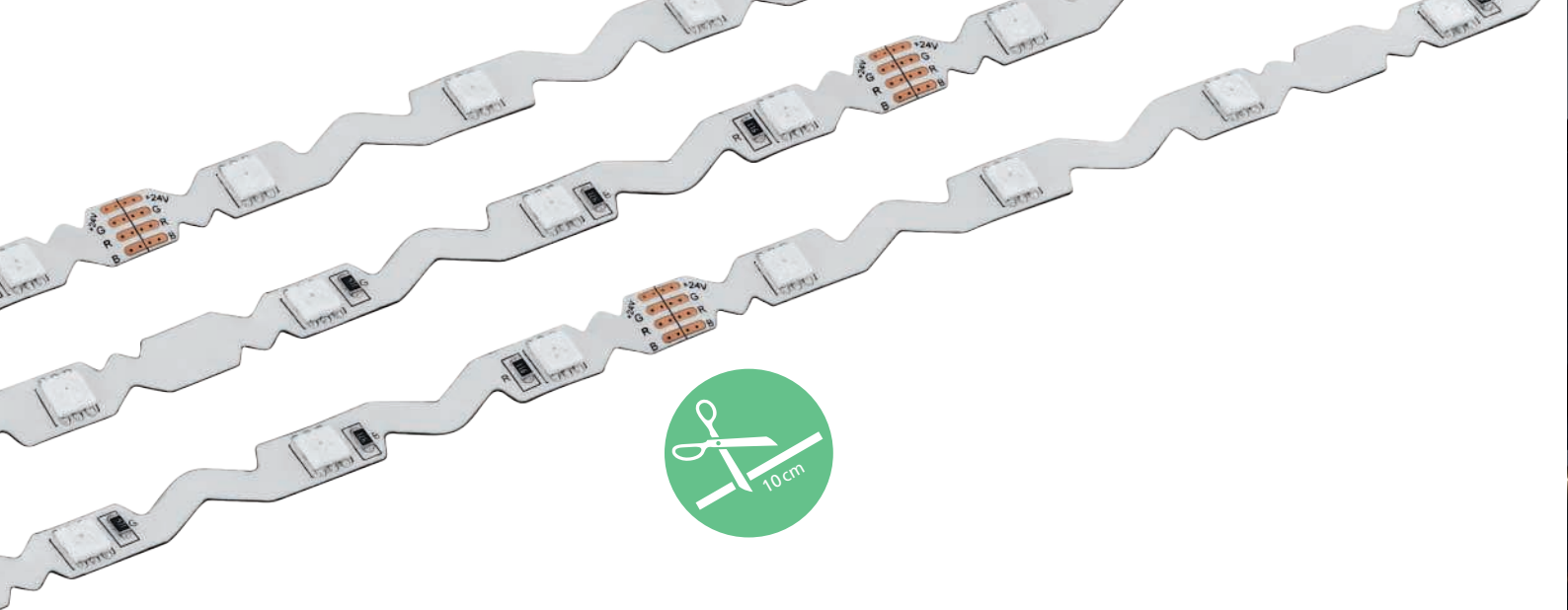

	98573	98574
RGB	LED	LED



FLEXIBLE STRIPE

These LED strips are very flexible and are perfect for shaping.

Diese LED-Streifen sind sehr flexibel und eignen sich perfekt zum Formen.

Ces bandes LED sont très flexibles et conviennent parfaitement à la mise en forme.

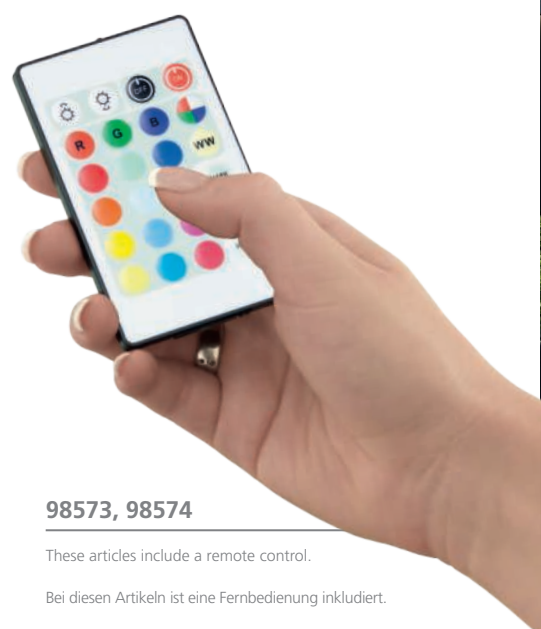

98573, 98574

These articles include a remote control.

Bei diesen Artikeln ist eine Fernbedienung inkludiert.

Ces articles comprennent une télécommande.

98573 FLEXIBLE STRIPE

bar/strip light; plastic, white
 Leuchtband/-stab; Kunststoff, weiss
 bande lumineuse / bâton l; plastique, blanc

L 2000, B 8

				
9,7W			Remote	

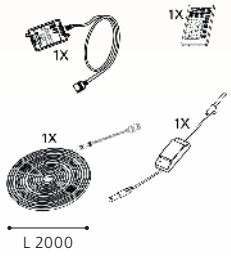

9 002759 985738

L 2000

98574 FLEXIBLE STRIPE

bar/strip light; plastic, white
 Leuchtband/-stab; Kunststoff, weiss
 bande lumineuse / bâton l; plastique, blanc

L 5000, B 8

				
19,5W			Remote	

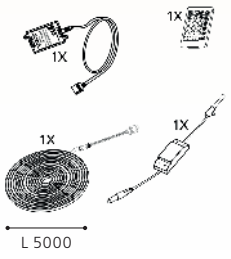

9 002759 985745

L 5000



REMOTE CONTROL

With the aid of the remote control, all LED STRIPES can be dimmed. This note indicates that the remote control is included with the delivery.

Mit Hilfe der Fernbedienung können sämtliche LED-STRIPES gedimmt werden. Bei diesem Hinweis ist die Fernbedienung im Lieferumfang enthalten!

Au moyen de la télécommande, tous les LED STRIPES peuvent être gradués. Avec cette remarque, la télécommande est comprise dans l'étendue de la livraison !



tunable
WHITE

99721
LED

99722
LED

99723
LED

99721, 99722, 99723

These articles include a remote control.

Bei diesen Artikeln ist eine Fernbedienung inkludiert.

Ces articles comprennent une télécommande.

99721 FLEXIBLE STRIPE

bar/strip light; white
Leuchtband/-stab; weiss
bande lumineuse / bâton l; blanc

L 2000, B 8



2x 4,6W

960lm

Remote

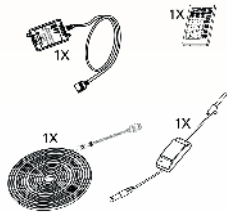

L 2000



9 002759 997212

99722 FLEXIBLE STRIPE

bar/strip light; white
Leuchtband/-stab; weiss
bande lumineuse / bâton l; blanc

L 5000, B 8



5x 4,6W

2400lm

Remote

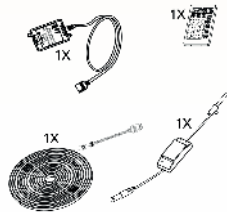

L 5000



9 002759 997229

99723 FLEXIBLE STRIPE

bar/strip light; white
Leuchtband/-stab; weiss
bande lumineuse / bâton l; blanc

L 8000, B 8



8x 4,6W

3840lm

Remote

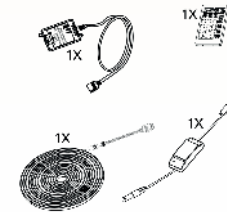

L 8000



9 002759 997236

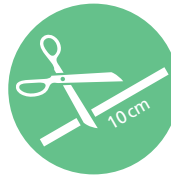
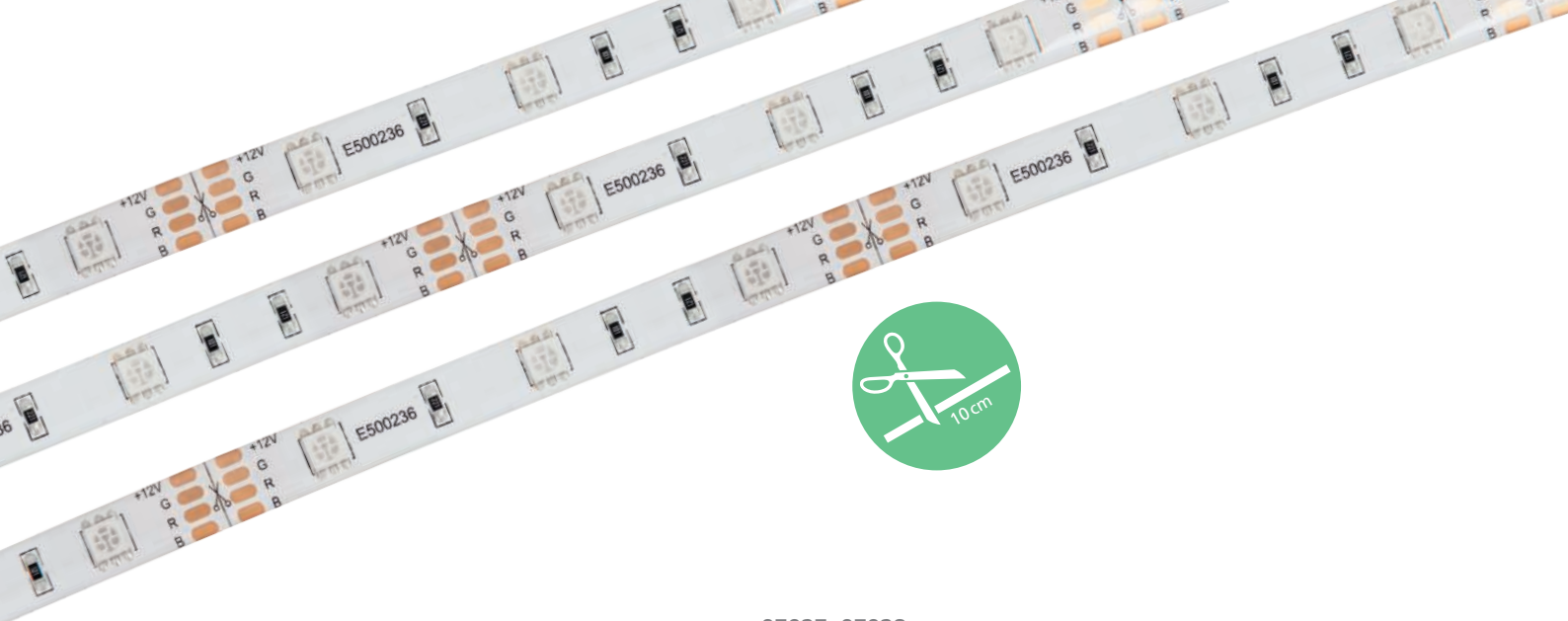

97927, 97928

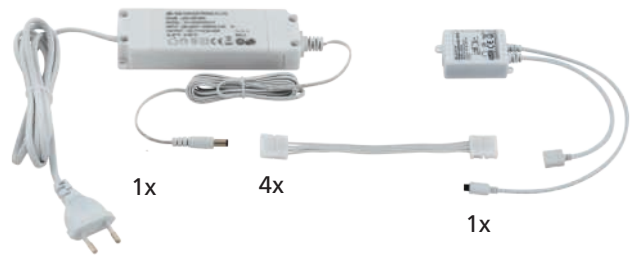

1x

4x

1x

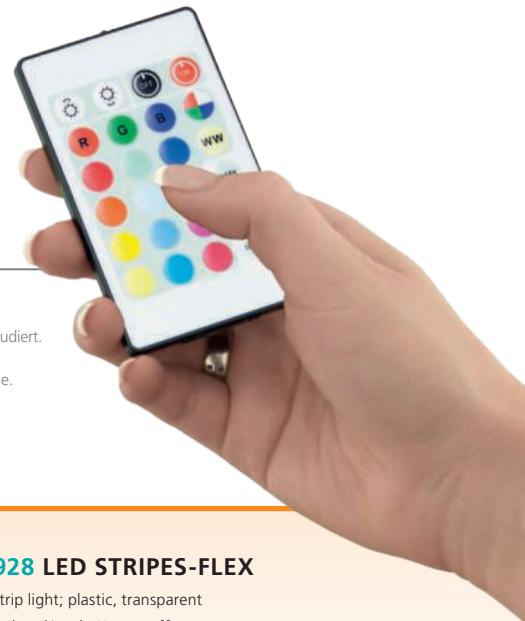

97924, 97927, 97928

These articles include a remote control.

Bei diesen Artikeln ist eine Fernbedienung inkludiert.

Ces articles comprennent une télécommande.

97924 FLEXIBLE STRIPE

bar/strip light; white
Leuchtband/-stab; weiss
bande lumineuse / bâton l; blanc

L 8000, B 8



38,4W

Remote



9 002759 997243



L 8000

97927 LED STRIPES-FLEX

bar/strip light; plastic, transparent
Leuchtband/-stab; Kunststoff, transparent
bande lumineuse / bâton l; plastique, transparent

L 2000, B 10, H 3



10W

760lm

Remote



10



9 002759 979270



L 2000

97928 LED STRIPES-FLEX

bar/strip light; plastic, transparent
Leuchtband/-stab; Kunststoff, transparent
bande lumineuse / bâton l; plastique, transparent

L 5000, B 10, H 3



20W

1900lm

Remote



10



9 002759 979287



L 5000



97927



97928



EGLO WORLDWIDE

EGLO WELTWEIT / EGLO DANS LE MONDE



 **AUSTRIA**
EGLO LEUCHTEN GMBH

Heiligkreuz 22
6136 Pill
T: +43 5242 6996 110 | F: +43 5242 6996 972
info-austria@eglo.com

 **CHILE**
EGLO CHILE ILUMINACIÓN LTDA.

Av. Américo Vespucio Norte 1930
Conchalí - Santiago de Chile
T: +562 2 595 2222
info-chile@eglo.com

 **DENMARK**
EGLO DANMARK A/S

Agerbakken 20
8362 Hørning
T: +45 70 22 55 11
info-denmark@eglo.com

 **AUSTRALIA**
EGLO LIGHTING AUSTRALIA

5/339 Archerfield Road
4077 Richlands | Queensland
T: +61 7 3375 1413 | F: +61 7 3375 1412
info@eglolighting.com.au

 **CHINA**
DONGGUAN EGLO LIGHTING
COMMERCIAL CO LTD

No.1 | Shangqiao Industrial Rd Shangqiao, Dongcheng
Dongguancity, Guanzhouprovince
T: +86 769 2203 3866 | F: +86 769 2203 6866
info-china@eglo.com

 **ESTONIA**
MOODNE VALGUSTUS AS

Rävala pst. 7
10143 Tallinn
T: +372 667 6670 | F: +372 631 3195
info-estonia@eglo.com

 **BELGIUM**
EGLO BELGIUM BV

Antwerpsesteenweg 247
2950 Kapellen
T: +32 3 250 60 80 | F: +32 3 219 80 67
info-belgium@eglo.com

 **COLOMBIA**
EGLO COLOMBIA ILUMINACIÓN SAS

Autopista Norte 800 Mts adelante del Peaje de los Andes
Costado Oriental Km 19 Lote 30
Bogotá - Chia
T: +57 (1) 744 2339
info-colombia@eglo.com

 **FINLAND**
EGLO FINLAND OY

Malmi raitti 17A
00700 Helsinki
T: +358 20 7649 820
info-finland@eglo.com

 **BOSNIA AND HERZEGOVINA**
EGLO RASVIJETA BH D.O.O.

Hrgovi Donji 178
76250 Gradacac
T: +387 35 86 85 00 | F: +387 35 82 44 41
info-Bosnia-Herzegovina@eglo.com | info@eglo.ba

 **COSTA RICA**
EGLO COSTA RICA

Centro Comercial Calle Real local #8 de la sucursal del
BAC San José 800 metros al norte Guachipilín de Escazú
San José, Costa Rica
T: +506-2289-4690 | F: +506-2100-6384
info-costarica@eglo.com

 **FRANCE**
EGLO FRANCE LUMINAIRE SARL

Z.A. Jeune Bois | 2 Rue de la Martinique
68274 Wittenheim
T: +33 3 89 62 50 45 | F: +33 389 6250 49
info-france@eglo.com

 **BULGARIA**
EGLO BULGARIA EOOD

Main Road Burgas-Sofia | 5th kilometer | Building EGLO
8000 Burgas
T: +359 888 755 509
info-bulgaria@eglo.com

 **CROATIA**
EGLO RASVIJETA D.O.O.

Jadranska avenija 9
10020 Zagreb
T: +385 1 379 40 62 | F: +385 1 379 41 04
info-croatia@eglo.com

 **GERMANY**
EGLO LEUCHTEN HANDELS GMBH

Kleinbahnstr. 35
59759 Arnsberg
T: +49 2932 6269 0 | F: +49 2932 6269 39
info-germany@eglo.com

 **CANADA**
EGLO CANADA INC.

20700 Route Transcanadienne
H9X 4B7 Baie D'Ufré, Quebec
T: +1 514 457 5483 | F: +1 514 457 5487
info-canada@eglo.com

 **CZECH REPUBLIC**
EGLO CZ+SK s.r.o.

Náchodská 2479/63
193 00 Praha 9
T: +420 281 924 163 | F: +420 281 925 205
info-czechrepublic@eglo.com

 **GREAT BRITAIN AND IRELAND**
EGLO UK LTD.

54 Denington Rd, Denington Industrial Estate
Wellingborough NN8 2QH, UK
T: +44 1604 790 986
info-UK@eglo.com

**GREECE**

EGLO HELLAS A.E.

Sykias 2 and parodos dekeleias
13679 Acharnai
T: +30 21 0800 2363
info-greece@eglo.com

**HUNGARY**

EGLO LUX KFT.

Fő út 143/A
2120 Dunakeszi
T: +36 27 341 353
info-hungary@eglo.com

**INDIA**

EGLO INDIA PRIVATE LIMITED

A-307, Ansal Chambers - 1, 3, Bhikaji Cama Place,
110066 Delhi
T: +91 85279 44288
info-india@eglo.com

**ITALY**

EGLO ITALIANA S.R.L.

Via Giotto, 4
31021 Mogliano Veneto (TV)
T: +39 041 45 66 245 | F: +39 041 45 74 066 / 071
info-italy@eglo.com

**KAZAKHSTAN**

EGLO KAZAKHSTAN LLP

Al-Farabi Avenue 7, Office 72, 14rd floor, Block 4A,
Nurly-Tau Business Center
50059 Almaty
T: +7 727 293 25 20 | M: +7 701 031 00 00
info-kazakhstan@eglo.com

**KOSOVO**

EGLO KOSOVA LLC

Lugisht e qytetit pn
20000 Prizren
T: +383 44 216 687 | SHOP: +383 49 699 100
info-kosovo@eglo.com

**LATVIA**

MOODNE VALGUSTUS AS

Rāvala pst.7
10143 Tallinn
T: +370 652 49923 | T: +372 667 6670
info-latvia@eglo.com

**LITHUANIA**

MOODNE VALGUSTUS AS

Rāvala pst.7
10143 Tallinn
T: +370 652 49923 | T: +372 667 6670
info-lithuania@eglo.com

**MALAYSIA**

EGLO ASIA SDN BHD

B-07-13, Empire Soho, Empire Subang, Jalan SS 16/1,
47500 Subang Jaya, Selangor Darul Ehsan.
T: +60162115313
info-malaysia@eglo.com

**MEXICO**

EGLO MÉXICO ILUMINACIÓN S DE RL DE CV

Prolongación Avenida López Mateos Sur N°3561,
Fraccionamiento Los Gavilanes
C.P. 45645 Tlajomulco de Zúñiga | Jalisco
T: +52 33 3687 20 95
info-mexico@eglo.com

**MIDDLE EAST**

EGLO LIGHTING MIDDLE EAST FZE

P.O. BOX 262073, LOB6, OFFICE G18
Jebel Ali, Dubai, UAE
T: +97 148810080 | F: +97 148810081
gulf@eglo.com

**MOROCCO - EGLO AFRICA**

EGLO MAGHREB LUMINAIRES SARL

219 Bd Med Zerkoutouni. Suite: 67
20230 Casablanca
T: +212 522 98 80 25 / -05
info-global@eglo.com | info.africa@eglo.com

**THE NETHERLANDS**

EGLO VERLICHTING NEDERLAND B.V.

Innovatiepark 20
4906 AA Oosterhout (NB)
T: +31 162 48 28 30
info-nl@eglo.com

**NORWAY**

MS BELYSNING

Gardermovegen 95B
2030 Nannestad
T: +47 63 888500 | F: +47 63 888501
info-norway@eglo.com

**SLOVAKIA**

EGLO CZ+SK s.r.o

Náchodská 2479/63
193 00 Praha 9
T: +421 313 211 551 | F: +421 313 211 556
info-slovakia@eglo.com

**SLOVENIA**

EGLO RASVJETA D.O.O.

Jadranska avenija 9
10020 Zagreb
T: +386 158 093 18
info-slovenia@eglo.com

**SPAIN**

EGLO ESPANA ILUMINACIÓN S.L.

Avda. de Castilla,1 (Edif. Best Point) 2º Planta - Oficina
16A-B
28830 San Fernando de Henares, Madrid
T: +34 91 677 90 44 | F: +34 91 677 03 04
info-spain@eglo.com

**SWEDEN**

EGLO SVRIGE AB

Star Street 1
512 50 Svenljunga
T: +46 340 623 505
info-sweden@eglo.com

**SWITZERLAND**

EGLO SCHWEIZ AG

Seetalstrasse 142
6032 Emmen
T: +41 41 268 69 59
info-switzerland@eglo.com

**TURKEY**

EGLO Aydınlatma ithalat ihracat Ltd. Şti.

Eyüp Sultan Mah. Sekmen Cad. No:18/2
34885 Sancaktepe / Istanbul Samandıra
T: +90 216 311 09 -02 / -03 / -04 |
F: +90 216 311 09 / -05
info-turkey@eglo.com

**UKRAINE**

EGLO UKRAINE LTD

Vatslava Gavela boulevard, 6/7-A,
03124 Kyiv
T: +38 067 670 58 61
info-ukraina@eglo.com

**USA**

EGLO USA, INC.

3640 Royal South Parkway
30349 Atlanta, Georgia
T: +1 404 477 5601 | F: +1 404 393 7053
info-usa@eglo.com

**POLAND**

EGLO POLSKA SP. Z O.O.

Ul. Dżwiękowa 2
02-857 Warszawa
T: +48 22 644 57 55 | T: +48 22 644 89 82
info-poland@eglo.com

**PORTUGAL**

EGLO PORTUGAL ILUMINAÇÃO, LDA

Rua Fonte Parada, 125
4595-434 Seroa-Paços de Ferreira
T: +351 255 890 000
info-portugal@eglo.com

**ROMANIA**

EGLO ROMANIA PRODEXIM SRL.

Str. Atomistilor nr. 1D
77125 Magurele - Ilfov
T: +40 314 250 902 | F: +40 314 250 899
info-romania@eglo.com

**RUSSIA**

EGLO LIGHTING LLC

Varshavskoe shosse 3 | Office 23
117105 Moscow
T: +7495 789 4311 | F: +7495 789 4312
info-russia@eglo.com

**SERBIA**

EGLO RASVETA DOO

Stefana Prvovenčanog 28
11000 Beograd
T: +381 11 3981 366 | F: +381 11 3981 389
info-serbia@eglo.com

HOW TO READ

ERKLÄRUNG

COMMENT LIRE

ARTICLE NUMBER & SERIES NAME
ARTIKELNUMMER & SERIENNAME
NUMÉRO D'ARTICLE & NOM DE LA SÉRIE

DIMENSIONS
DIMENSIONEN
DIMENSIONS

all dimensions in mm | alle Größen in mm | toutes dimensions en mm

L = length | Länge | longueur

B = width | Breite | largeur

H = height | Höhe | hauteur

Ø = diameter | Durchmesser | diamètre

A = projection length | Ausladung | amplitude

ET = installation depth | Einbautiefe | profondeur utile

Base = base dimensions | Sockelmaße | dimensions de base

Attention! The dimensions relate solely to the sizes of the luminaire. Any air spaces that would be relevant for a safe operating of the lamp were not considered.

Achtung! Die Größen beziehen sich nur auf die Abmessungen der Leuchte. Etwaige Lufträume, die für einen sicheren Betrieb der Leuchte notwendig sind, werden nicht berücksichtigt.

Attention! Les dimensions se réfèrent à la taille de la lampe seulement. Espacements éventuels, que seraient importants pour une opération de la lampe sans danger, n'ont pas été considérés.

PICTOGRAMMES
PIKTOGRAMME
PIKTOGRAMMES

Technical details are represented as pictograms. An overview over all pictograms can be found on the next pages.

Technische Details werden als Piktogramme dargestellt. Eine Übersicht über alle Piktogramme finden Sie auf den nächsten Seiten.

Les détails techniques sont représentés sous forme de pictogrammes. Vous trouverez un aperçu de tous les pictogrammes dans les pages suivantes.

BUTTONS
BOUTONS
BOUTONS

Bulb included
Leuchtmittel inkludiert
ampoules inclus 

Recessed Luminaire
Einbauleuchte
luminaire encastrable 

Surface Luminaire
Aufbauleuchte
luminaire en saillie 

DESCRIPTION
BESCHREIBUNG
DESCRIPTION

The product description is composed as follows:
luminaire type; enclosure material, enclosure colour / glass or shade material, glass or shade colour

Die Produktbeschreibung setzt sich wie folgt zusammen:
Leuchtenart; Gehäusematerial, Gehäusefarbe / Schirm- bzw. Glasmaterial, Schirm- bzw. Glasfarbe

La description du produit est composée comme suit:
type de luminaire; matériel de boîtier, couleur de boîtier / matériel de verre ou abat-jour, couleur de verre ou abat-jour

SKETCHES
SKIZZEN
CROQUIS

The sketches state the most meaningful dimensions. If a product is adjustable by will, a turquoise arrow marks this function and only the maximum dimensions are indicated.

Die Bemaßung der Skizzen umfasst jeweils die aussagekräftigsten Größen. Bei verstellbaren Produkten kennzeichnet ein türkiser Pfeil diese Funktion und nur die maximalen Größen werden angegeben.

Les dimensions des croquis comprennent les plus représentatives. Si un produit est réglable au choix, une flèche turquoise affiche cette fonction et rien que les dimensions maximales sont indiquées.

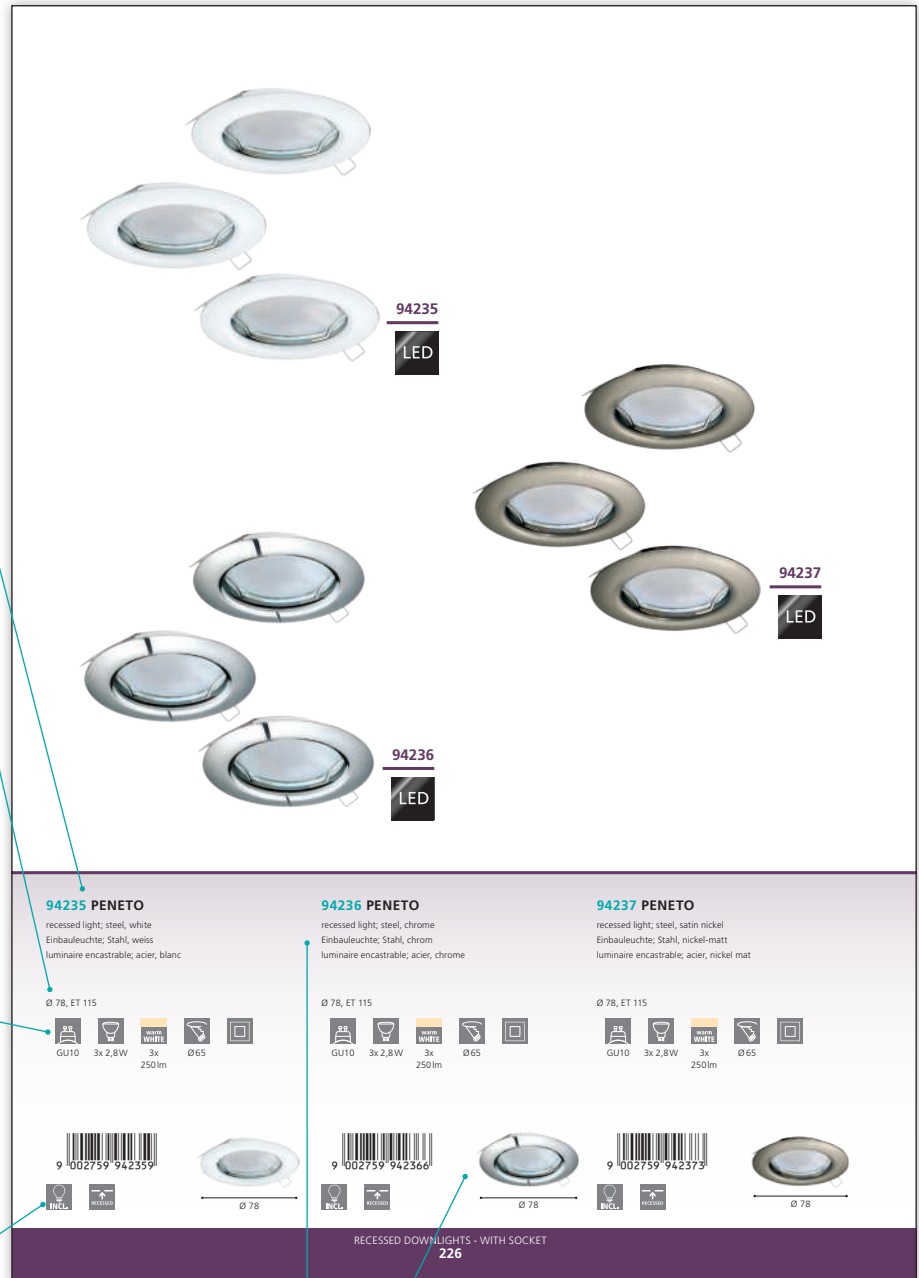

94235 PENETO
recessed light; steel, white
Einbauleuchte; Stahl, weiss
luminaire encastrable; acier, blanc
Ø 78, ET 115
GU10 3x 2,8W 3x 250lm Ø65

94236 PENETO
recessed light; steel, chrome
Einbauleuchte; Stahl, chrom
luminaire encastrable; acier, chrome
Ø 78, ET 115
GU10 3x 2,8W 3x 250lm Ø65

94237 PENETO
recessed light; steel, satin nickel
Einbauleuchte; Stahl, nickel-matt
luminaire encastrable; acier, nickel mat
Ø 78, ET 115
GU10 3x 2,8W 3x 250lm Ø65

RECESSED DOWNLIGHTS - WITH SOCKET
226

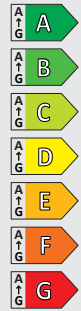
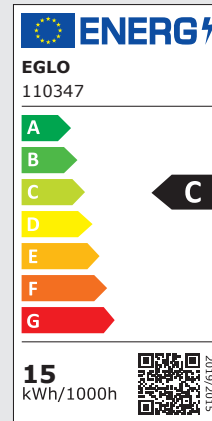

FUEVA 5
Ø 166, ET 26
recessed light
Einbauleuchte
luminaire encastrable

Material / Colour	Size	Cutout	Watt	Lumen	IP class	Item no.	EAN code
steel, white / plastic, white Stahl, weiss / Kunststoff, weiss acier, blanc / plastique, blanc	Ø 166, ET 26	Ø 155	11W	1350lm		99133	9 002759 991333
	Ø 166, ET 26	Ø 155	11W	1350lm		99192	9 002759 991920
	Ø 166, ET 26	Ø 155	11W	1350lm	IP44	99203	9 002759 992033
	Ø 166, ET 26	Ø 155	11W	1350lm	IP44	99149	9 002759 991494
	Ø 166, ET 26	Ø 155	11W	1350lm	IP44	99207	9 002759 992071
steel, satin nickel / plastic, white Stahl, nickel-matt / Kunststoff, weiss acier, nickel mat / plastique, blanc	Ø 166, ET 26	Ø 155	11W	1350lm		99138	9 002759 991388
	Ø 166, ET 26	Ø 155	11W	1350lm		99154	9 002759 991548
steel, chrome / plastic, white Stahl, chrom / Kunststoff, weiss acier, chrome / plastique, blanc	Ø 166, ET 26	Ø 155	11W	1350lm	IP44	99205	9 002759 992057
	Ø 166, ET 26	Ø 155	11W	1350lm	IP44	99209	9 002759 992095
steel, black / plastic, white Stahl, schwarz / Kunststoff, weiss acier, noir / plastique, blanc	Ø 166, ET 26	Ø 155	11W	1350lm		99144	9 002759 991449
	Ø 166, ET 26	Ø 155	11W	1350lm	IP44	99212	9 002759 992125
	Ø 166, ET 26	Ø 155	11W	1350lm		99158	9 002759 991586
	Ø 166, ET 26	Ø 155	11W	1350lm	IP44	99214	9 002759 992149

RECESSED DOWNLIGHTS - FUEVA
245

TABLE
TABELLE
TABLEAU

Some products have the same appearance and only differ in terms of technical data or functions such as light colour, dimmability, IP class, etc. These are shown in a table for a better overview.

Einige Produkte haben die selbe Optik und unterscheiden sich nur durch technische Daten oder Funktionen wie: Lichtfarbe, Dimmbarkeit, IP-Klasse, etc. Diese werden für den besseren Überblick in einer Tabelle dargestellt.

Certains produits ont la même apparence et ne diffèrent qu'en termes de données techniques ou de fonctions, telles que la couleur de la lumière, la possibilité de gradation, la classe IP, etc. Pour une meilleure vue d'ensemble, ils sont présentés dans un tableau.

The new energy label must be indicated on all light sources with a luminous flux between 60 and 82,000 lumens and LED. This applies to lamps, LED modules and luminaires where the light source cannot be removed without destroying it.

Das neue Energielabel muss auf allen Lichtquellen mit einem Lichtstrom zwischen 60 und 82.000 Lumen und LED angegeben werden. Dies gilt für Lampen, LED-Module und Leuchten, bei denen die Lichtquelle nicht zerstörungsfrei entnommen werden kann.

Le nouveau label énergétique doit être indiqué sur toutes les sources lumineuses dont le flux lumineux est compris entre 60 et 82 000 lumens et sur les LED. Cela s'applique aux lampes, aux modules LED et aux luminaires dont la source lumineuse ne peut être retirée sans être détruite.

The information on the label includes: / Die Angaben auf dem Etikett beinhalten: / Les informations figurant sur l'étiquette sont les suivantes :

- › Name/Trademark
Name/Warenzeichen
Nom/marque de commerce
- › Model / Modell / Modèle
- › Energy label scale A-G / Energielabel-Skala A-G / Échelle d'étiquetage énergétique A-G
- › Energy consumption for 1,000 hours of use / Energieverbrauch bei 1.000 Stunden Nutzung / Consommation d'énergie pour 1 000 heures d'utilisation
- › Energy efficiency class of the product / Energieeffizienzklasse des Produkts / Classe d'efficacité énergétique du produit
- › QR Code to EPREL (Product Database of the European Product Registry for Energylabelling) / QR Code zur EPREL (Produktdatenbank der European Product Registry for Energylabelling) / Code QR pour EPREL (base de données des produits du registre européen des produits pour l'étiquetage énergétique)

The energy spectrum ranges from G to A.
Das Energiespektrum reicht von G bis A.

Le spectre énergétique va de G à A.



















LEGEND

PICTOGRAM



























































PIKTOGRAMME

PICTOGRAMME

SOCKETS FASSUNGEN DOUILLES

 LED	 G4	 G53
 2G7	 G5	 GU5,3 / MR16
 2G11	 G9	 GU10
 2GX13	 G10Q	 GX53
 E14	 G13	 GY6,35
 E27	 G23	 R7s

BULBS LEUCHTMITTEL AMPOULES

 E14 / C35	 E27 / A60 Halogen	 E27 / E140 Filament
 E14 / C35f	 E27 / R63 Halogen	 E27 / PS160 Filament
 E14 / D45	 E27 / A60 LED	 E27 / T30 Filament
 E14 / C35f LED	 E27 / A60 Filament	 E27 / T32 Filament
 E14 / D45 Halogen	 E27 / A65 LED	 G4 / T9
 E14 / C35 Halogen	 E27 / A75 Filament	 G4 / LT9
 E14 / T22	 E27 / G45 LED	 G4 / LT14
 E14 / C35 Filament	 E27 / G45 Filament	 G9
 E14 / C37 Filament	 E27 / G80 Filament	 G9 LED
 E14 / C35f Filament	 E27 / G95	 GU10
 E14 / C37f Filament	 E27 / G95 Filament	 GU10 LED
 E14 / P45 LED	 E27 / G125	 GU10 SMD LED
 E14 / P45 Filament	 E27 / G95 LED	 GX53 / LF75
 E14 / P50	 E27 / G200 Filament	LED LED board / LED Platine / LED bord
 E14 / ST48 Filament	 E27 / R63 LED	 MR16
 E14 / ST64 Filament	 E27 / ST48 Filament	 MR16 LED
 E14 / T20 LED	 E27 / ST64 Filament	 R7s / 78mm
 E27 / A60	 E27 / B80 Filament	 R7s / 118mm
 E27 / G90	 E27 / BR150 Filament	 R7s / 78mm LED
 E27 / QR63	 E27 / DP165 Filament	 R7s / 118mm LED

LIGHT COLOUR & LUMEN
LICHTFARBE & LUMEN
COULEUR LUMINEUX & LUMEN

The colours of the LED are represented as pictogrammes (see below), their luminous flux directly beneath. The luminous flux is quoted in lumen and describes the amount of light generated by the LED. The higher the value, the brighter is the lamp. Lumens are LED boards and are the light measurement value in bulbs.

Die Farben der LED werden als Piktogramm (siehe unten) dargestellt, deren Lichtstrom direkt darunter. Der Lichtstrom wird in Lumen gemessen und gibt die erzeugte Lichtmenge der LED an. Je höher der Wert, desto heller das Produkt. Lichtstromangaben (Lumen) sind Platinen- bzw. Leuchtmittelwerte.

Les couleurs de LED ont représentés sous forme de pictogrammes, leur flux lumineux directement en dessous. L'unité de flux lumineux est le lumen et il mesure la quantité de lumière générée par les LED. Plus la valeur est élevée, plus la lampe est lumineuse. Les lumens sont l'unité de mesure de l'intensité lumineuse des ampoules et des panneaux led intégrés.

	RGB RGB RGB
	RGB + white RGB + weiß RGB + blanc
	RGB + warmwhite RGB + warmweiß RGB + blanc chaud
	RGB + coldwhite RGB + kaltweiß RGB + blanc froid
	RGB + neutralwhite RGB + neutralweiß RGB + blanc neutrale

	RGB + tunable white RGB + tunable white RGB + tunable white
	tunable white tunable white tunable white
	warm white warmweiß blanc chaud
	cold white kaltweiß blanc froid
	neutral white neutralweiß blanc neutrale

SWITCHES & SENSORES
SCHALTER & SENSOREN
INTERRUPTEUR & CAPTEURS

	incl. cable & plug inkl. Kabel & Stecker câble & connecteur inclus
	internal dimmer eingebauter Dimmer variateur intégré
	button switch Druckknopf interrupteur de pression
	function switch Funktionsschalter interrupteur fonction
	rocker switch Wippschalter interrupteur à bascule
	pedal dimmer Trittdimmer variateur à pied

	pedal switch Trittschalter interrupteur à pied
	cable switch Kabelschalter interrupteur à câble
	incl. cable & plug transformer inkl. Kabel & Stecktransformator câble & transformateur à prise
	remote control Fernbedienung télécommande
	Day & Night Sensor Tag & Nacht Sensor sensor jour & nuit
	sensor Sensor sensor

	swedish plug Stecker Schweden connecteur swede
	"Touch me" ON/OFF "Touch me" EIN/AUS "Touch me" ON/OFF
	"Touch me" ON/OFF & dimm "Touch me" EIN/AUS & Dimmen "Touch me" ON/OFF & graduable
	pull switch Zugschalter interrupteur à bascule
	Timer - automatic on/off Zeitschaltuhr - automatisches Ein- & Ausschalten minuterie - peut être éteint et allumé automatiquement

FUNKTIONS & COMFORT
FUNKTIONEN & KOMFORT
FONCTIONS & COMFORT

	incl. battery inkl. Akku incl. pile
	incl. battery inkl. Batterie incl. pile
	battery specifications Batteriespezifikationen spécifications des piles
	beam angle Ausstrahlwinkel angle de rayonnement
	corner mount possible Eckmontage möglich montage en coin possible
	CRI Colour Rendering Index

	cutout (in mm) Ausschnitt (in mm) perçage du panneau (en mm)
	dimmable dimmbar mit externen Dimmer graduable
	not dimmable nicht dimmbar ne pas graduable
	Can be operated via control unit Bedienbar über Steuergerät Peut être commandé par une unité de contrôle
	replaceable LED austauschbare LED LED remplaçables
	loadable in kg belastbar in kg chargeable en kg

	packaging / delivery unit Verpackungs- / Liefereinheit unité d'emballage / de livraison
	shortable kürzbar réductible
	Voltage Volt Voltage
	Watt
	USB connection USB-Anschluss Connexion USB
	Qi-Charger

PROTECTION CLASS
SCHUTZKLASSE
CLASSE DE PROTECTION

The protection class indicates to what extent the lamp is protected against electric shock. All lamps in this catalogue are at least protected with the protection class 1 - a higher class is specified in the information box of the respective lamp.

Die Schutzklasse gibt an, inwiefern ein Produkt gegen einen elektrischen Schlag gesichert ist. Alle Leuchten in diesem Katalog sind mit mindestens Schutzklasse 1 gesichert, bei höheren Klassen wird das Symbol im Infokasten der Leuchte angegeben.

La classe de protection indique, dans quelle mesure la lampe est protégée contre les chocs électriques. Tous les lampes dans ce catalogue sont protégées au moins avec la classe 1 - une classe plus élevée est indiquée dans l'information de la lampe.

	protection class 1: protective earthing Schutzklasse 1: Schutzerdung classe de protection 1: prise de terre
--	-------------------------------------------------------------------------------------------------------------------

	protection class 2: protective insulation Schutzklasse 2: Schutzisolation classe de protection 2: double isolation ou renforcée
--	---------------------------------------------------------------------------------------------------------------------------------------

	protection class 3: protective low voltage Schutzklasse 3: Schutzkleinspannung classe de protection 3: très basse tension de sécurité
--	---------------------------------------------------------------------------------------------------------------------------------------------

PROTECTION RATING
SCHUTZGRAD
INDICE DE PROTECTION

The protection rating ensures the operational safety of luminaires. The first number specifies the extent of the protection against the ingress of foreign bodies; the second number identifies the humidity protection grade. All luminaires in this catalogue are at least protected with the rating IP20 - a higher rating is specified in the information box of the luminaire.

Der Schutzgrad gewährleistet die Betriebssicherheit von Leuchten. Die erste Ziffer des IP Grades beschreibt den Schutzzumfang gegen das Eindringen von Fremdkörpern, die zweite Ziffer informiert über den Grad des Feuchtigkeitsschutzes. Alle Leuchten in diesem Katalog sind mit mindestens Schutzgrad IP20 gesichert, bei höheren Graden wird das Symbol im Infokasten der Leuchte angegeben.

L'indice de protection assure la sécurité opérationnelle des luminaires. Le premier chiffre indique à quel point la protection est efficace contre l'insertion de corps étrangers; le second chiffre indique quant à lui le degré de protection par rapport à l'humidité. Tous les luminaires dans ce catalogue sont protégés au moins avec l'indice IP20 - un indice plus élevé est indiqué dans l'information d'article.

	IP33
	IP44

	IP54
--	------

	IP65
--	------

	IP67
--	------

REGISTER

ARTICLE NUMBER
ARTIKELNUMMER
NUMÉROS D'ARTICLE

NUMBER NUMMER NUMÉRO	PAGE SEITE PAGE	NUMBER NUMMER NUMÉRO	PAGE SEITE PAGE	NUMBER NUMMER NUMÉRO	PAGE SEITE PAGE	NUMBER NUMMER NUMÉRO	PAGE SEITE PAGE	NUMBER NUMMER NUMÉRO	PAGE SEITE PAGE	NUMBER NUMMER NUMÉRO	PAGE SEITE PAGE	NUMBER NUMMER NUMÉRO	PAGE SEITE PAGE
30761	266	95821	198	98129	148	98844	41	99155	246	99225	263	99643	211
30762	272	95822	198	98201	152	98845	42	99156	241	99226	264	99644	211
30891	266	95823	198	98203	152	98846	41	99157	242	99227	266	99669	21
30892	266	95843	202	98205	153	98847	42	99158	245	99228	263	99671	21
30893	272	95844	202	98206	153	98849	45	99159	246	99229	264	99684	54
30894	272	95846	202	98207	165	98852	45	99162	248	99232	266	99685	54
31683	232	95851	201	98208	165	98854	45	99163	248	99233	263	99686	55
31689	232	95852	201	98209	165	98865	255	99164	251	99234	264	99687	55
32811	149	95853	201	98212	242	98866	255	99167	248	99235	266	99716	292
32812	148	95855	201	98238	204	98867	255	99168	248	99236	268	99717	293
32813	149	95856	201	98241	204	98868	255	99169	251	99237	271	99718	293
32896	203	95857	201	98243	204	98869	255	99178	248	99238	272	99719	293
33107	156	95858	201	98244	204	98871	255	99179	248	99239	268	99721	295
33108	156	95859	201	98292	260	98901	172	99181	251	99241	271	99722	295
33391	207	96081	97	98293	260	98902	172	99183	248	99242	272	99723	295
33394	209	96151	161	98297	152	98903	172	99184	248	99243	268	99724	296
33996	204	96152	160	98301	207	98904	173	99185	251	99244	271	99726	279
33997	207	96153	160	98302	209	98905	173	99187	248	99245	272	99727	279
61355	162	96154	160	98303	207	99038	183	99188	248	99246	268	99728	146
61358	162	96791	286	98304	209	99039	183	99189	251	99247	271	99729	146
61359	163	96792	286	98305	207	99099	15	99191	242	99248	272	99833	168
61361	163	96794	286	98306	209	99106	15	99192	245	99252	268	99834	169
61489	162	96901	210	98307	207	99131	241	99193	246	99253	271	99835	169
93706	97	97079	218	98308	209	99132	242	99202	241	99254	272	99836	169
93707	97	97262	274	98418	154	99133	245	99203	245	99255	268	99841	185
94235	226	97263	274	98419	154	99134	246	99204	241	99256	271	99842	185
94236	226	97264	274	98472	209	99135	241	99205	245	99257	272	110337	89
94237	226	97265	274	98474	209	99136	241	99206	241	99258	264	110338	89
94239	228	97266	274	98571	292	99137	242	99207	245	99259	266	110339	86
94242	228	97267	274	98572	292	99138	245	99208	241	99263	264	110341	86
94406	231	97268	274	98573	294	99139	246	99209	245	99264	266	110342	86
94407	231	97269	274	98574	294	99141	241	99211	241	99265	266	110343	90
94408	231	97271	274	98607	204	99142	241	99212	245	99266	266	110344	90
94496	284	97279	274	98609	207	99143	242	99213	241	99267	266	110345	91
94497	284	97501	164	98611	209	99144	245	99214	245	99268	272	110346	91
94499	284	97502	164	98633	252	99145	246	99215	263	99269	272	110347	87
94501	282	97503	164	98634	252	99146	241	99216	264	99271	272	110348	87
94502	282	97571	95	98635	252	99147	241	99217	266	99337	278	110349	90
94503	283	97572	94	98637	222	99148	242	99218	263	99338	278	900044	34
94504	282	97573	94	98639	222	99149	245	99219	264	99493	204	900045	34
95359	233	97574	94	98766	155	99151	246	99221	266	99494	204	900046	34
95817	198	97927	296	98767	155	99152	241	99222	263	99548	30	900047	35
95818	198	97928	296	98842	41	99153	242	99223	264	99549	30	900048	35
95819	198	98025	149	98843	42	99154	245	99224	266	99639	30	900049	36

NUMBER NUMMER NUMÉRO	PAGE SEITE PAGE	NUMBER NUMMER NUMÉRO	PAGE SEITE PAGE	NUMBER NUMMER NUMÉRO	PAGE SEITE PAGE	NUMBER NUMMER NUMÉRO	PAGE SEITE PAGE	NUMBER NUMMER NUMÉRO	PAGE SEITE PAGE	NUMBER NUMMER NUMÉRO	PAGE SEITE PAGE	NUMBER NUMMER NUMÉRO	PAGE SEITE PAGE
900051	36	900486	24	900745	207	900967	215	901467	47	901571	75	901711	127
900052	36	900487	24	900746	207	900968	215	901468	48	901572	81	901753	120
900053	37	900558	180	900747	207	900969	215	901469	48	901573	81	901754	124
900054	26	900559	180	900748	201	901011	264	901471	50	901574	82	901755	224
900055	26	900561	180	900749	201	901012	266	901472	50	901575	83	901756	224
900056	26	900568	170	900751	228	901013	264	901473	50	901576	80	901757	224
900057	32	900569	170	900752	229	901014	266	901474	51	901577	81	901758	225
900058	32	900571	178	900753	227	901043	280	901475	51	901578	82	901759	225
900059	32	900572	178	900754	227	901044	280	901476	49	901579	83	901761	225
900061	33	900573	178	900758	28	901108	52	901477	49	901638	105		
900062	33	900574	290	900759	28	901109	52	901524	78	901639	105		
900095	37	900575	290	900761	29	901117	196	901525	78	901641	109		
900099	38	900576	290	900762	29	901118	196	901526	79	901642	109		
900101	38	900577	291	900763	17	901167	192	901527	78	901644	108		
900102	41	900578	291	900764	16	901168	18	901528	79	901645	105		
900103	42	900579	291	900765	17	901169	18	901529	79	901646	108		
900104	45	900581	263	900766	16	901191	182	901537	70	901647	106		
900105	38	900582	263	900815	234	901192	183	901541	60	901648	106		
900106	38	900583	263	900816	235	901438	136	901542	60	901651	106		
900107	41	900584	264	900817	150	901439	136	901543	60	901652	104		
900108	42	900585	266	900818	150	901441	136	901544	61	901653	104		
900109	45	900586	268	900819	151	901442	137	901545	62	901654	111		
900111	38	900587	271	900821	151	901443	137	901546	62	901655	111		
900112	38	900588	272	900822	151	901444	138	901547	62	901656	115		
900113	41	900589	268	900912	194	901445	138	901548	63	901657	115		
900114	42	900591	271	900913	195	901446	140	901549	63	901659	114		
900115	45	900592	272	900914	194	901447	140	901551	65	901661	111		
900116	15	900593	268	900915	195	901448	140	901552	65	901662	114		
900181	264	900594	271	900931	255	901449	141	901553	65	901663	112		
900182	266	900595	272	900932	255	901451	141	901554	66	901664	112		
900183	271	900637	263	900933	255	901452	139	901555	66	901666	112		
900184	272	900638	263	900934	255	901453	139	901556	67	901667	110		
900251	210	900639	263	900935	255	901454	142	901557	67	901668	110		
900451	235	900641	264	900936	255	901455	142	901558	68	901669	120		
900452	236	900643	268	900937	158	901456	143	901559	68	901683	122		
900453	236	900644	271	900938	158	901457	143	901561	68	901684	122		
900454	235	900646	268	900939	158	901458	144	901562	69	901685	122		
900455	237	900647	271	900959	174	901459	144	901563	69	901686	123		
900456	237	900649	268	900961	174	901461	145	901564	70	901687	123		
900481	22	900651	271	900962	212	901462	145	901565	70	901691	124		
900482	22	900653	264	900963	213	901463	46	901566	74	901706	126		
900483	22	900654	264	900964	213	901464	46	901567	74	901707	126		
900484	23	900743	198	900965	213	901465	46	901568	74	901708	126		
900485	23	900744	198	900966	214	901466	47	901569	75	901709	127		

REGISTER

SERIES NAMES
SERIENNAMEN
NOME DE PRODUITS

NAME NAME NOM	PAGE SEITE PAGE	NAME NAME NOM	PAGE SEITE PAGE	NAME NAME NOM	PAGE SEITE PAGE
ALBARCA	174	FAVAZZINA	224-225	SALOBRENA-A	152-153
AMMONIAK	70	FERREROS	286	SALOBRENA-B	155
APPRODO	78-79	FLEXIBLE STRIPE	292-296	SALOBRENA-M	154
AREITIO	222	FUEVA 1	252, 274	SALOBRENA-RGBW	156
ARENALS	192	FUEVA 5	241-251, 263-272	SALOBRENA-Z	34-37
BALAZOTE	182-183	FUEVA FLEX	255	SARSINA	164
BASIC	60-61	FUEVA-A	242, 260	SARSINA-A	165
BASIC PLUS	62-63	FUEVA-Z	38-45	SARSINA-Z	28-29
BOHOYO	280	HERRORA-Z	30	SARTIANO	203
BORDONARA	178	KOB LED	97	SAVATARILA	183
CALONGE	194-195	LAZARAS	185	SICCIAROTTA	75
CALONGE RGB	196	LED STRIPE-Z	54-55	SLIM	65
CAROSSO	234-237	LED STRIPES-FLEX	296	SLIM CCT	66
CAROSSO-Z	16-18	LM_LED_G13	86-91	SLIM SENSOR	67
CHANGO	218	MARGIDORE	79	SUSPENSION	70
COB STRIPE	290-291	MARMORATA	180	TEDO	232
CONNECT Z	15	MATTANZA	74	TEDO 1	233
CONNECT-Z SENSOR	15	MECINOS	211	TEYA	97
CONNECT-Z SWITCH	15	MINERARIO	80-83	TPLUS 6 LENS SPOT	123, 127
CRESPILLO	278-279	NEON-STRIFE-Z	52	TPLUS EXTENSION	120, 124
DUNDRY	94-95	PADROGIANO-Z	22-24	TPLUS FLAT LIGHT	122, 126
EASY FIX	68	PENETO	226-231	TPLUS PENDANT	123, 127
EASYT CONNECTOR	109, 115	PINEDA	198-202	TPLUS SLIM SPOT	122, 126
EASYT CORNER	109, 115	POLASSO	282-284	TPLUS STARTER SET	120, 124
EASYT DEPORTED CON	105, 111	PRIME	69	TPLUS WIDE SPOT	122, 126
EASYT E27 ADAPTER	108, 114	RABASSA	158	TRUPIANA	170
EASYT FEEDER	105, 111	RAPITA	212-215	TURCONA	172-173
EASYT PENDANT	106, 112	ROVITO	136-141	TURCONA-CCT	168-169
EASYT SET 3 SPOTS	104, 110	ROVITO-R	142-145	TURCONA-Z	26, 32-33
EASYT SET 4 SPOTS	104, 110	ROVITO-Z	46-51	URTEBIETA	146
EASYT SPOT RING	106, 112	SALABATE	204	ZARATE	210
EASYT SPOT TUBE	106, 112	SALICETO	204, 207, 209		
EASYT SUSPENSION	108, 114	SALICETO-Z	21		
EASYT TRACK	105, 111	SALOBRENA 1	148-151, 160-163		



NOTES

NOTIZEN
NOTES



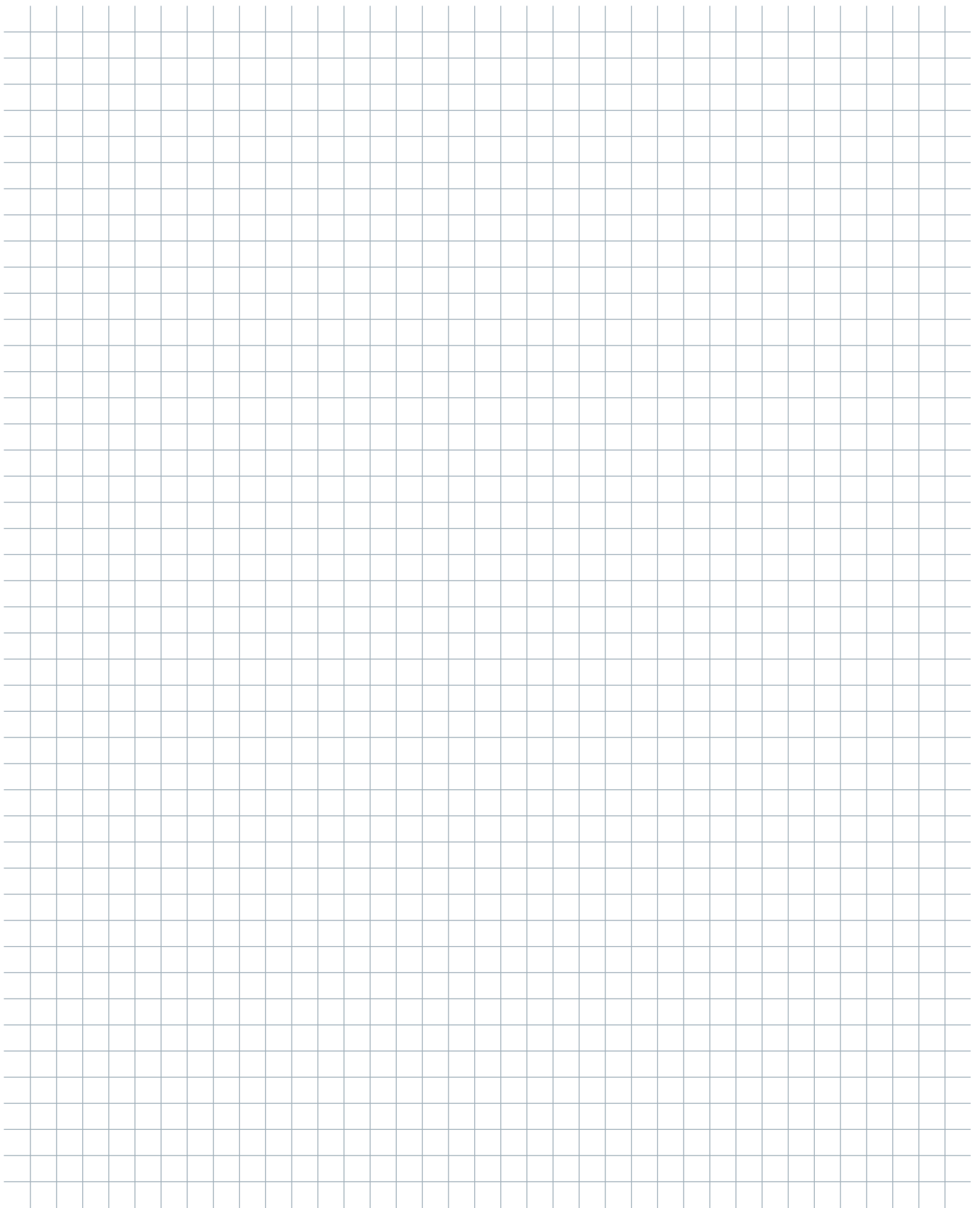

NOTES

NOTIZEN
NOTES



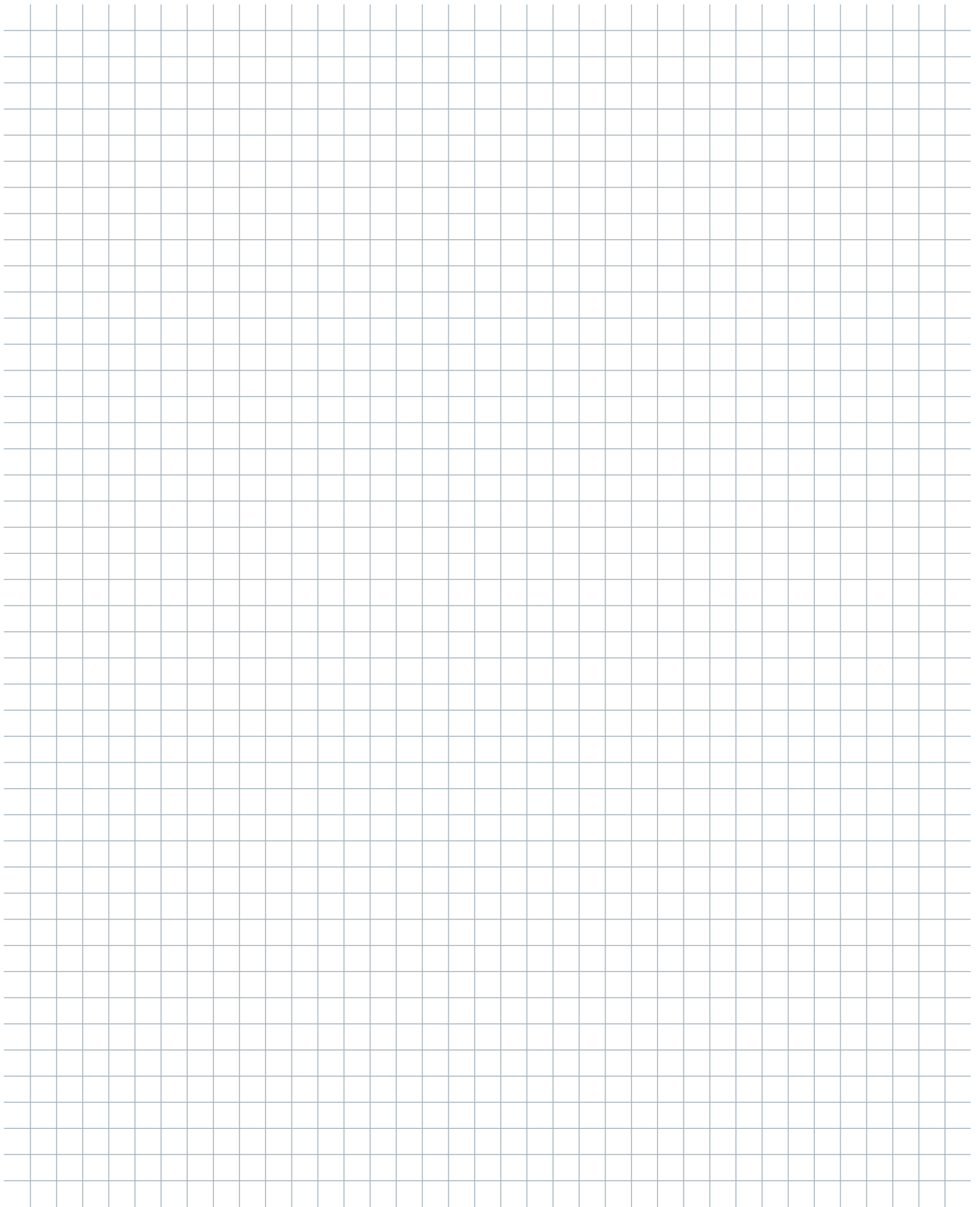



All previous catalogues and price lists are no longer valid with the issue of this catalogue. Errors, misprints, model and price changes and technical modifications are reserved. We deliver based on our terms of delivery and payment. Our products comply with the European light norm EN60598. Products with the ENEC test mark are conforming to the guide line 2006/95/EG. Products with additional safety remarks (e.g protection class, IP) are identified within the product family with the relevant symbol and number. The content of this catalogue is protected under copyright law for EGLO Leuchten GmbH. All rights reserved. Our specific written consent must be obtained before using any illustrations and texts. The pictures are 4C prints and may differ from the original. The product pictures and ambiences in this catalogue can deviate from reality, and they do not necessarily concur with the usual application of the product. EGLO does not assume liability for the correctness, completeness or the application depiction of the products and/or the product information.

Design, layout and composition:
EGLO GmbH, 6136 Pill - AUSTRIA
Print: Samson Druck GmbH, 5581 St. Margarethen - AUSTRIA
Pictures: EGLO, Adobe Stock, istockphoto.com, shutterstock.com

Mit diesem Katalog verlieren alle vorhergehenden Kataloge und Preislisten ihre Gültigkeit. Irrtümer, Druckfehler, Modell- und Preisänderungen sowie technische Änderungen vorbehalten. Wir liefern zu unseren Liefer- und Zahlungsbedingungen. Unsere Produkte entsprechen der europäischen Leuchtnorm EN 60598. Produkte mit dem ENEC Prüfzeichen sind konform mit der Richtlinie 2006/95/EG. Produkte mit weiteren Sicherheitshinweisen (zB. Schutzklasse, IP) sind mit Symbol und Zahl bei der Produktfamilie ausgezeichnet. Der Inhalt dieses Kataloges ist für die EGLO Leuchten GmbH urheberrechtlich geschützt. Alle Rechte sind vorbehalten. Bilder und Texte dürfen nicht ohne vorherige ausdrückliche, schriftliche Genehmigung verwendet werden. Die Abbildungen sind 4C Drucke und können vom Original abweichen.

Die Katalogbilder und die gezeigten Darstellungen der Produkte können von der Wirklichkeit abweichen und nicht den üblichen Produktanwendungen entsprechen. EGLO übernimmt keine Haftung für die Richtigkeit, Vollständigkeit und Anwendungsdarstellung der Produkte und Produktinformationen.

Gestaltung, Layout und Satz:
EGLO GmbH, A-6136 Pill - AUSTRIA
Druck: Samson Druck GmbH, 5581 St. Margarethen - AUSTRIA
Bilder: EGLO, Adobe Stock, istockphoto.com, shutterstock.com

Le présent catalogue remplace tous les catalogues et tarifs précédents. Sous réserve d'erreurs, de fautes d'impression, de modification des modèles et de changement de prix et de technique. Nous livrons sur la base de nos conditions de livraison et de paiement. Nos produits sont conformes aux normes européennes EN 60598 et portent le marquage CE. Les produits portant la marque ENEC sont conformes à la Directive 2006/95/EG. Les produits portant d'autres indications de sécurité (par exemple classe de protection, IP) sont identifiés par le symbole et le nombre correspondants dans la famille de produits.

Le contenu du présent catalogue est protégé pour la société EGLO Leuchten GmbH par un copyright. Tous droits réservés. Toute reproduction d'images et du texte est interdite sans autorisation explicite par écrit préalable. Les images sont imprimées en 4C et peuvent différer de l'original.

Les images des produits et les ambiences dans le catalogue peuvent dévier de la réalité et ne sont pas nécessairement en ligne avec l'usage habituel du produit. EGLO n'engage pas sa responsabilité sur la justesse des images et sur les informations relatives à l'usage pouvant être fait des produits.

Conception, maquette et composition :
EGLO GmbH, A-6136 Pill - AUSTRIA
Presse: Samson Druck GmbH, 5581 St. Margarethen - AUSTRIA
Images: EGLO, Adobe Stock, istockphoto.com, shutterstock.com

04-2024

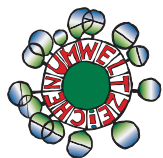

printed according to the Austrian Ecolabel criteria for printed matter, UW-Nr. 837

gedruckt nach der Richtlinie "Druckerzeugnisse" des Österreichischen Umweltzeichens, UW-Nr. 837

imprimé selon la directive „Produits imprimés du label écologique autrichien, UW-Nr. 837





EGLO Leuchten GmbH
Heiligkreuz 22
A-6136 Pill
Austria
Tel. +43 (0) 5242 6996
Fax +43 (0) 5242 6996-972
info@eglo.com
www.eglo.com

KATTLIS24



my light | my style