



ITALIAN DESIGN LIGHTING

LUCE *da* VIVERE



ITALIAN DESIGN LIGHTING

LUCE *da* VIVERE



E' da un nuovo modo di interpretare la luce da cui nasce "Luce da vivere" il nuovo pay-off di IDL® Italian Design Lighting. Design innovativo e un assoluto equilibrio estetico, unitamente a linee funzionali ed espressive, si rivelano capaci di adattarsi alle migliori soluzioni e agli spazi del living odierno, diventando sinonimo di un inconfondibile stile di vita.

Gli oggetti illuminanti di "Luce da vivere" rispecchiano l'artigianalità e la professionalità dettata dalla sapienza con cui IDL® Italian Design Lighting crea le proprie opere con trentennale esperienza. E' grazie alle idee, all'entusiasmo e alla passione unitamente alla capacità di creare con la luce, che lo staff di IDL è alla continua ricerca di soluzioni all'avanguardia che possano prendere forma e diventare oggetti atti a brillare di sensazioni ed emozioni, secondo i più accurati processi lavorativi e di controllo qualitativo.

"Luce da vivere" by IDL® Italian Design Lighting è autentica garanzia dell'indiscusso fascino e del puro design Made in Italy.

It's a new way to interpret the light which comes from "Luce da vivere", the new pay-off of IDL® Italian Lighting Design.

Innovative design and an absolute aesthetic equilibrium, along functional and expressive lines, guarantee an unmistakable choice of style, they become capable of adapting to the best solutions and living spaces of today, becoming synonymous with a unique lifestyle.

The illuminating objects by "Luce da vivere" reflect the craftsmanship and professionalism dictated by the knowledge with which IDL® Italian Lighting Design created their works with thirty years experience. And thanks to the ideas, enthusiasm and passion with the ability to create with light, which the staff of IDL is constantly looking for solutions that can take shape and become capable of shining objects of sensations and emotions, according to the most accurate work processes and quality control.

"Luce da vivere" by IDL® Italian Lighting Design is the undisputed guarantee of the authentic charm and pure design Made in Italy.



emotion PAGE 4



bubbles PAGE 12



planets PAGE 24



bamboo PAGE 30



bouquet PAGE 40



girasole PAGE 48



tuberosa PAGE 54



glossy PAGE 60



ice cube PAGE 68



mary PAGE 74



artesia PAGE 80

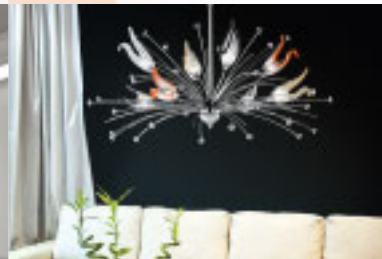

tulipe PAGE 86



fleurs PAGE 92



flute PAGE 98

DESIGN *cristian feltrin*
emotion



Nasce da forme lineari e pulite la collezione "Emotion", dove le rigorose linee dei metalli al laser, incastonate di cristalli Swarovski, mettono in risalto gli effetti di luce, che da essi traspaiono e accendono di luce riflessa i preziosi bastoncini in Vetro di Murano posti alle estremità, come per incoronare i corpi illuminanti, atti proprio a regalare suggestive emozioni.

The collection "Emotion" was created by linear forms and clean, where the strict lines of metals by laser, which are set Swarovski crystals, highlighting the effects of light, that shines through them and turn the light reflected precious sticks of Murano Glass at the ends, as to crown the luminaries, their acts to give suggestive emotions.

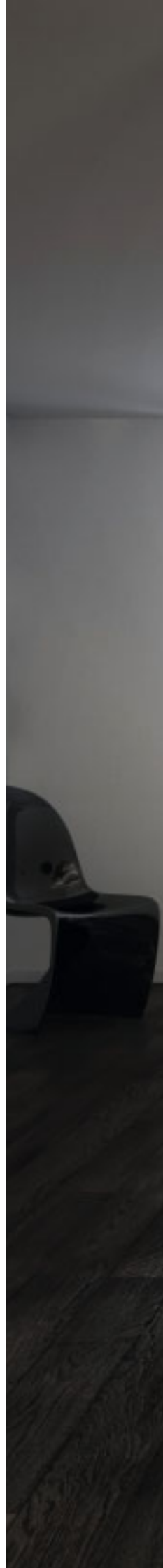



421/60 *sospensione suspension*



421/70PF plafoniera ceiling lamp

421/50PF plafoniera ceiling lamp



421/18 *sospensione suspension*





421/30 *sospensione suspension*



421/45 *sospensione suspension*



421/2A *applique wall bracket*



421/1L *lampada tavolo table lamp*



421/1P *piantana floor lamp*



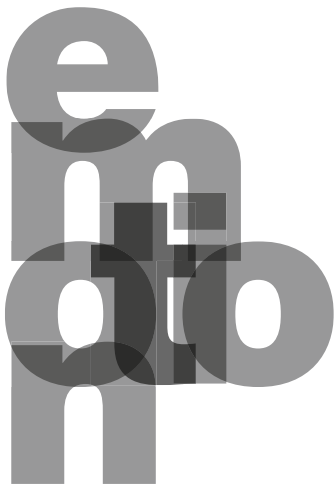

emotion DESIGN *cristian feltrin*

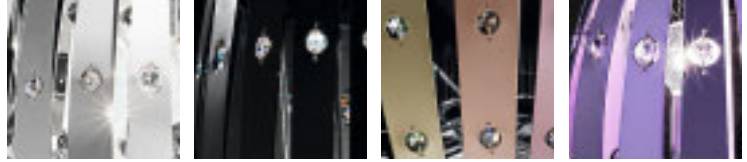

cromo
chrome

nero
black

multicolore
multicolour

viola
violet

EMOTION LUXURY

Telaio principale in metallo cromato. Inserti in metallo tagliato al laser, disponibili nelle finiture cromo, violet, nero o multicolore. Dettagli in cristallo Swarovski Strass®. Disco diffusore in policarbonato satinato e bastoncini decorativi in vetro di Murano trasparente.



Main frame in chromed metal. Inserts in metal laser-cut, available in chrome finish, violet, black or multicoloured. Details in Swarovski Strass® crystal. Satin polycarbonate diffuser and decorative sticks in transparent Murano glass.

EMOTION CLASSIC

Telaio principale in metallo cromato. Inserti in metallo tagliato al laser, disponibili nelle finiture cromo, violet, nero o multicolore. Dettagli in cristallo Swarovski Strass®. Disco diffusore in policarbonato satinato.

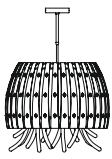

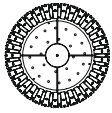
Main frame in chromed metal. Inserts in metal laser-cut, available in chrome finish, violet, black or multicoloured. Details in Swarovski Strass® crystal. Satin polycarbonate diffuser.

63 •  • 50/93 •
421/60
sospensione
suspension

• 60 •  •  •  •
 4 x E27
 MAX 60W
 or 4 x E27
 MAX 24W

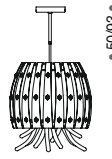

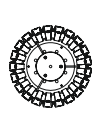
• CE ⊕ ▽

56 •  • 50/93 •
421/45
sospensione
suspension

• 45 •  •  •  •
 3 x E27
 MAX 60W
 or 3 x E27
 MAX 24W

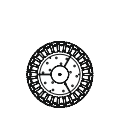

• CE ⊕ ▽

50 •  • 50/93 •
421/30
sospensione
suspension

• 34 •  •  •  •
 1 x E27
 MAX 100W
 or 1 x E27
 MAX 24W

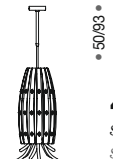

• CE ⊕ ▽

65 •  • 50/93 •
421/18
sospensione
suspension

• 24 •  •  •  •
 1 x E27
 MAX 60W
 or 1 x E27
 MAX 24W

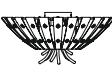

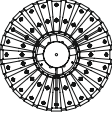
• CE ⊕ ▽

40 •  •
421/70PF
plafoniera
ceiling lamp

• 70 •  •  •  •
 4 x E27
 MAX 40W
 or 4 x E27
 MAX 24W

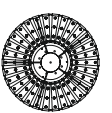

• CE ⊕ ▽

37 •  •
421/50PF
plafoniera
ceiling lamp

• 50 •  •  •  •
 4 x E14
 MAX 40W
 or 4 x E14
 MAX 9W

• CE ⊕ ▽

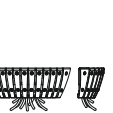
30 •  •
421/2A
applique
wall bracket

• 45 •  •  •  •
 2 x E14
 MAX 60W
 or 2 x E14
 MAX 9W



• CE ⊕ ▽

41 •  •
421/1L
lampada tavolo
table lamp

• 17 •  •  •  •
 1 x E14
 MAX 40W
 or 1 x E14
 MAX 9W

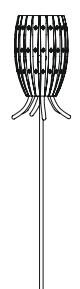
• CE ⊕ ▽

179 •  •
421/1P
piantana
floor lamp

• 33 •  •  •  •
 1 x E27
 MAX 100W
 or 1 x E27
 MAX 24W

• CE ⊕ ▽

DESIGN *IDL design staff*
bubbles

A un soffio di migliaia di bolle s'ispira la collezione "Bubbles", dove la lavorazione del metallo è tale da trasformarlo in qualcosa di soffice e sospeso, sostenuto solamente dalla luce che lo fa brillare, in un'atmosfera idilliaca.

For a breath of thousands of bubbles is inspired the collection "Bubbles", where the metal is liable to turn it into something soft, suspended, supported only by the light that makes it shine, in an idyllic atmosphere.





427/6P *piantana* floor lamp

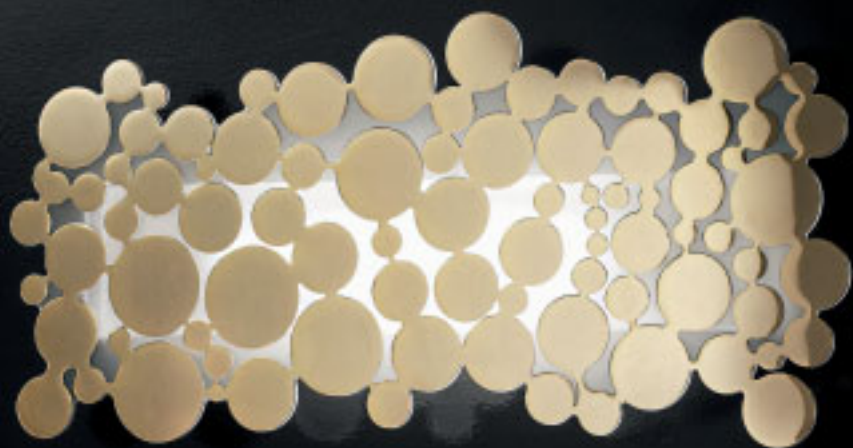
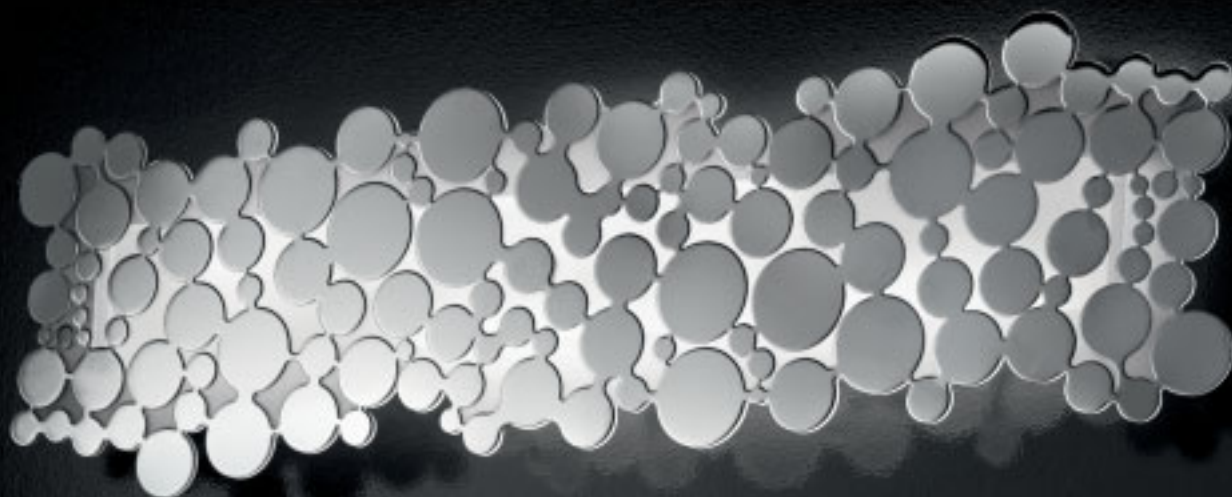

427/2AG plafoniera/applique ceiling lamp/wall bracket

427/1AP plafoniera/applique ceiling lamp/wall bracket

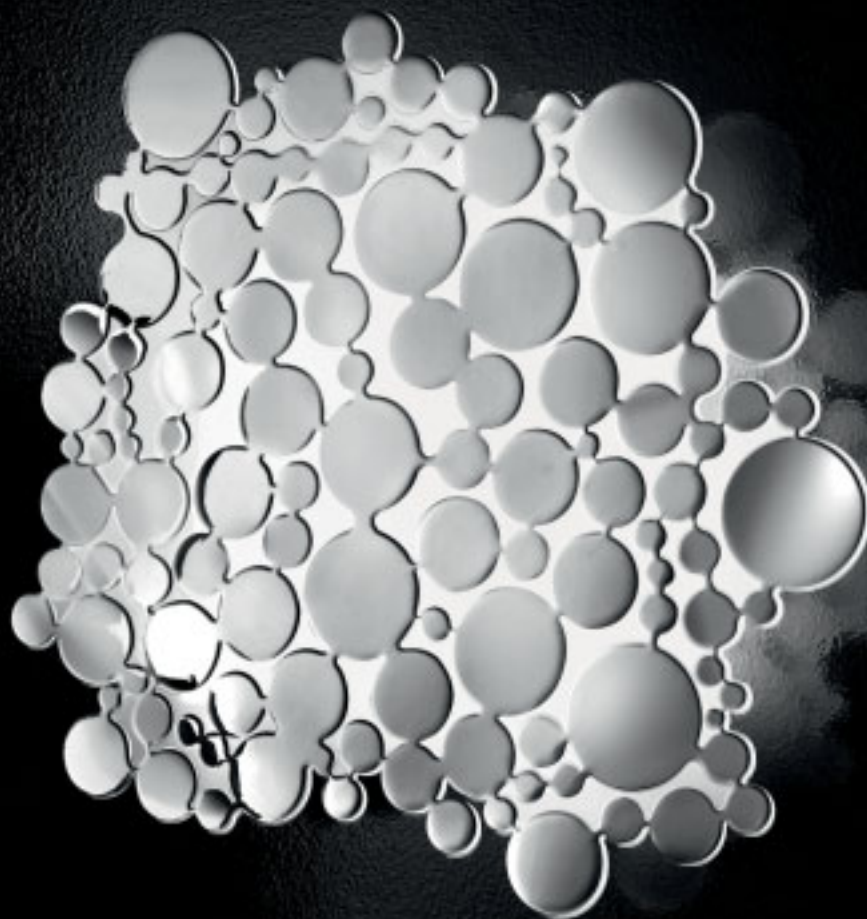

427/1PF plafoniera/applique ceiling lamp/wall bracket



427/5 *sospensione suspension*



427/6 *sospensione suspension*



427/1SP *sospensione suspension*



427/1SM *sospensione suspension*



427/10PF *plafoniera ceiling lamp*



441/12S *sospensione suspension*

441/1LP *lampada tavolo table lamp*

441/1L *lampada tavolo table lamp*





441/1SP *sospensione suspension*

441/6S *sospensione suspension*

441/1S *sospensione suspension*



427/L lampada tavolo table lamp



427/6P piantana floor lamp

bubbles

bubbles DESIGN IDL design staff



cromo
chrome

oro chiaro
light gold

Telaio in metallo cromato o oro chiaro.

Negli articoli 427/1AP, 427/2AG, 427/1PF diffusore in policarbonato satinato.

Frame in chromed metal or light gold.

In articles 427/1AP, 427/2AG, 427/1PF satin polycarbonate diffuser.

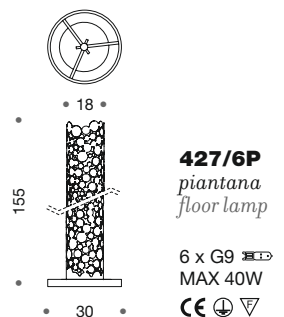
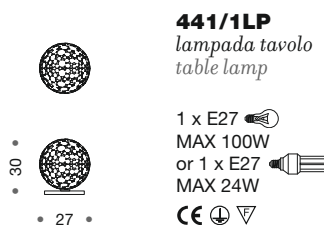
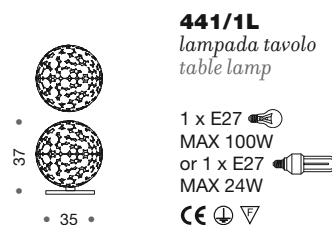
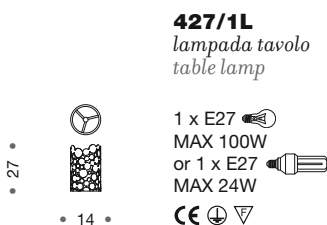
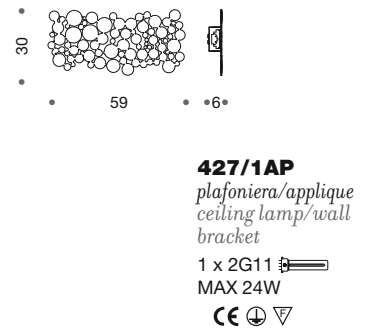
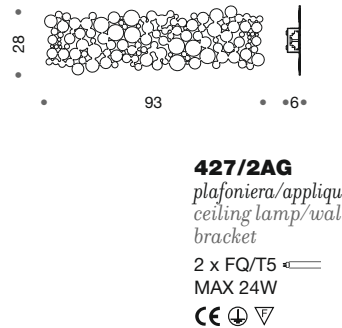
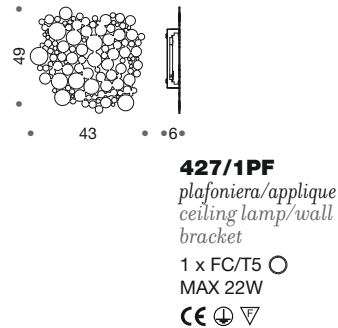
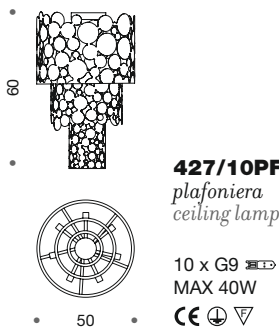
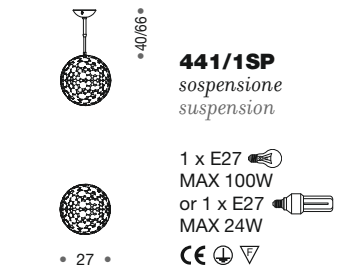
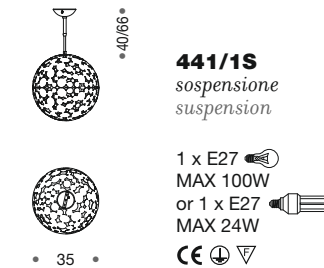
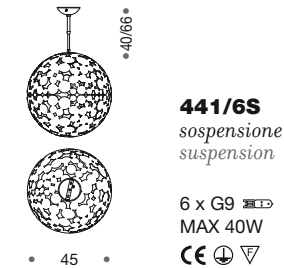
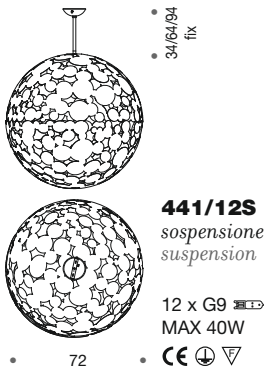
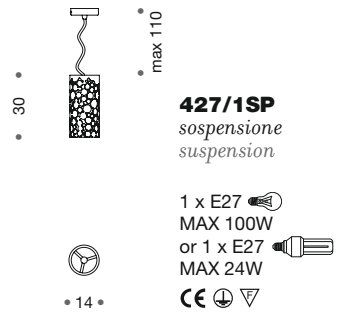
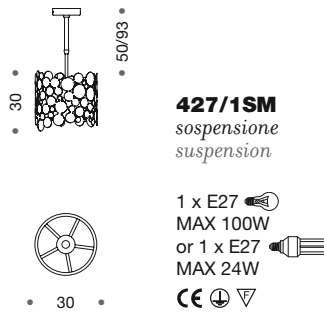
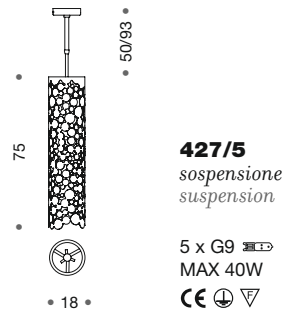
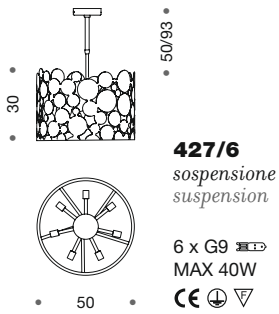

DESIGN *nicola design***planets**

Design deciso e originale per "Planets", una collezione semplicemente innovativa, sobria nei materiali usati, dona originalità agli ambienti e si rende complice a un ritratto estremamente moderno ma dal gusto anche un po' retrò.

Original and decided design to "Planets", simply an innovative collection such as sober materials used, gives originality to the surroundings and makes an accomplice to a very modern portrait taste but also a little "retrò".





438/18 *sospensione suspension*



438/12P *piantana floor lamp*



438/12PF *plafoniera ceiling lamp*



438/8 *sospensione suspension*



438/2A LED *applique wall bracket*

438/4A *applique wall bracket*

438/5L *lampada tavolo table lamp*

planets

planets DESIGN nicola design

bianco satinato
satin white

Telaio principale in metallo cromato.
Vetro diffusore soffiato bianco satinato.
Braccia in metallo flessibile ricoperte di gomma bianca.
Sfere decorative in ottone cromato di varie dimensioni.
Le basi della piantana e del lume tavolo sono in nickel satinato.
Main frame in chromed metal.
White blown satin glass diffuser.
Flexible metal arms covered in white rubber.
Decorative spheres in chromed brass of various sizes.
The bases of floor lamp and table lamp are in satin nickel.

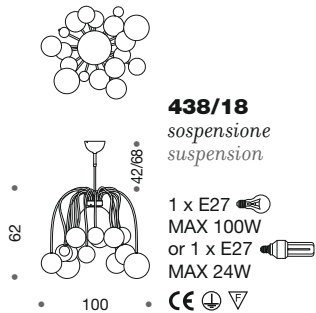

438/18
sospensione
suspension

1 x E27
MAX 100W
or 1 x E27
MAX 24W

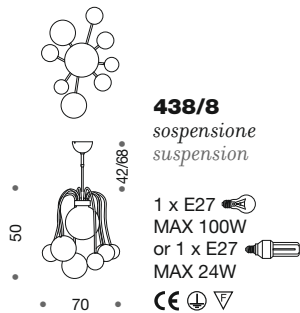

438/8
sospensione
suspension

1 x E27
MAX 100W
or 1 x E27
MAX 24W

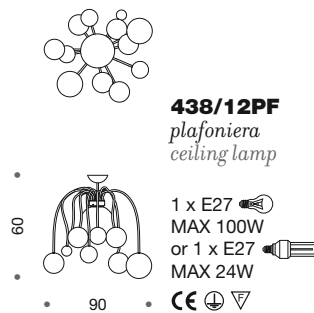

438/12PF
plafoniera
ceiling lamp

1 x E27
MAX 100W
or 1 x E27
MAX 24W

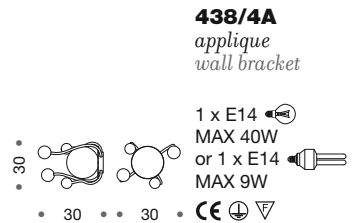

438/4A
applique
wall bracket

1 x E14
MAX 40W
or 1 x E14
MAX 9W

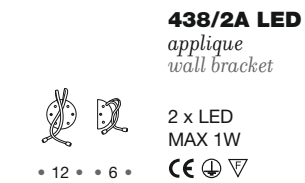

438/2A LED
applique
wall bracket

2 x LED
MAX 1W

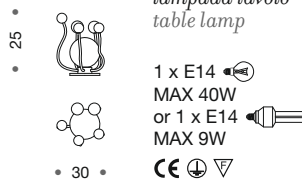

438/5L
lampada tavolo
table lamp

1 x E14
MAX 40W
or 1 x E14
MAX 9W

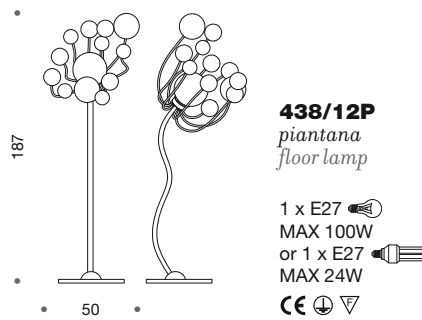

438/12P
piantana
floor lamp

1 x E27
MAX 100W
or 1 x E27
MAX 24W



DESIGN *rizzieri veronese***bamboo**

Note orientali si respirano contemplando la collezione "Bamboo".

Ne deriva la particolare lavorazione del Vetro di Murano, che nelle molteplici sfaccettature, dona brillantezza e riflessi luminosi quasi a rivelare uno spirito unico e magico, nel suo puro e determinato design.

Oriental notes will breathe contemplating the collection "Bamboo".

Hence the special processing of Murano glass, which in many facets, gives shine and reflections of light as if to reveal a unique spirit and magic in its pure and specific design.



bamboo





423/8 *sospensione suspension*





423/6PF plafoniera ceiling lamp



423/8PF plafoniera ceiling lamp



423/3A applique wall bracket

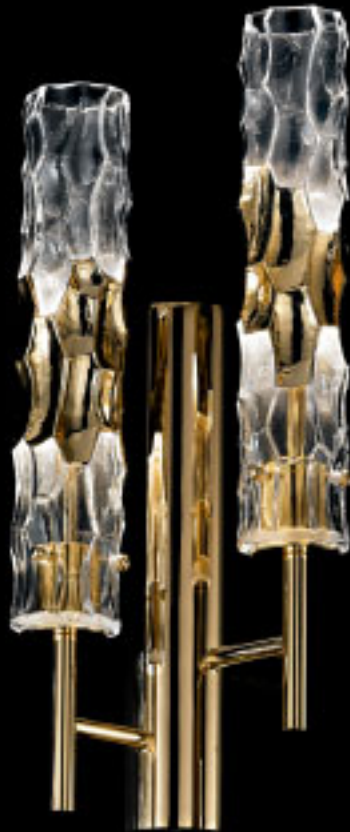

423/2A applique wall bracket



423/1A applique wall bracket



423/6 *sospensione suspension*



423/8 *sospensione suspension*



423/10PF *sospensione suspension*



423/35 *sospensione suspension*





423/3P *piantana floor lamp*



423/3L *lampada tavolo table lamp*



423/1L *lampada tavolo table lamp*

bamboo

bamboo DESIGN *rizzieri veronese*



oro
gold

cromo
chrome

rame
copper

Telaio in metallo disponibile nelle finiture cromo o placcato oro 24kt.

Tubi in vetro di Murano lavorati con effetto martellato e con fascia decorativa metallizzata, disponibile nelle finiture cromo, oro o rame.

Su richiesta, disponibile anche il vetro completamente metallizzato o completamente satinato. Nelle sospensioni a cavo, i cavi sono in acciaio inossidabile.

Metal frame available in chrome finish or 24kt gold plated.

Tubes in Murano glass worked with hammered effect and with metalized decorative band, available in chrome finish, gold or copper.

On request, the glass is available completely metalized or completely satin.

In the suspensions with cables, the cables are in stainless steel.

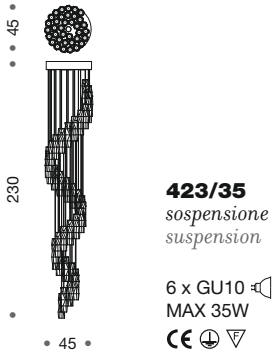

423/35
sospensione
suspension

6 x GU10
MAX 35W
CE ⊕ ▽

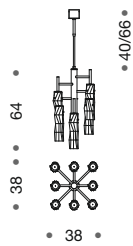

423/8
sospensione
suspension

8 x G9
MAX 25W
CE ⊕ ▽

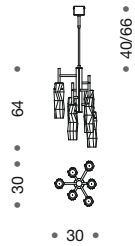

423/6
sospensione
suspension

6 x G9
MAX 25W
CE ⊕ ▽

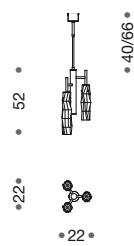

423/3
sospensione
suspension

3 x G9
MAX 25W
CE ⊕ ▽

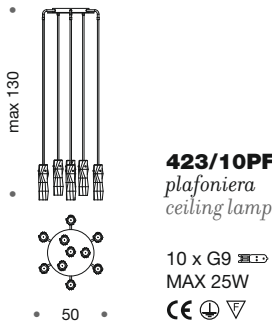

423/10PF
plafoniera
ceiling lamp

10 x G9
MAX 25W
CE ⊕ ▽

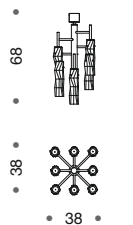

423/8PF
plafoniera
ceiling lamp

8 x G9
MAX 25W
CE ⊕ ▽

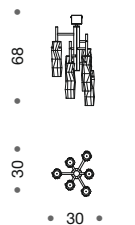

423/6PF
plafoniera
ceiling lamp

6 x G9
MAX 25W
CE ⊕ ▽

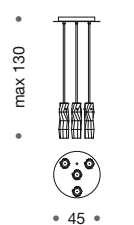

423/4PF
plafoniera
ceiling lamp

4 x G9
MAX 25W
CE ⊕ ▽

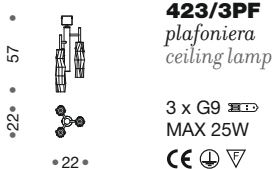

423/3PF
plafoniera
ceiling lamp

3 x G9
MAX 25W
CE ⊕ ▽

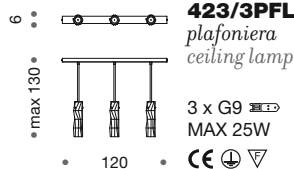

423/3PFL
plafoniera
ceiling lamp

3 x G9
MAX 25W
CE ⊕ ▽

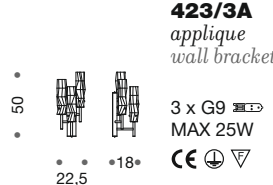

423/3A
applique
wall bracket

3 x G9
MAX 25W
CE ⊕ ▽

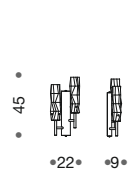

423/2A
applique
wall bracket

2 x G9
MAX 25W
CE ⊕ ▽

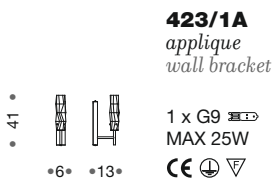

423/1A
applique
wall bracket

1 x G9
MAX 25W
CE ⊕ ▽

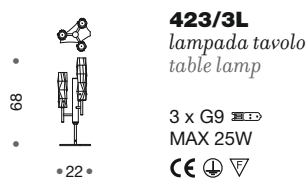

423/3L
lampada tavolo
table lamp

3 x G9
MAX 25W
CE ⊕ ▽

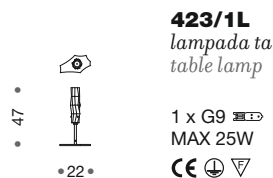

423/1L
lampada tavolo
table lamp

1 x G9
MAX 25W
CE ⊕ ▽

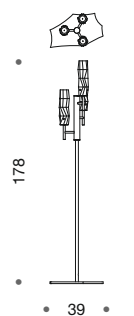

423/3P
piantana
floor lamp

3 x G9
MAX 25W
CE ⊕ ▽

DESIGN *cristian feltrin***bouquet**

Come colta in un meraviglioso giardino, nasce la collezione "Bouquet", dove eleganza e raffinatezza s'incontrano quale connubio di fiori in Vetro di Murano e metalli, rigorosamente interpretati come un vero e proprio dono floreale.

As captured in a beautiful garden, is the collection "Bouquet", where elegance and sophistication come together as a mix of flowers in Murano glass and metals, strictly interpreted as a real floral gift.

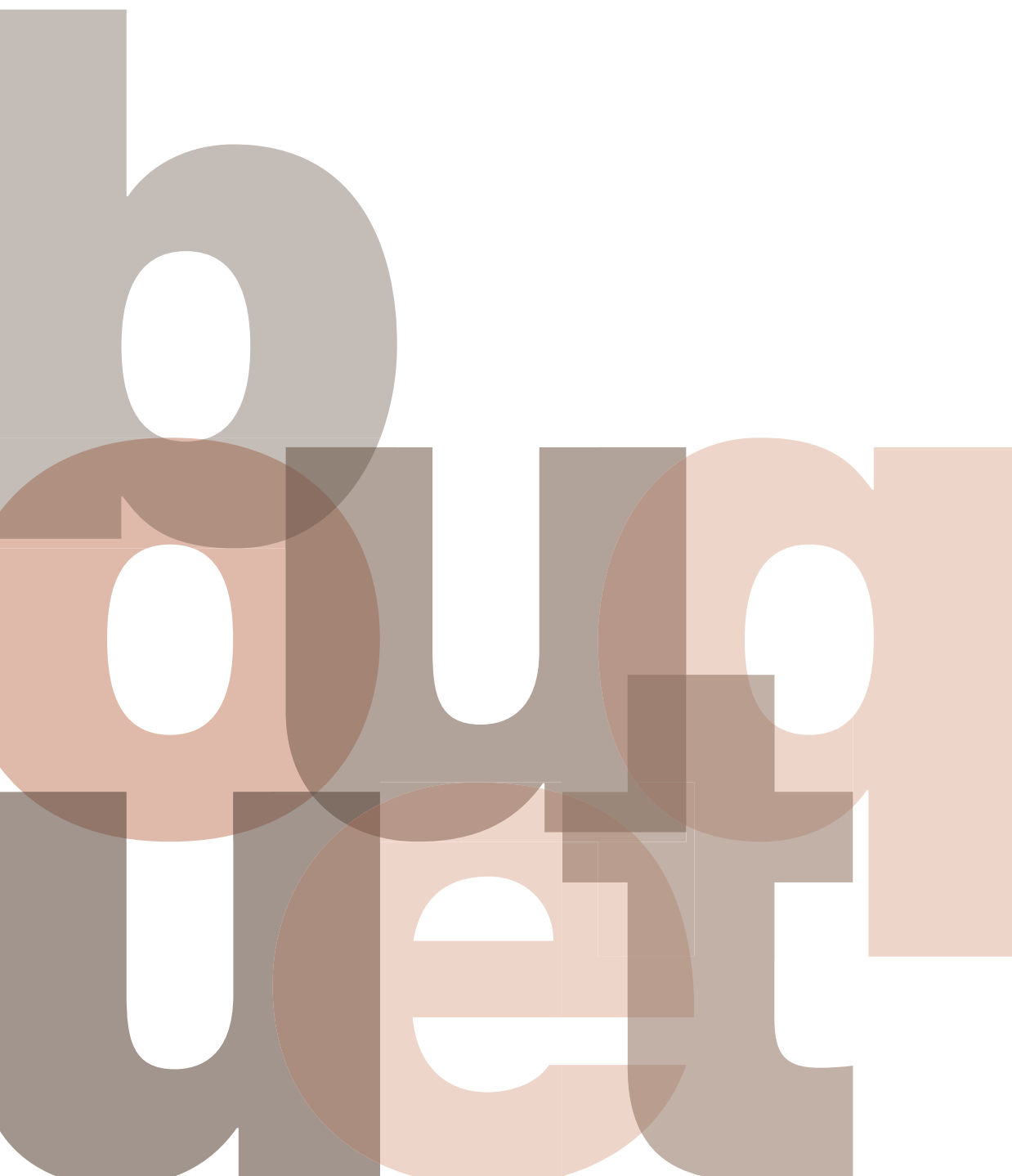



426/8 *sospensione suspension*



426/6PF plafoniera *ceiling lamp*



426/6 *sospensione suspension*

426/8 *sospensione suspension*



426/2L lampada tavolo table lamp

426/2A applique wall bracket

426/1A applique wall bracket

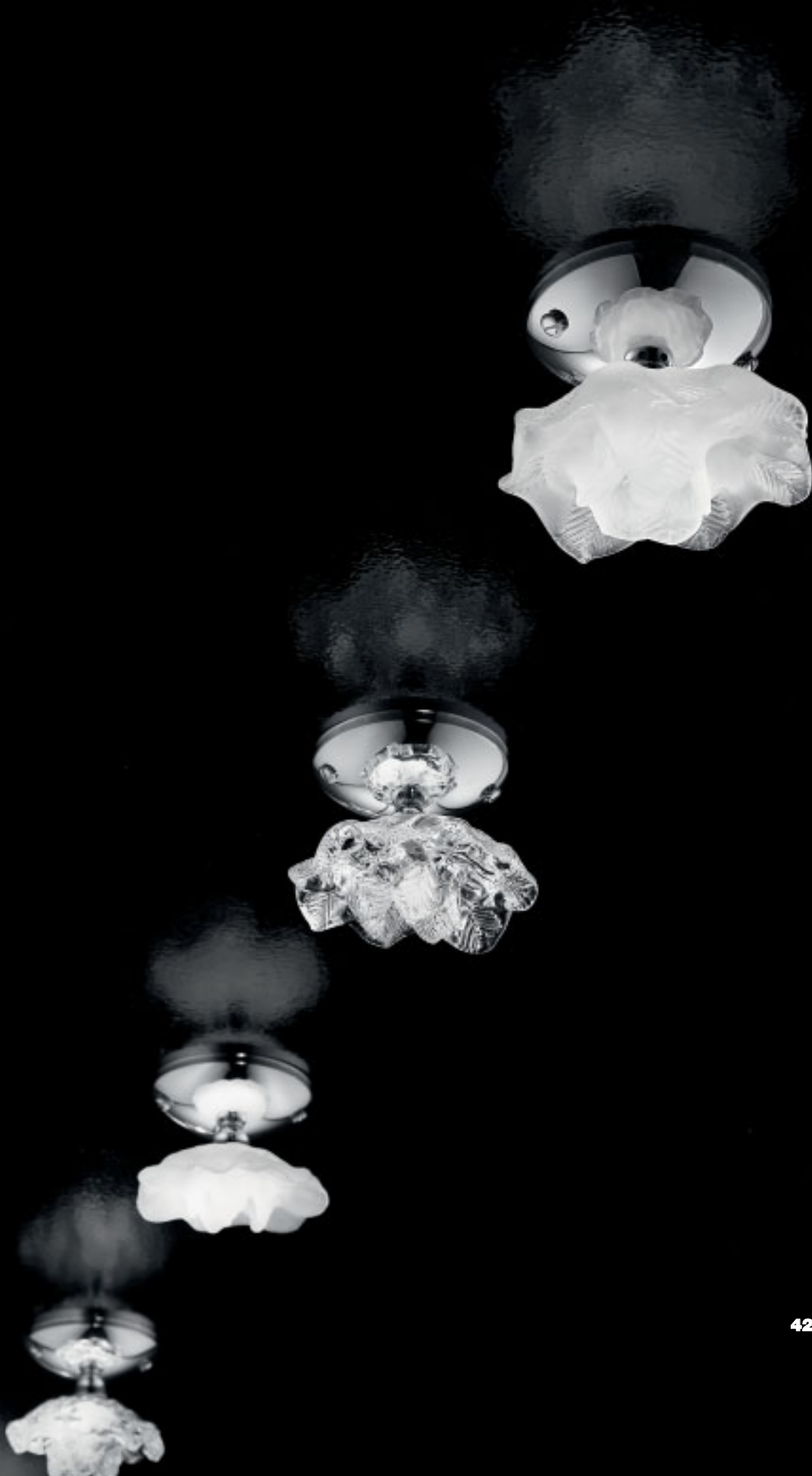

426/1PF plafoniera ceiling lamp



426/6P *piantana floor lamp*



bouquet

bouquet DESIGN *cristian feltrin*



trasparente
transparent

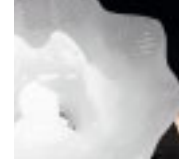

bianco satinato
satin white

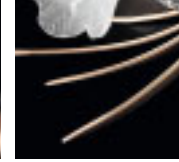

"bronzo camus"
"camus bronze"

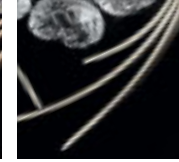

"platino alfiere"
"alfieri platinum"

Telaio principale in metallo cromato. Inserti in metallo tagliato al laser, disponibili nelle finiture "bronzo camus" e "platino alfiere".

I prodotti sono disponibili con ambedue le finiture oppure con finitura singola.

Rose grandi in vetro di Murano disponibili in vetro bianco satinato oppure trasparente.

Rose piccole in vetro di Murano tutte trasparenti.

Main Frame in chromed metal.

Inserts in metal laser-cut, available in finishes "camus bronze" and "alfieri platinum".

The products are available on either trim or finish single.

Large Murano glass roses available in white satin glass or transparent.

Small Murano glass roses all transparent.

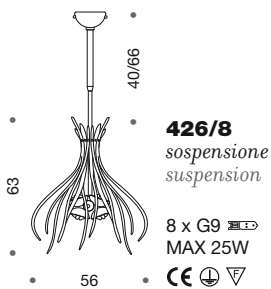

426/8
sospensione
suspension

8 x G9
MAX 25W

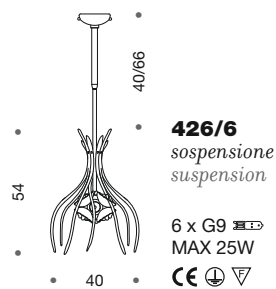

426/6
sospensione
suspension

6 x G9
MAX 25W

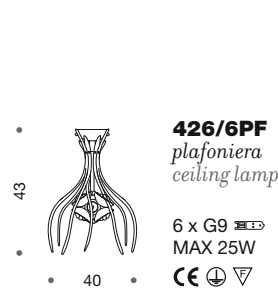

426/6PF
plafoniera
ceiling lamp

6 x G9
MAX 25W



426/1PF
plafoniera
ceiling lamp

1 x G9
MAX 25W

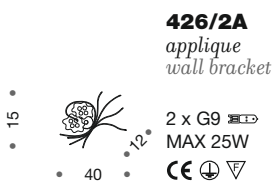

426/2A
applique
wall bracket

2 x G9
MAX 25W

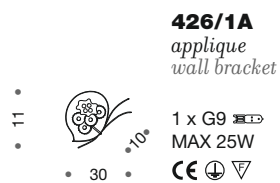

426/1A
applique
wall bracket

1 x G9
MAX 25W



426/2L
lampada tavolo
table lamp

2 x G9
MAX 25W

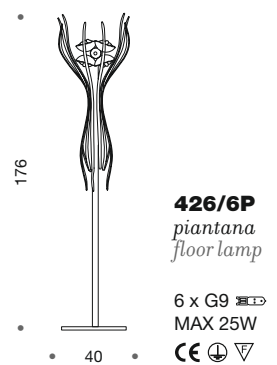

426/6P
piantana
floor lamp

6 x G9
MAX 25W



DESIGN *cristian feltrin*
girasole



La collezione "Girasole" è reinterpretata nel suo massimo splendore. La preziosa finitura in foglia oro, eccellentemente eseguita a mano sui metalli forgiati e i cristalli Swarovski nella sfumatura Golden Teak, sapientemente abbinati ai particolari in oro chiaro, regala sontuosità e un raffinato lusso a un corpo illuminante già padrone di prestigio.

Collection "Girasole" is reinterpreted in its full glory. The precious gold leaf finish, finely executed by hand on the metal forgings and Swarovski crystals in shades Golden Teak, cleverly combined with the special gold clear, gives a refined elegance and luxury to an already illuminating body master prestige.

gi
sa
se







374/4A *applique wall bracket*

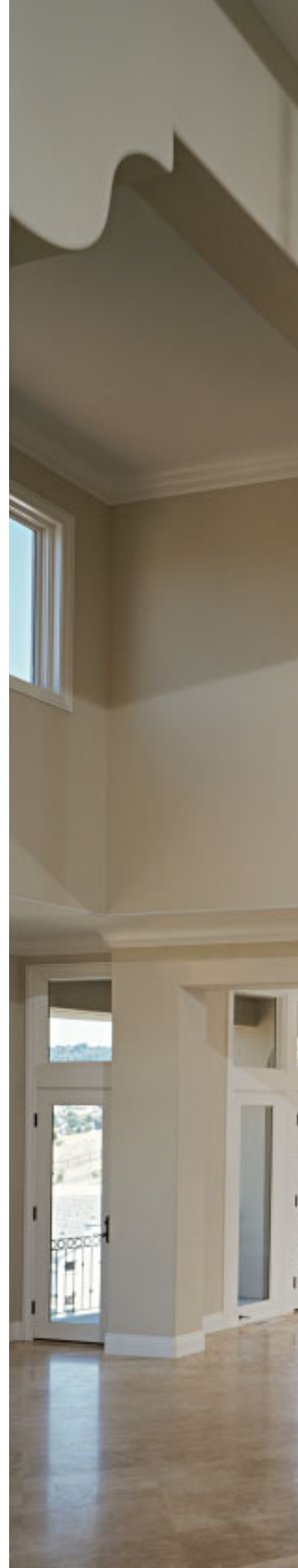



374/18+18 lampadario chandelier



374/12+6 *lampadario chandelier*

gi ra sole

girasole DESIGN *cristian feltrin*



vetro trasparente
transparent glass



trasparente
transparent



topazio
topaz



viola
violet



golden teak
golden teak

Telaio in metallo disponibile nelle seguenti combinazioni di finiture:

- foglia oro con parti in oro chiaro, cristalli Swarovski Strass golden teak
 - foglia oro con parti in oro verniciato, cristalli Swarovski Strass trasparenti
 - argento brillante con parti in cromo, cristalli Swarovski Strass trasparenti
 - nero lucido con parti in cromo, cristalli Swarovski Strass topazio
 - bianco lucido con parti in cromo, cristalli Swarovski Strass violet
- Eventuali variazioni di combinazione colore e cristalli sono possibili, secondo disponibilità.

Girasoli in vetro di Murano di colore trasparente.

Metal frame available in the following combinations of finishes:

- Gold leaf with gold shares in clear crystal Swarovski Strass golden teak
 - Gold leaf with gold painted parts, crystal Swarovski Strass transparent
 - Brilliant silver with parts in chrome, crystal Swarovski Strass transparent
 - Shiny black with parts in chrome, crystal Swarovski Strass topaz
 - White with parts in shiny chrome, Swarovski Strass Crystal violet
- Any changes in colour and crystal combinations are possible, subject to availability Sunflowers Murano glass in transparent colour.

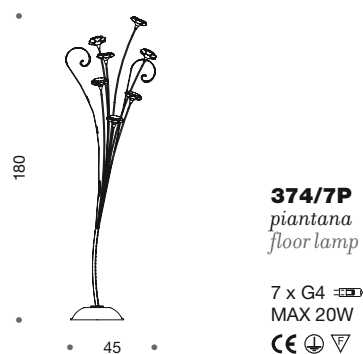
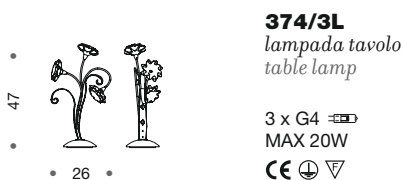
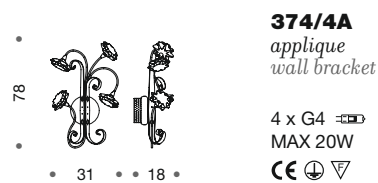
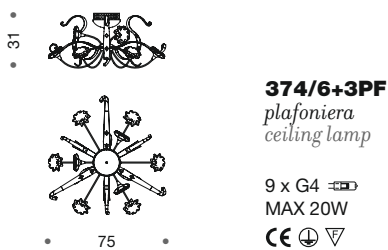
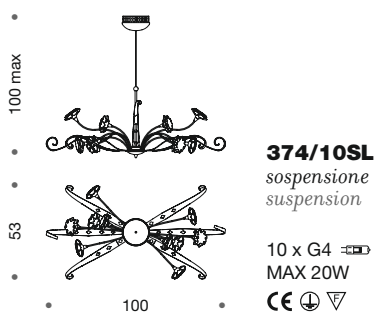
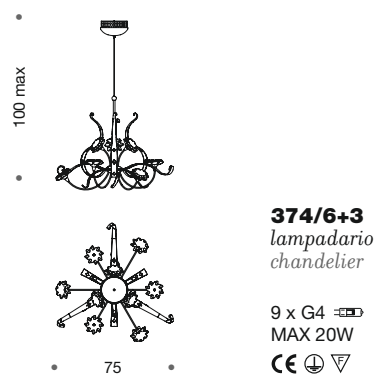
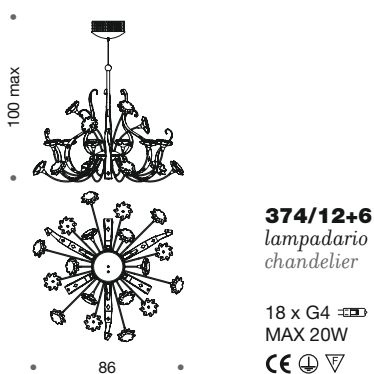
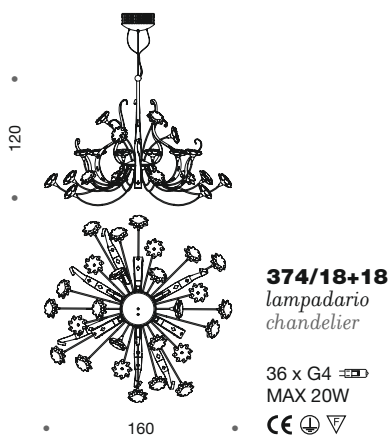

DESIGN *cristian feltrin***tuberose**

In un giardino segreto, un cilindro di vetro raccoglie intorno a sé un tripudio di rose in fiore.

E si illumina.

Nasce "Tuberose", una collezione autentica nel suo genere, infinitamente romantica.

In a secret garden, a glass cylinder gathers around him a blaze of precious roses in bloom.

...and it lights up.

"Tuberose", an authentic collection of its kind, infinitely romantic.





424/1SG *sospensione suspension*



424/1P *piantana floor lamp*



424/1L lampada tavolo table lamp

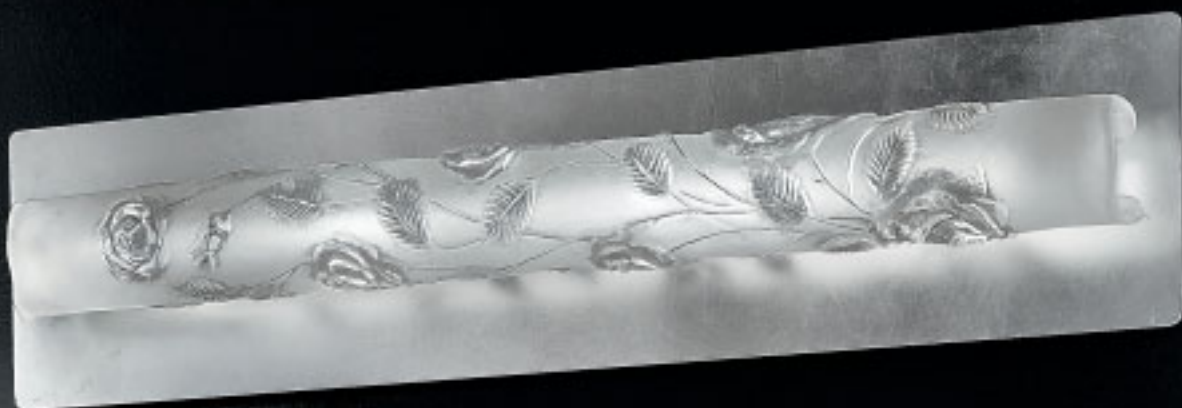

424/1AG plafoniera/applique ceiling lamp/wall bracket

424/1AM plafoniera/applique ceiling lamp/wall bracket

424/1AP plafoniera/applique ceiling lamp/wall bracket

tuberose

tuberose DESIGN *cristian feltrin*



bianco
white

argento
silver

oro
gold

viola
violet



madreperla
pearled white

foglia argento
silver leaf

foglia oro
gold leaf

viola
violet

Telaio in metallo disponibile nelle finiture foglia argento, foglia oro, laccato bianco madreperlato e laccato viola. Cilindro in vetro di Murano acidato con rose in rilievo, lavorato e decorato a mano, disponibili delle varianti colore argento, oro, bianco e viola. Nella piantana e sospensione, le parti in metallo sono in finitura cromo o placcato oro 24kt.

Metal frame finish available in silver leaf, gold leaf, pearled white lacquered and violet lacquered. Cylinder in Murano glass with roses in relief, hand worked and decorated, in available variants silver, gold, white and violet. In the suspension and floor lamp, the metal parts are finished in chrome or 24kt gold plated.

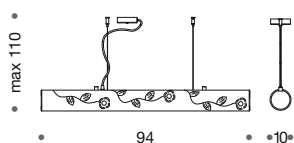

424/1SG
sospensione
suspension

1 x FQ/T5 ←
MAX 39W
CE ⊕ ▽

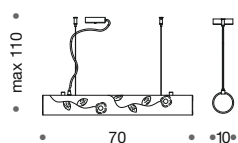

424/1S
sospensione
suspension

1 x FQ/T5 ←
MAX 24W
CE ⊕ ▽

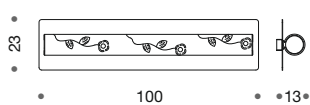

424/1AG
plafoniera/applique
ceiling lamp/wall
bracket

1 x FQ/T5 ←
MAX 39W
CE ⊕ ▽

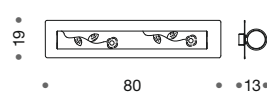

424/1AM
plafoniera/applique
ceiling lamp/wall
bracket

1 x FQ/T5 ←
MAX 24W
CE ⊕ ▽

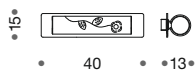

424/1AP
plafoniera/applique
ceiling lamp/wall
bracket

1 x G24q-2 ←
MAX 18W
CE ⊕ ▽

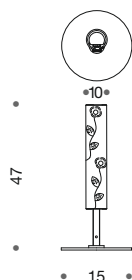

424/1L
lampada tavolo
table lamp

1 x G24q-2 ←
MAX 18W
CE ⊕ ▽

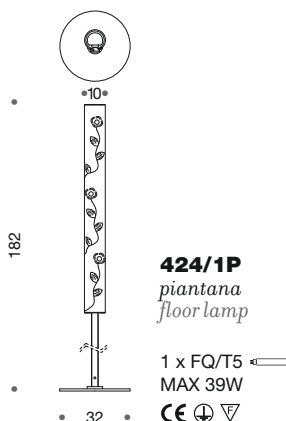

424/1P
piantana
floor lamp

1 x FQ/T5 ←
MAX 39W
CE ⊕ ▽

DESIGN *cristian feltrin***glossy**

Tecnica e lavorazione eccellente del metallo unitamente al vetro sono le caratteristiche principali di "Glossy" che trae il suo nome dall'effetto brillante dei materiali usati e dalla sua unicità nel design, dalle maestrie nel combinare la leggerezza del vetro alla forza del metallo.

Excellent technical and processing of metal and glass are the main features of "Glossy" which takes its name from the brilliant of the materials used and its unique design, from teachers to combine the lightness of glass to the strength of the metal.





432/2S *sospensione suspension*



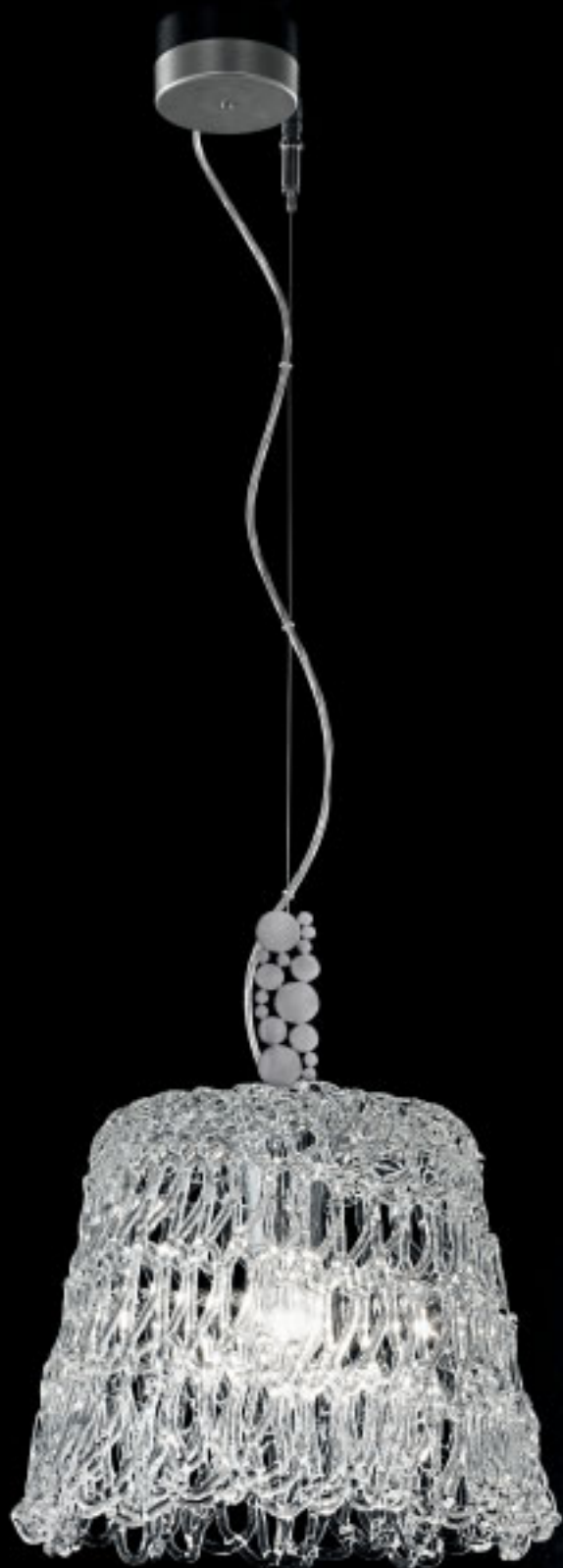

432/1SP *sospensione suspension*



432/1SG *sospensione suspension*

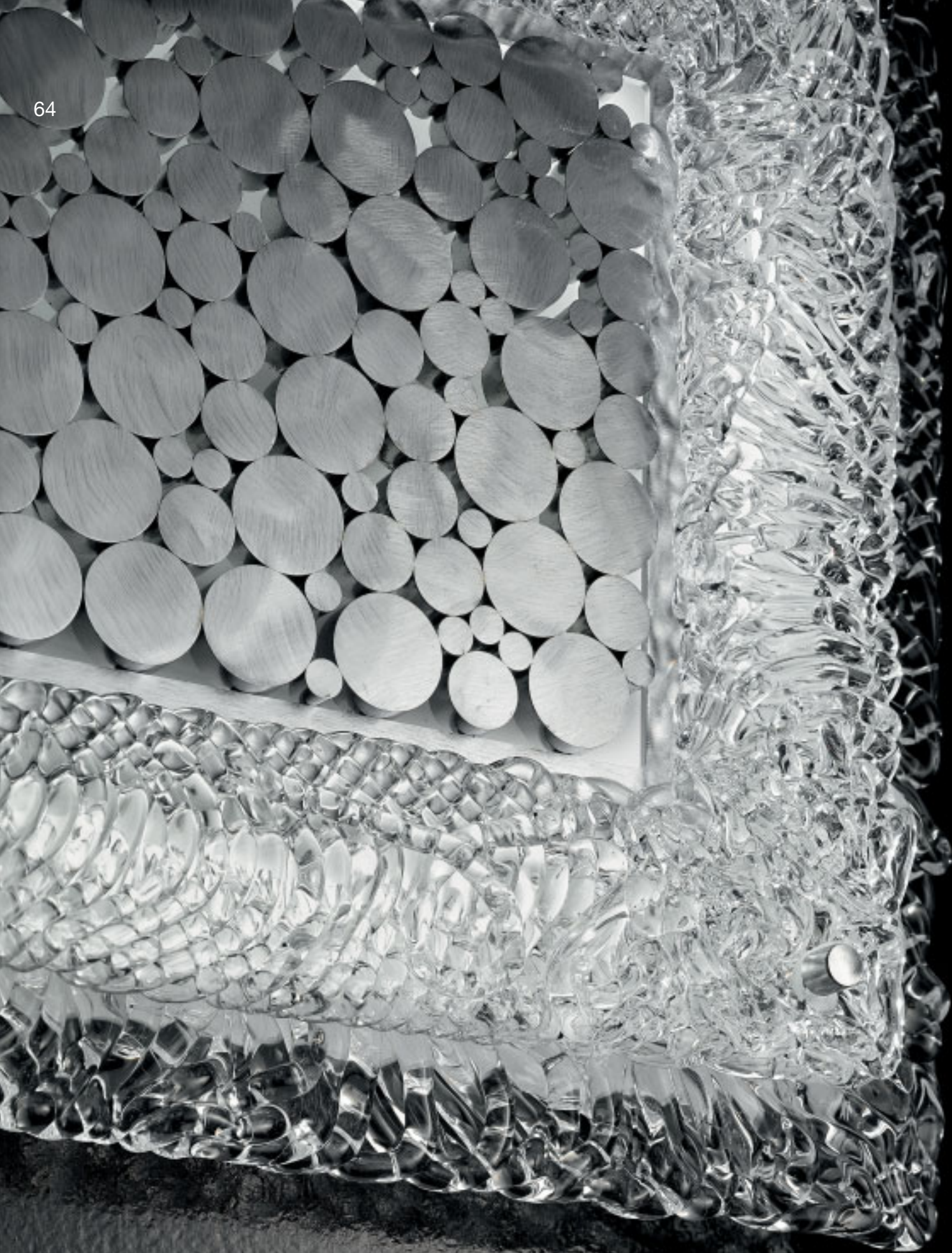

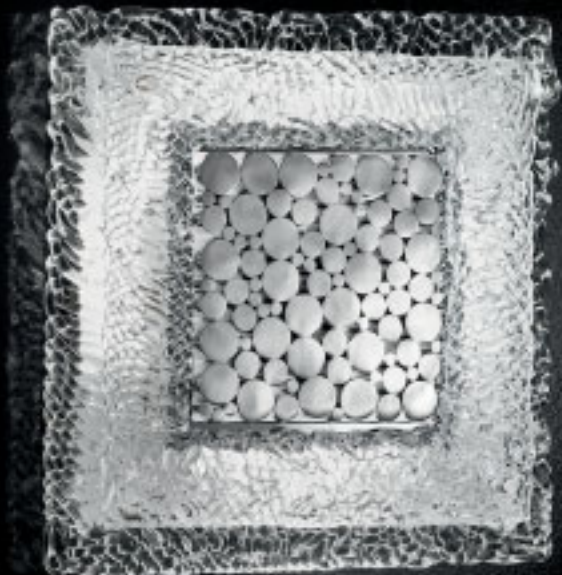
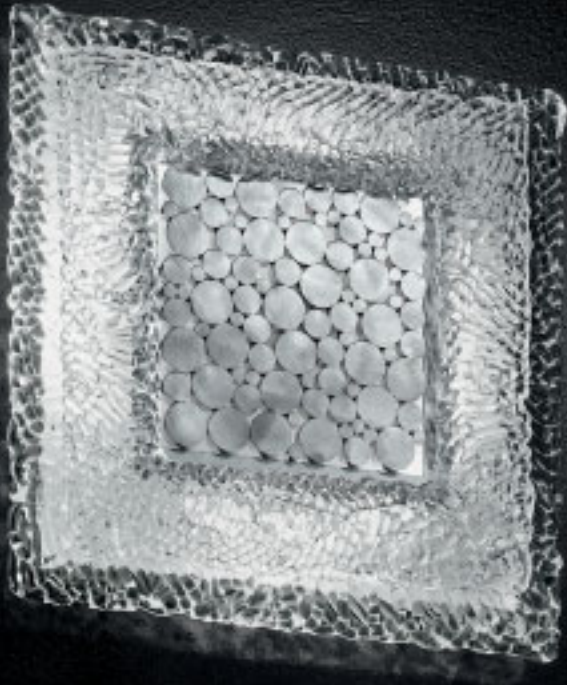

432/40 *applique wall bracket*

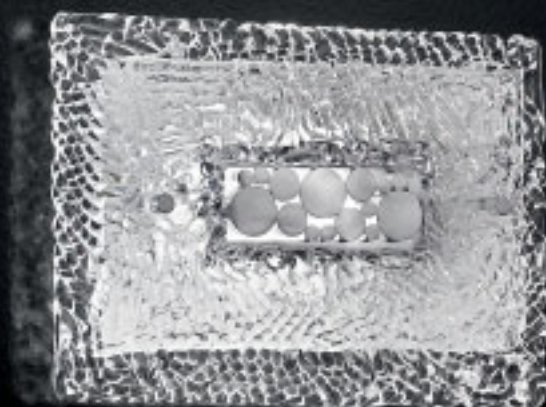
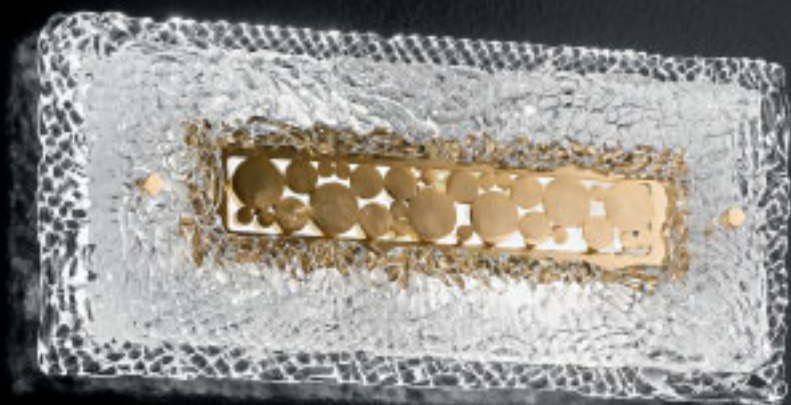
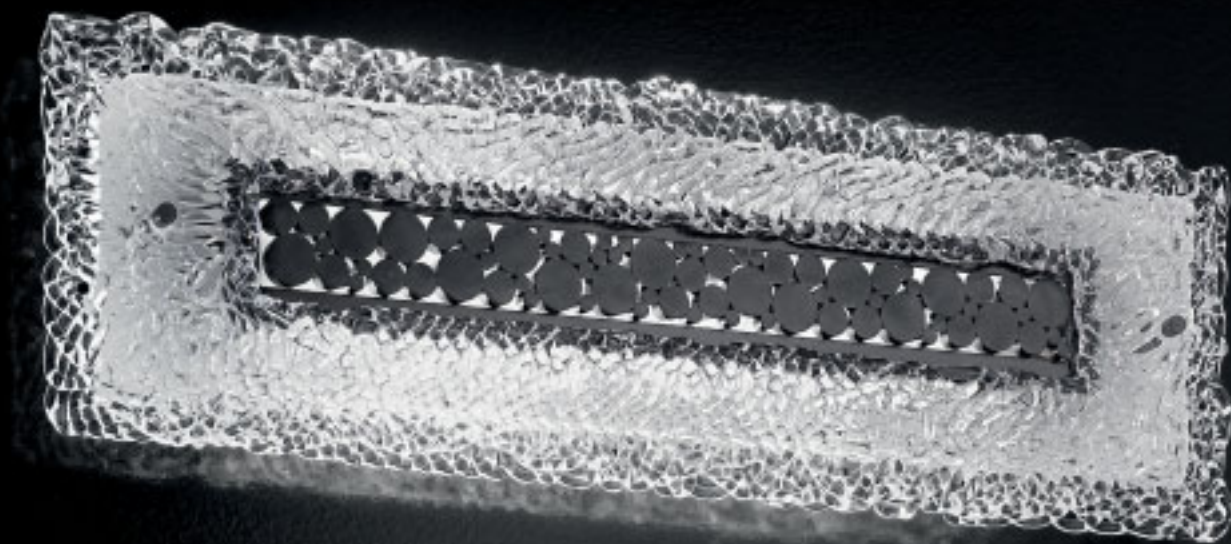

432/77 *applique wall bracket*

432/45 *applique wall bracket*

432/32 *applique wall bracket*

glossy

glossy DESIGN *cristian feltrin*

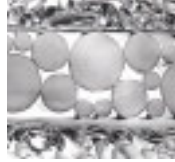

chromo spazzolato
brushed chrome



oro spazzolato
brushed gold

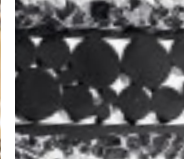

nickel nero
spazzolato
brushed black
nickel

Telaio in metallo disponibile nelle finiture chromo spazzolato, oro spazzolato o nickel nero spazzolato.

Cornice in vetro trasparente lavorata a mano a filo.

Nella sospensione, cavi di sostegno in acciaio inox.

Metal frame available in brushed chrome finish, brushed gold or brushed nickel black.

Frame in transparent glass hand worked wire.

In the suspension, cables for support are in stainless steel.

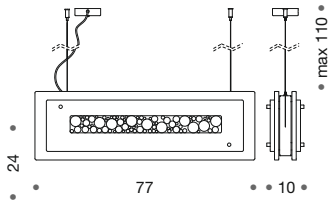

432/2S
sospensione
suspension

2 x FQ/T5
MAX 24W
CE ⊕ ▽

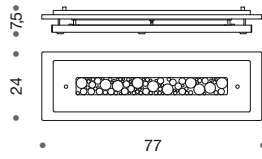

432/77
plafoniera/applique
ceiling lamp/wall
bracket

2 x FQ/T5
MAX 24W
CE ⊕ ▽

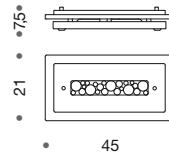

432/45
plafoniera/applique
ceiling lamp/wall
bracket

2 x G24q-2
MAX 18W
CE ⊕ ▽

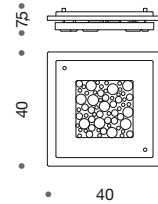

432/40
plafoniera/applique
ceiling lamp/wall
bracket

1 x FC/T5
MAX 40W
CE ⊕ ▽

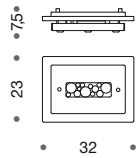

432/32
plafoniera/applique
ceiling lamp/wall
bracket

1 x G24q-2
MAX 18W
CE ⊕ ▽



432/1SG
sospensione
suspension

1 x E27
MAX 100W
or 1 x E27
MAX 24W
CE ⊕ ▽

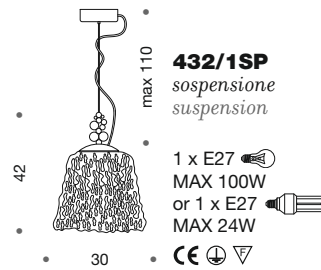

432/1SP
sospensione
suspension

1 x E27
MAX 100W
or 1 x E27
MAX 24W
CE ⊕ ▽

DESIGN *cristian feltrin***ice cube**

E' proprio pensando ad un insieme di cubetti di ghiaccio che nasce la collezione "Ice Cube", dove una sequenza di Vetri di Murano prendono forma e si illuminano di luce propria per riscaldare l'ambiente che la circonda. Mai del ghiaccio ha trasmesso tanto calore.

The collection "Ice Cube" thinking comes to a set of cubes of ice, where a sequence of Murano glass take shape and glow of light to heat its environment. Ice has never sent so much heat.

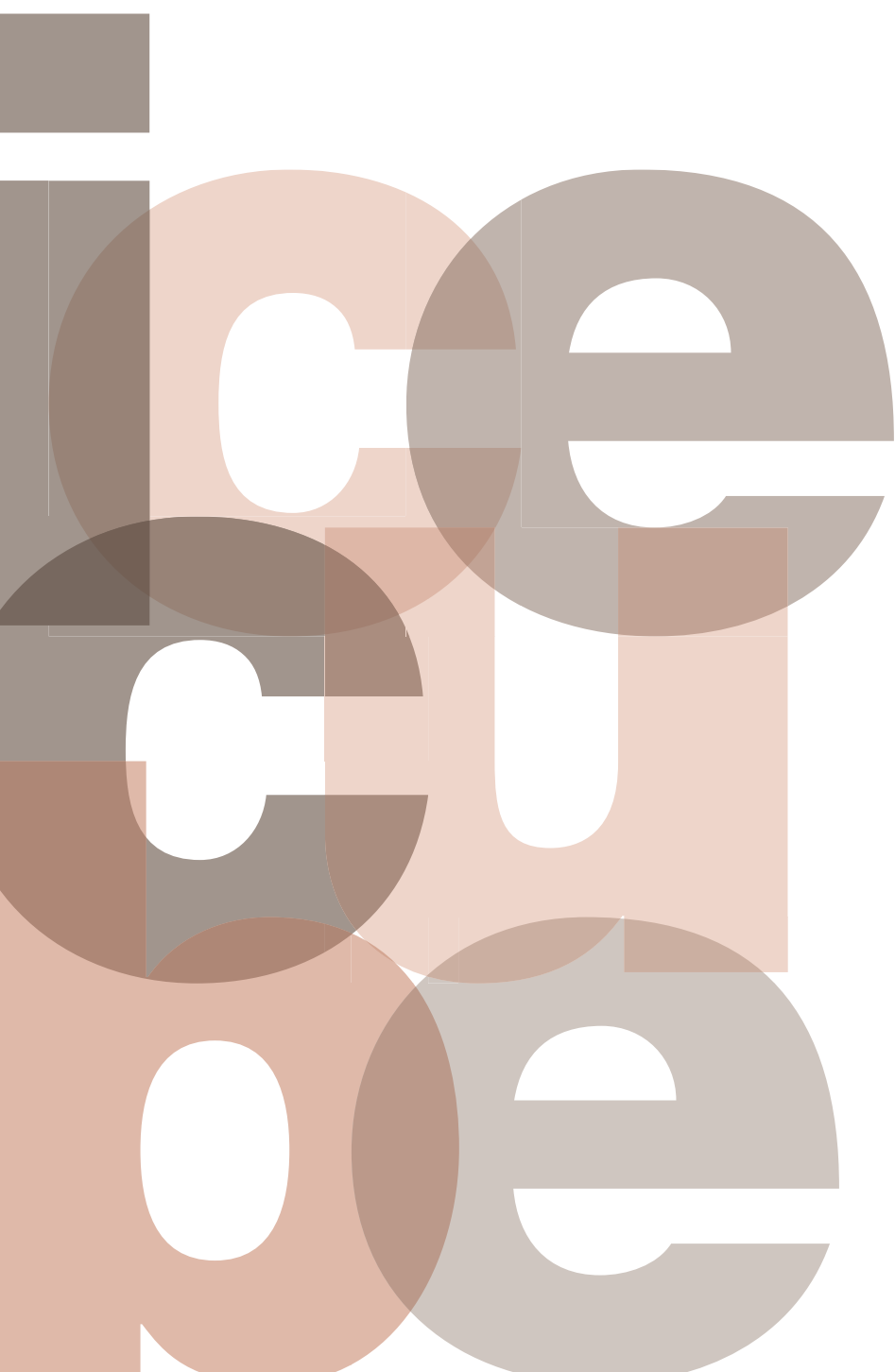



428/98X18 plafoniera/applique ceiling lamp/wall bracket

428/75X13 plafoniera/applique ceiling lamp/wall bracket

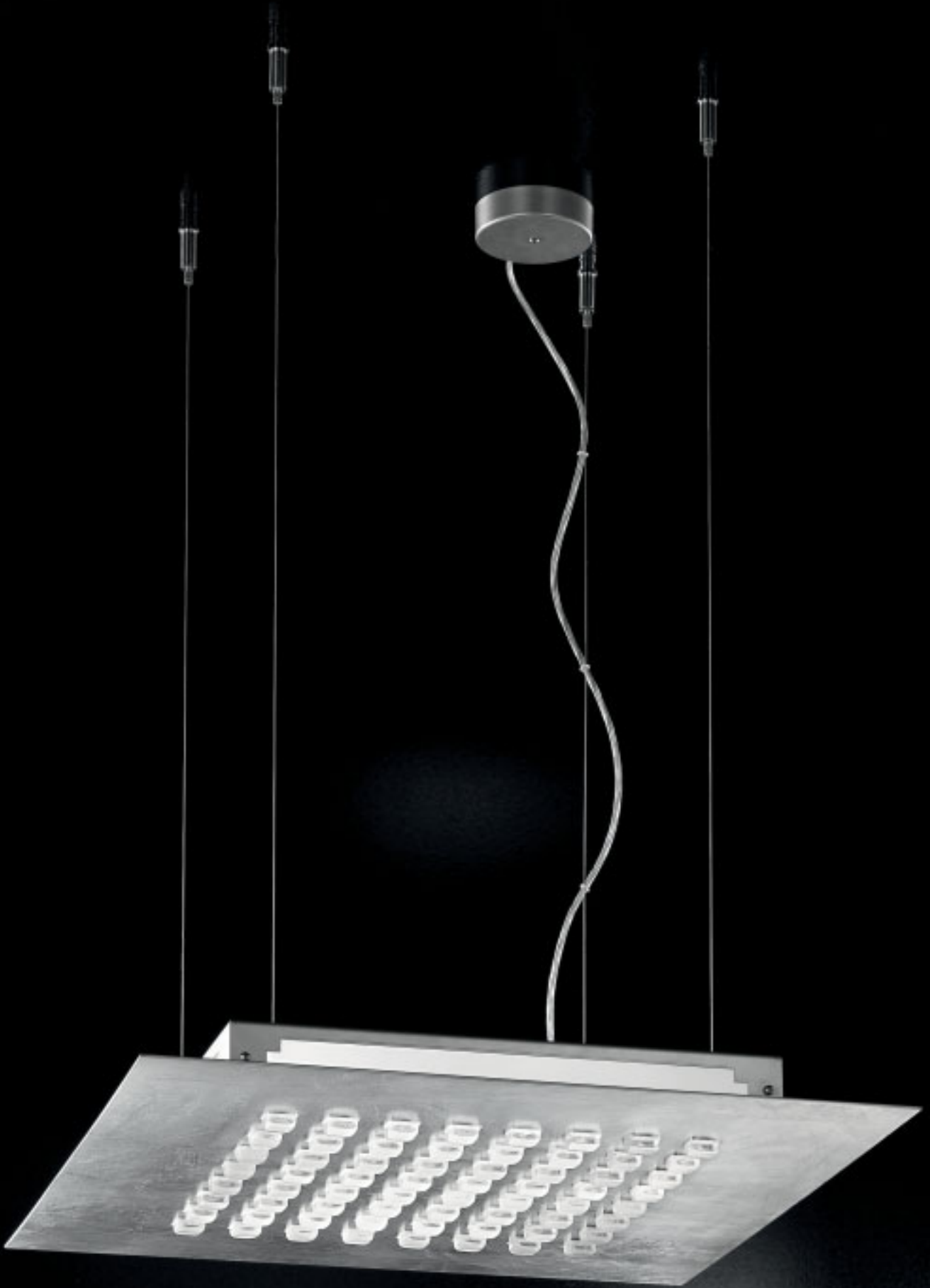

428/1S *sospensione* *suspension*

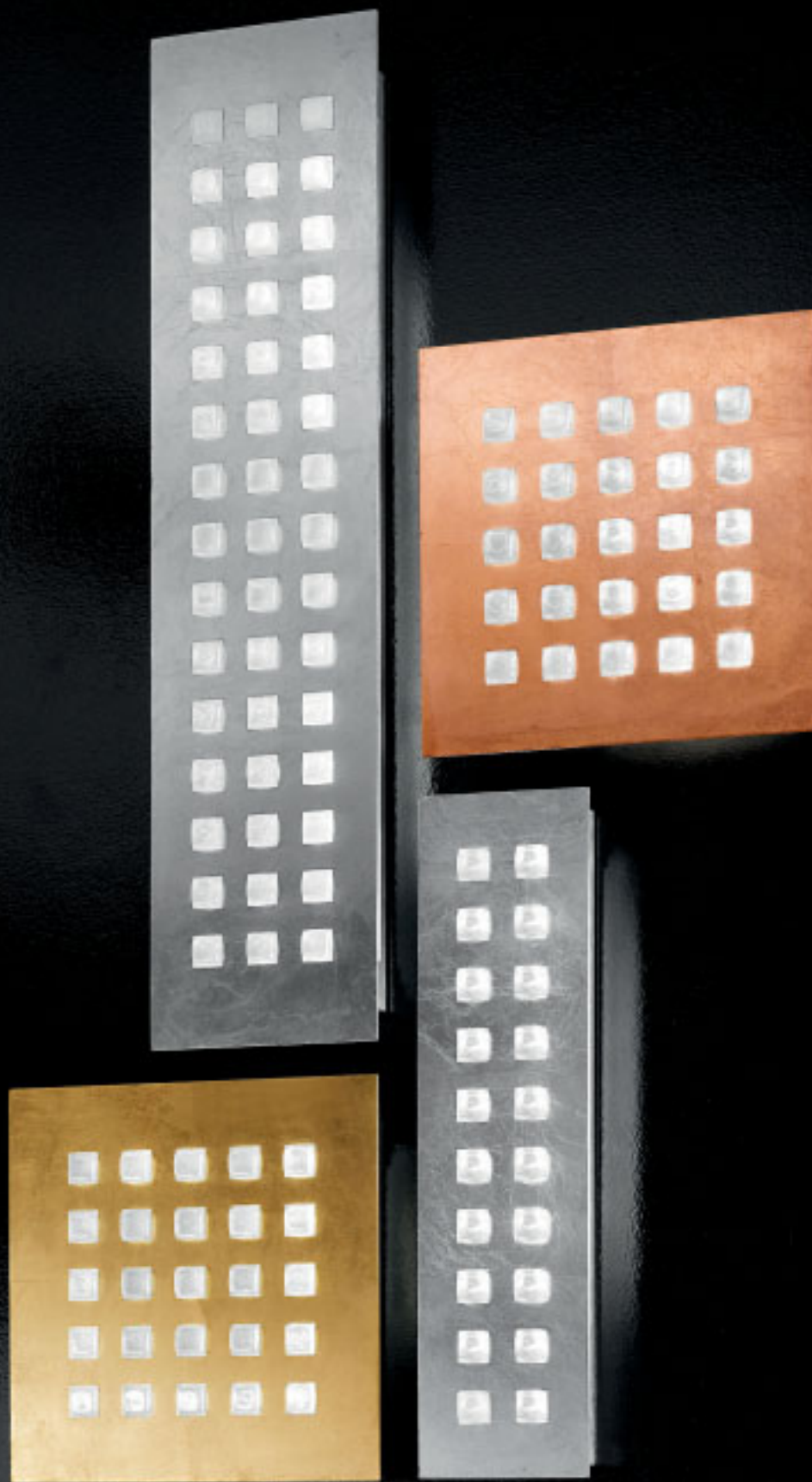

428/76X18 plafoniera/applique ceiling lamp/wall bracket

428/30x30 plafoniera/applique ceiling lamp/wall bracket

428/30x30 plafoniera/applique ceiling lamp/wall bracket

428/53X13 plafoniera/applique ceiling lamp/wall bracket

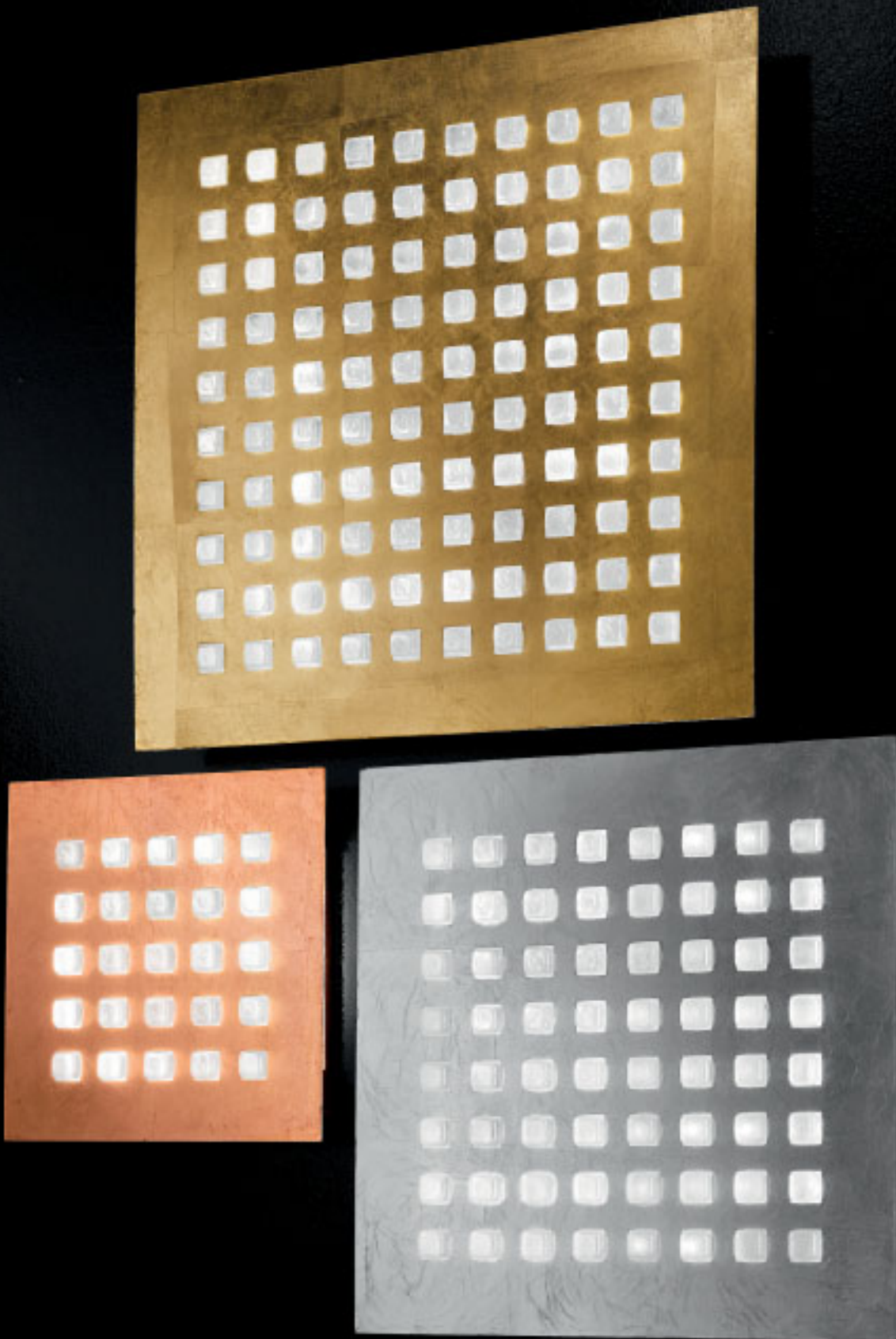

428/30X30 plafoniera/applique ceiling lamp/wall bracket

428/45X45 plafoniera/applique ceiling lamp/wall bracket

428/54X54 plafoniera/applique ceiling lamp/wall bracket

ice cube

ice cube DESIGN cristian feltrin



foglia argento
silver leaf

foglia oro
gold leaf

foglia rame
copper leaf

Telaio in metallo disponibile nelle finiture foglia argento, foglia oro e foglia rame.
Vetro diffusore con lavorazione a cubetti in rilievo, con finitura bianco lucido.
Nella sospensione, cavi di sostegno in acciaio inox.
Metal frame finish available in silver leaf, gold leaf and copper leaf.
Glass diffuser with processing cubes in relief, in white glossy finish.
In the suspension, cables for support are in stainless steel.

428/1S
sospensione
suspension

• max 110 •

• 3 x 2G11 •
MAX 24W + dimmer

CE ⊕ ▽

428/98X18
plafoniera/applique
ceiling lamp/
wall bracket

• 2 x FQ/T5 •
MAX 39W

CE ⊕ ▽

428/76X18
plafoniera/applique
ceiling lamp/
wall bracket

• 2 x FQ/T5 •
MAX 24W

CE ⊕ ▽

428/75X13
plafoniera/applique
ceiling lamp/
wall bracket

• 2 x FQ/T5 •
MAX 24W

CE ⊕ ▽

428/53X13
plafoniera/applique
ceiling lamp/
wall bracket

• 1 x 2G11 •
MAX 24W

CE ⊕ ▽

428/54X54
plafoniera/applique
ceiling lamp/
wall bracket

• 4 x 2G11 •
MAX 24W + dimmer

CE ⊕ ▽

428/45X45
plafoniera/applique
ceiling lamp/
wall bracket

• 3 x 2G11 •
MAX 24W

CE ⊕ ▽

428/30X30
plafoniera/applique
ceiling lamp/
wall bracket

• 1 x FC/T5 •
MAX 22W

CE ⊕ ▽



DESIGN *cristian feltrin***mary**

La collezione "Mary" dona prestigio e regalità a ogni ambiente. Circondata da paralumi in organza e cristalli, è emblema di una ricerca glamour e dedicata ad ambienti di autentica raffinatezza, degni del suo massimo splendore.

The collection "Mary" gives prestige and royalty to any room. Surrounded by lampshades in organza and crystal, is emblematic of a glamorous and research environments devoted to refinement of authentic, worthy of its full glory.

mary









387/18 *sospensione suspension*



387/8 *sospensione suspension*

mary

mary DESIGN cristian feltrin



paralume ghiaccio
lampshade ice
colour



paralume nero
lampshade black
colour



paralume marrone
ramato
lampshade coppery
brown



cubetto cristallo
ametista
amethyst crystal
cube



cubetto cristallo
trasparente
transparent crystal
cube

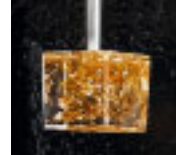

cubetto cristallo
ambra
amber crystal
cube

Telaio in metallo cromato.

Pendenti in cristallo molato trasparente.

Paralumi in organza, disponibili nei colori nero, ghiaccio e marrone ramato.

Cubetti in cristallo molato disponibili nei colori trasparente, ametista e ambra.

Chromed metal frame.

Pendants in clear cut crystal.

Lampshades in organza, available in black, ice and coppery brown.

Cubes in cut crystal available in colours transparent, amethyst and amber.

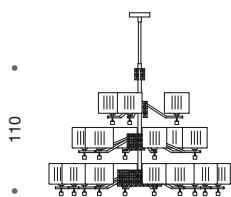

• 110

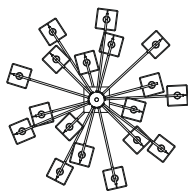

• 110 •

387/18
sospensione
suspension

18 x E14
MAX 40W or
18 x E14
MAX 9W

CE ⊕ ▽

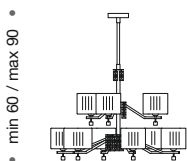

• min 60 / max 90



• 80,5 •

387/6+3
sospensione
suspension

9 x E14
MAX 60W or
9 x E14
MAX 9W

CE ⊕ ▽

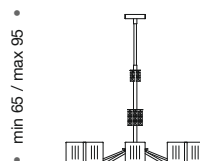

• min 65 / max 95

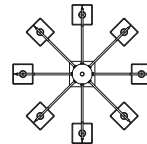

• 83,5 •

387/8
sospensione
suspension

8 x E14
MAX 60W or
8 x E14
MAX 9W

CE ⊕ ▽

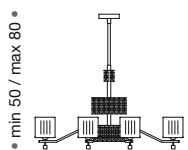

• min 50 / max 80

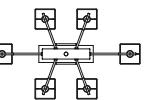

• 87 •

387/6R
sospensione
suspension

6 x E14
MAX 60W or
6 x E14
MAX 9W

CE ⊕ ▽

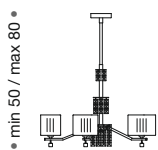

• min 50 / max 80

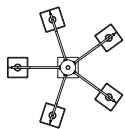

• 72,5 •

387/5
sospensione
suspension

5 x E14
MAX 60W or
5 x E14
MAX 9W

CE ⊕ ▽

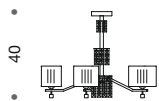

• 40

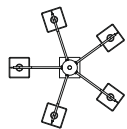

• 72,5 •

387/5PF
plafoniera
ceiling lamp

5 x E14
MAX 60W or
5 x E14
MAX 9W

CE ⊕ ▽

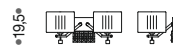

• 19,5 •

• 45 • 23,5 •

387/2A
applique
wall bracket

2 x E14
MAX 60W or
2 x E14
MAX 9W

CE ⊕ ▽

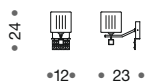

• 24 •

• 12 • 23 •

387/1A
applique
wall bracket

1 x E14
MAX 60W or
1 x E14
MAX 9W

CE ⊕ ▽

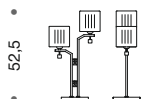

• 52,5

• 29,5 • 16 •

387/2L
lampada tav.
table lamp

2 x E14
MAX 60W or
2 x E14
MAX 9W

CE ⊕ ▽

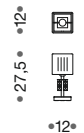

• 12 •

• 27,5 •

387/1L
lampada tav.
table lamp

1 x E14
MAX 60W or
1 x E14
MAX 9W

CE ⊕ ▽

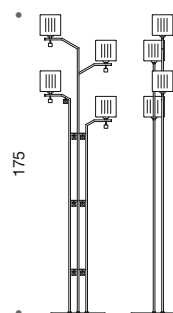

• 175

• 45 • 32 •

387/4P
piantana
floor lamp

4 x E14
MAX 60W or
4 x E14
MAX 9W

CE ⊕ ▽

DESIGN *cristian feltrin*
artesia



Da un perfetto incontro tra arte e fantasia creativa nasce la collezione "Artesia", un evolversi di forme armoniche fantasiosamente intrecciate quasi a creare un astratto dipinto, impreziosito dai cristalli Swarovski incastonati come pietre su un pezzo d'arte.

Flutes in vetro di Murano a effondere luce in uno skyline degno dei più sofisticati loft.

From a perfect meeting of art and creative imagination comes the collection "Artesia", a harmonious development of imaginative forms woven to create a nearly abstract painting, embellished by Swarovski crystals set like stones on a piece of art. Murano glass flutes to effuse light in a skyline worthy of the most sophisticated loft.

Artesia

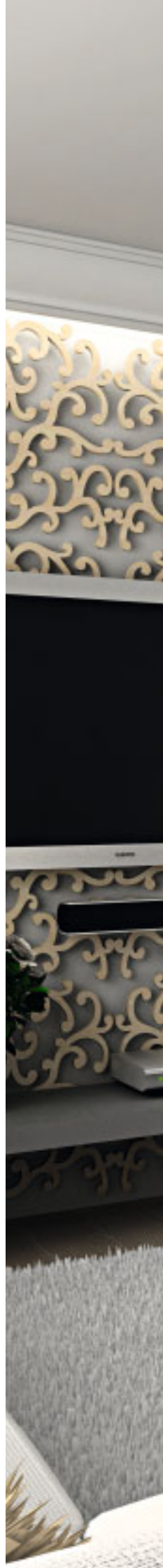



420/8 sospensione suspension



420/4P *piantana floor lamp*

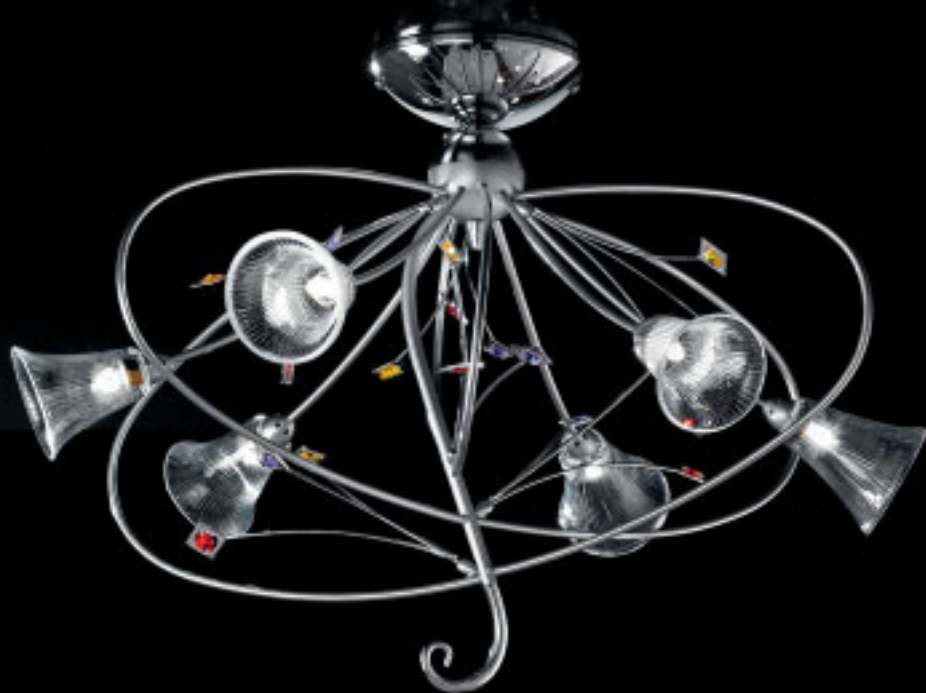

420/6PF *plafoniera ceiling lamp*

420/6 *sospensione suspension*



420/1L lampada tavolo table lamp

420/1A applique wall bracket

420/2L lampada tavolo table lamp

artesia

DESIGN *cristian feltrin*



bianco lucido
glossy white



trasparente
transparent



crystallo ambra
amber crystal

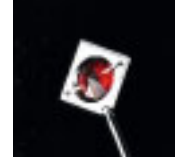

crystallo rosso
red crystal

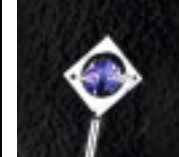

crystallo blu
blue crystal

Telaio in metallo disponibile nelle finiture argento brillante e cromo o grigio antracite e cromo.

Vetri diffusori disponibili nella variante colore bianco lucido o trasparente.

Inserti in cristallo Swarovski Strass® disponibili nei colori ambra, viola e rosso.

La combinazione dei cristalli può essere multicolore oppure di colore unico.

Metal frame available in bright silver finish and chrome or anthracite gray and chrome.

Glass diffusers available in glossy white variant or transparent.

Inserts Swarovski Strass® crystal available in the colours of amber, violet and red.

The combination of crystals can be multicoloured or unique colour.

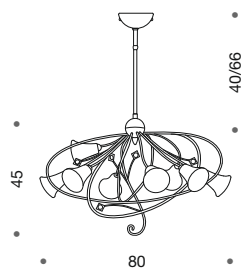

420/8
sospensione
suspension

8 x G9 MAX 25W
CE

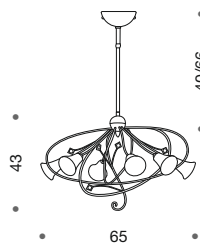

420/6
sospensione
suspension

6 x G9 MAX 25W
CE

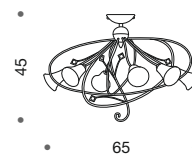

420/6PF
plafoniera
ceiling lamp

6 x G9 MAX 25W
CE

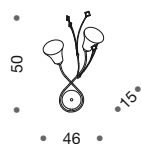

420/2A
applique
wall bracket

2 x G9 MAX 25W
CE

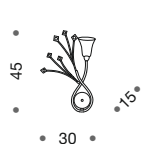

420/1A
applique
wall bracket

1 x G9 MAX 25W
CE

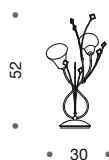

420/2L
lampada tavolo
table lamp

2 x G9 MAX 25W
CE



420/1L
lampada tavolo
table lamp

1 x G9 MAX 25W
CE

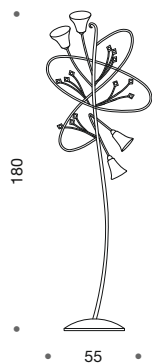

420/4P
piantana
floor lamp

4 x G9 MAX 25W
CE

DESIGN *IDL design staff***tulipe**

Punte in cristallo e boccioli di tulipano in vetro di Murano compongono la collezione "Tulipe", donando vita a oggetti che, ispirati alla natura, si impadroniscono dei nuovi contesti del living moderno, abbinando colori, forme e morbidi bagliori di luce a

spazi essenziali e di puro design.

Crystal tips and tulip buds made of Murano glass make up the collection "Tulipe", giving life to objects, inspired by nature, take possession of the new contexts of modern living, combining colours, shapes and soft gleam of light in essential spaces of pure design.





419/8 *sospensione suspension*



419/6 *sospensione suspension*

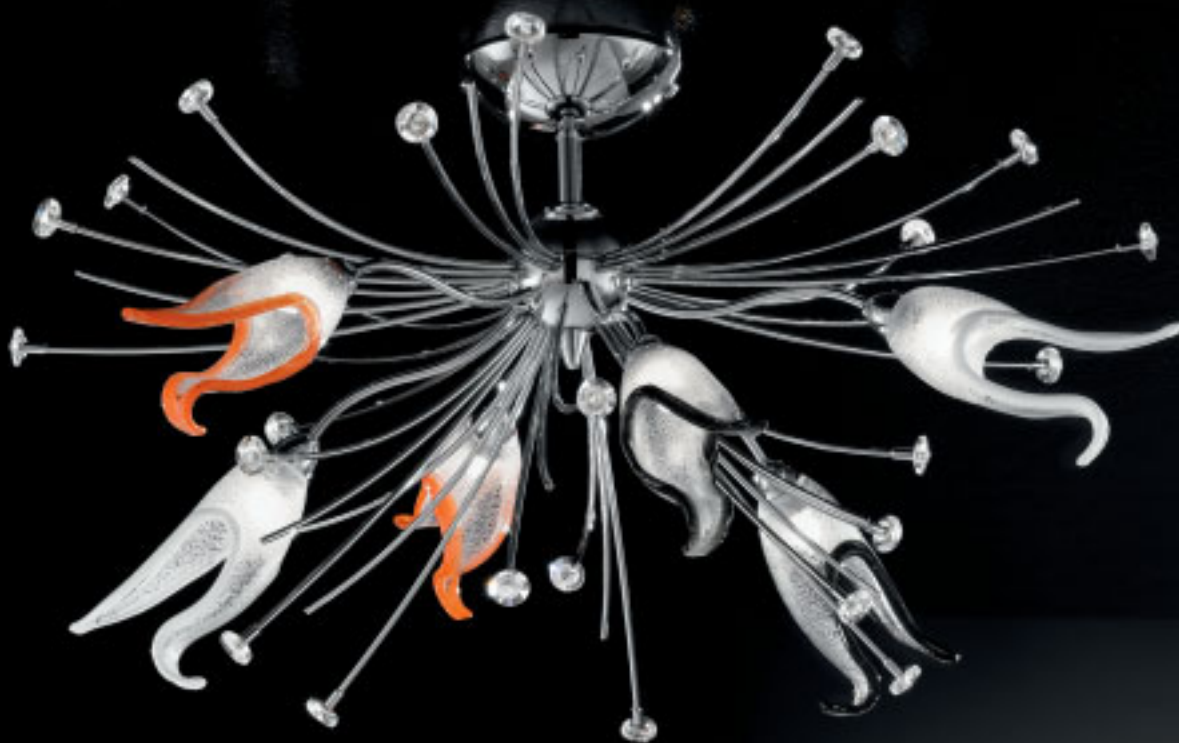

419/6PF plafoniera ceiling lamp

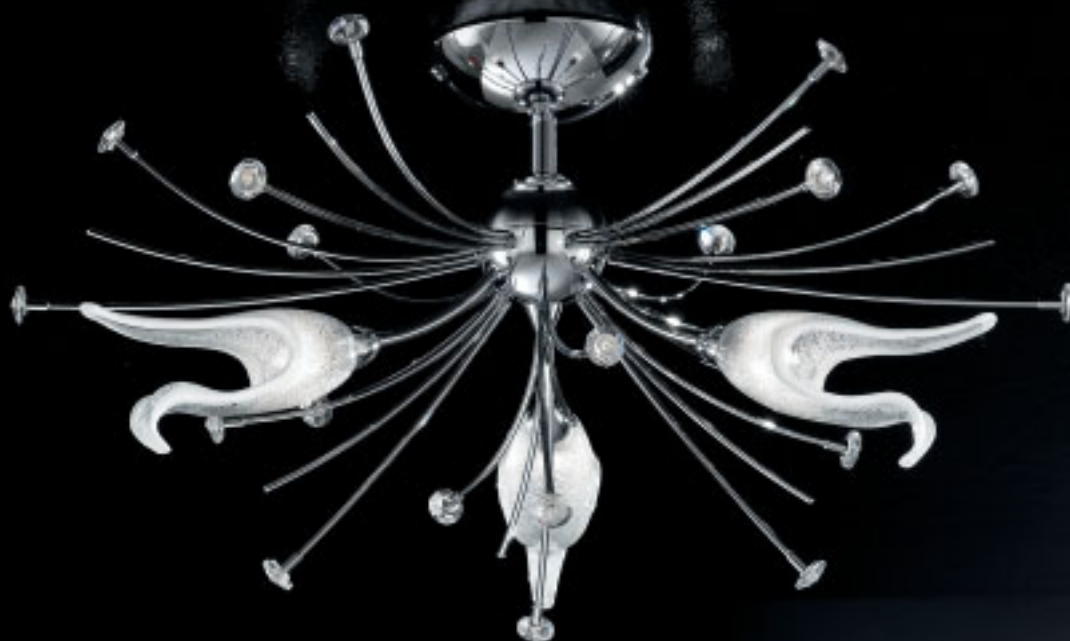

419/3PF plafoniera ceiling lamp



419/4P *piantana floor lamp*



419/2A *applique wall bracket*
419/1L *lampada tavolo table lamp*



419/1A *applique wall bracket*
419/2L *lampada tavolo table lamp*



tulipe

tulipe DESIGN IDL design staff

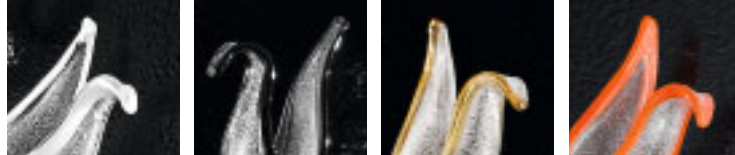

bordo bianco
bianco edge

bordo nero
black edge

bordo ambra
amber edge

bordo arancio
orange edge

Telaio in metallo cromato.

Tulipani in Vetro di Murano sfumato bianco, disponibili con bordo arancio, nero, ambra o bianco.

Gli articoli sono disponibili con vetri multicolore e a colore unico, a richiesta.

Dettagli in cristallo molato.

Chromed metal frame.

Tulips in Murano glass, available in faded white finish with edge orange, black, amber or white.

The articles are available with multicoloured glass or with unique colour, on request. Details in cut crystal.

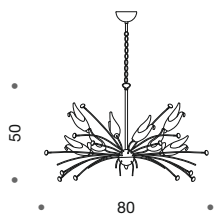

419/8
sospensione
suspension

8 x G9 MAX 25W
CE

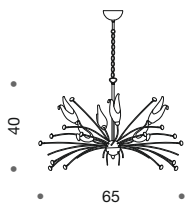

419/6
sospensione
suspension

6 x G9 MAX 25W
CE

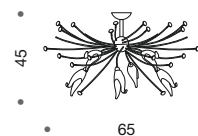

419/6PF
plafoniera
ceiling lamp

6 x G9 MAX 25W
CE

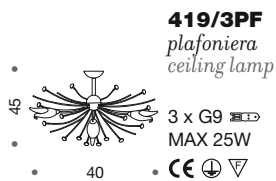

419/3PF
plafoniera
ceiling lamp

3 x G9 MAX 25W
CE

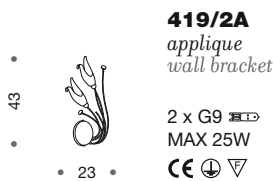

419/2A
applique
wall bracket

2 x G9 MAX 25W
CE

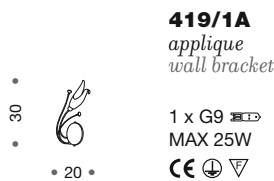

419/1A
applique
wall bracket

1 x G9 MAX 25W
CE

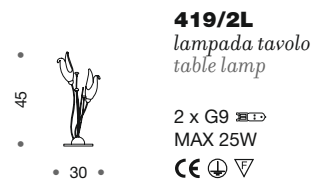

419/2L
lampada tavolo
table lamp

2 x G9 MAX 25W
CE

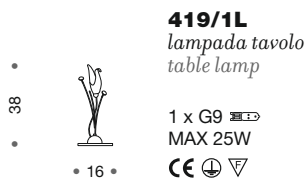

419/1L
lampada tavolo
table lamp

1 x G9 MAX 25W
CE

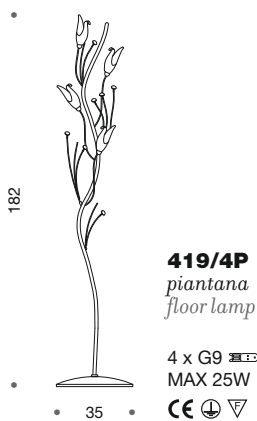

419/4P
piantana
floor lamp

4 x G9 MAX 25W
CE

DESIGN *IDL design staff***fleurs**

E' un'esplosione di fiori di cristallo la collezione "Fleurs", dove eleganti trasparenze incontrano le forme minimaliste ed essenziali delle strutture metalliche cromate. Il tutto contornato da effetti cromatici e chiaroscurali degni di una perfetta rappresentazione della leggerezza e leggiadria della natura.

It's an explosion of crystal flowers the collection "Fleurs", where elegant transparencies meet the essential and minimalist forms of metallic chrome. Surrounded by all the colour effects and nuances worthy of a perfect representation of the lightness and gracefulness of nature.

fleurs







351/10 *sospensione suspension*

351/10PF *plafoniera ceiling lamp*



351/20 *sospensione suspension*



351/5A applique wall bracket



351/5L lampada tavolo table lamp



351/9P piantana floor lamp

fleurs

fleurs DESIGN IDL design staff



trasparente
transparent

Telaio in metallo cromato.

Fiori in vetro di Murano di colore trasparente.

Chromed metal frame.

Murano glass flowers in transparent colour.

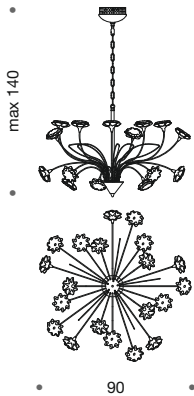

351/20
sospensione
suspension

20 x G4 MAX 10W

CE

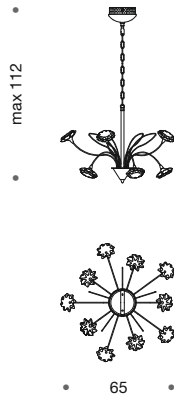

351/10
sospensione
suspension

10 x G4 MAX 20W

CE

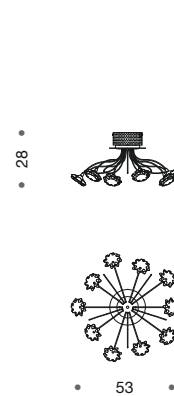

351/10PF
plafoniera
ceiling lamp

10 x G4 MAX 20W

CE

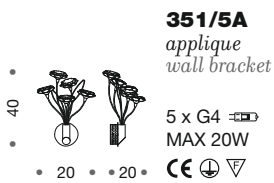

351/5A
applique
wall bracket

5 x G4 MAX 20W

CE

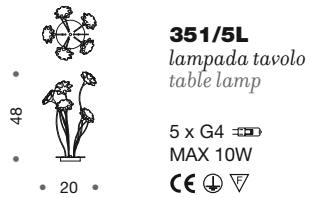

351/5L
lampada tavolo
table lamp

5 x G4 MAX 10W

CE

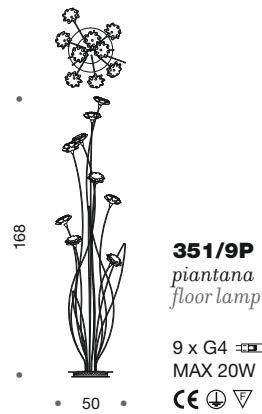

351/9P
piantana
floor lamp

9 x G4 MAX 20W

CE

DESIGN *IDL design staff***flute**

In una festa di mille colori prende vita la collezione "Flute", dove eleganti gusci colorati di vetro, si uniscono per decorare con giochi luminosi, donando sobrietà ma al tempo stesso importanza ai nuovi ambiziosi scenari abitativi.

In a feast of many colours comes to life collection "Flute", where elegant shells coloured glass, join games to decorate with lights, giving sobriety but at the same time emphasis on new housing ambitious sceneries.



flute





350/6+3 *sospensione suspension*



350/2A applique wall bracket

350/5 sospensione suspension

350/1L lampada tavolo table lamp





350/6P *piantana floor lamp*





bianco satinato
satin white

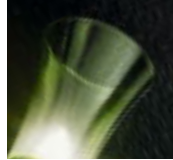

verde
green



viola
violet



rosso
red



giallo
yellow

flute

flute DESIGN IDL design staff

Telaio in metallo cromato o placcato oro 24kt.

Vetri diffusori verniciati con processo a caldo, disponibili nei colori verde, viola, rosso, giallo e satinato.

Gli articoli sono disponibili con vetri multicolore e a colore unico, a richiesta.

Frame in chromed metal or 24kt gold plated.

Glass diffuser coated with a heat process, available in green, purple, red, yellow and satin. The articles are available with multicoloured glass or with unique colour, on request.

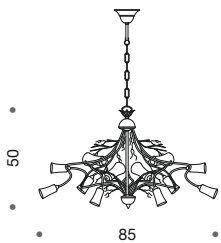

350/8+4
sospensione
suspension

12 x G9 MAX 25W
CE

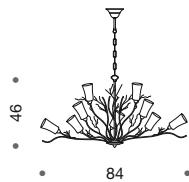

350/6+3
sospensione
suspension

9 x G9 MAX 25W
CE

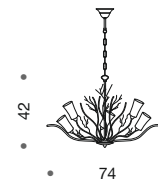

350/5
sospensione
suspension

5 x G9 MAX 25W
CE

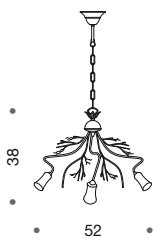

350/3
sospensione
suspension

3 x G9 MAX 25W
CE

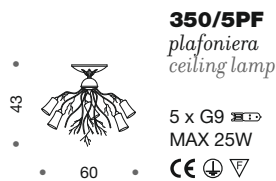

350/5PF
plafoniera
ceiling lamp

5 x G9 MAX 25W
CE

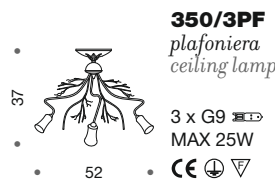

350/3PF
plafoniera
ceiling lamp

3 x G9 MAX 25W
CE

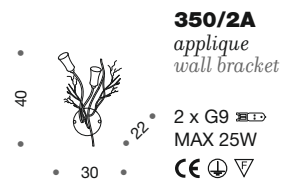

350/2A
applique
wall bracket

2 x G9 MAX 25W
CE

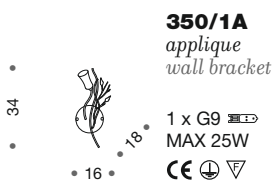

350/1A
applique
wall bracket

1 x G9 MAX 25W
CE

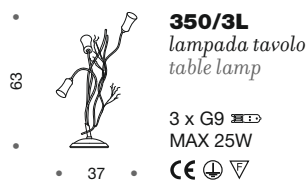

350/3L
lampada tavolo
table lamp

3 x G9 MAX 25W
CE



350/1L
lampada tavolo
table lamp

1 x G9 MAX 25W
CE

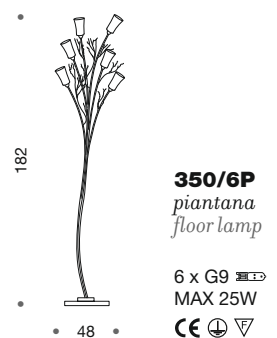

350/6P
piantana
floor lamp

6 x G9 MAX 25W
CE

Condizioni generali di vendita

1) VALIDITÀ E DIRITTO DI MODIFICA

a - Qualsiasi contratto tra I.D.L. Export S.r.l. (in prosieguo indicata come " il Venditore ") per la fornitura di suoi prodotti a un cliente (in prosieguo indicato come " l'Acquirente ") sarà disciplinato dalle presenti Condizioni Generali di Vendita che sostituiscono tutte le precedenti Condizioni Generali di Vendita.

b - Il Venditore si riserva il diritto di modificare le presenti Condizioni Generali di Vendita, allegando tali modifiche alle offerte, alle conferme o a qualsivoglia corrispondenza inviata all'Acquirente.

2) ACCETTAZIONE DEGLI ORDINI

a - Qualsivoglia ordine dell'Acquirente diverrà impegnativo solo se effettuato in forma scritta, anche via fax, e se espressamente confermato per iscritto dal Venditore, anche via fax.

3) CATALOGHI E LISTINI

a - Cataloghi, listini prezzi e altro materiale promozionale, benché redatto e fornito in buona fede, costituisce solo una indicazione del tipo di prodotti e di prezzi e le informazioni ivi indicate non sono impegnative per il Venditore; in particolare le fotografie dei prodotti non rappresentano un campione degli stessi.

4) CONSEGNA

a - Salvo patto contrario la consegna dei prodotti s'intende franco fabbrica e ciò anche quando sia convenuto che la spedizione o parte di essa venga curata dal Venditore.

b - I rischi di perimento passano all'Acquirente al momento della consegna dei prodotti al primo vettore o spedizioniere presso lo stabilimento del Venditore, indipendentemente da chi sia tenuto a sopportare le spese di trasporto. Con tale rimessa al primo vettore o spedizioniere il venditore ha adempiuto all'obbligo di consegna.

c - Il termine di consegna indicato nella Conferma d'Ordine è indicativo e non vincolante.

5) TERMINI E CONDIZIONI DI PAGAMENTO

a - Il prezzo deve essere pagato nel luogo ove il Venditore ha la sua sede.

b - Il Venditore può opporre il pagamento dell'intero prezzo come condizione della consegna dei prodotti.

c - In caso di ritardato pagamento rispetto alla data pattuita

l'Acquirente sarà automaticamente tenuto a corrispondere interessi di mora senza che vi sia bisogno di alcuna richiesta o altra formalità da parte del Venditore.

6) DENUNCIA DIFETTI

a - Qualora non l'abbia già effettuata, l'Acquirente ha l'onere di effettuare piena ed attenta verifica dei prodotti non appena questi gli siano stati effettivamente consegnati.

b - L'Acquirente decade dal diritto di far valere un difetto di conformità o un vizio o una mancanza di qualità dei prodotti se non ne fa denuncia in forma scritta al Venditore, precisando la natura del difetto, entro 10 giorni dalla data in cui i prodotti gli sono stati effettivamente consegnati.

7) GARANZIE DEL VENDITORE

a - Salvo il caso di dolo o colpa grave, in caso di difetto di conformità o di vizi o di mancanza di qualità dei prodotti, il Venditore sarà tenuto unicamente alla riparazione degli stessi. L'Acquirente non potrà esigere altri prodotti in sostituzione a meno che il difetto non costituisca una inosservanza essenziale del contratto e tale richiesta sia stata fatta al momento della sua denuncia. Rimane inteso che l'obbligo di riparare o sostituire i prodotti esclude ogni altra responsabilità del venditore per risarcimento danni.

8) LEGGE APPLICABILE

a - Il contratto è disciplinato dalla legge italiana e, per quanto riguarda le obbligazioni contrattuali, viene esclusa l'applicazione delle norme di diritto internazionale privato italiano e dunque ogni rinvio che esse dovessero fare alla legge di altri paesi o a convenzioni internazionali.

9) FORO COMPETENTE ESCLUSIVO

a - Per ogni controversia derivante dal contratto o ad esso connessa è competente in via esclusiva il Foro di Castelfranco Veneto (Tribunale di Treviso sezione distaccata di Castelfranco Veneto o Giudice di Pace di Castelfranco Veneto). L'Acquirente dichiara di conoscere ed approvare le condizioni generali di contratto riportate sul catalogo/ listino prezzi e sul retro della proposta di commissione di cui in particolare approva specificatamente le clausole di seguito richiamate: 5b -; pagamento del prezzo come condizione di consegna; 6b - decadenza dal diritto di far valere un difetto di conformità o un vizio o una mancanza di qualità dei prodotti; 7a - limitazione di responsabilità; 9a - foro competente esclusivo.

General sales conditions

1) VALIDITY AND RIGHT OF CHANGE

a - Any contract between I.D.L. Export S.r.l. (from now on it will be indicated as "Seller") and a customer (from now on it will be indicated as "Buyer") concerning the supply of IDL articles will be regulated by the following General Conditions of Sale that replace all the previous General Conditions of Sales.

b - The Seller reserves the right to modify these General Conditions of Sale by enclosing the changes in the offers, in the order confirmations or in any other correspondence with the Buyer.

2) ORDER ACCEPTANCE

a - Any order placed by the Buyer will be binding for the Seller only if made in writing (also by fax) and only if confirmed in writing by the Seller (also by fax).

3) CATALOGUE AND PRICE LIST

a - Catalogues, price lists and advertising material are drawn up in good faith; anyway the information enclosed is not binding for the Seller and it serves as indication of the articles that will be sold and their price. In particular the pictures of the products do not represent a sample of them.

4) DELIVERY

a - Different agreement excepted, the delivery of the goods is supposed to be EX WORKS even if the parties of the contract decide that the Seller must take care of the dispatch or of a part of it.

b - The risk concerning the damage of the goods is transferred to the Buyer when the goods are delivered to the first carrier or to the forwarding agent in the Seller's premises. This risk passes to the Buyer independently of the part that must meet the transports cost. The Seller will fulfil the delivery's obligation by giving the goods to the first carrier or to the forwarding agent.

c - The delivery date indicated on the Order Confirmation is just indicative and not binding.

5) CONDITIONS OF PAYMENT

a - The price must be paid to the Seller's head offices.

b - The Seller can require the payment of the whole price

as essential condition for the delivery of the goods.

c - In case of delayed payment the Buyer must automatically pay interests of arrears without any special Seller's request.

6) NOTIFICATION OF DEFECTS

a - Unless the Buyer has already checked the goods, he must check them as soon as he receives them.

b - In case of conformity defects, vices or bad quality, the Buyer loses the possibility to exercise his right if he does not complain in writing to the Seller within 10 days from the receipt of the goods and by specifying the nature of the defect he is complaining about.

7) GUARANTEE

a - Fraud and heavy fault excepted, in case of conformity defects, vices or bad quality, the Seller must only repair the complained items. The Buyer cannot require the replacement of the products unless the defect represents an essential non-observance of the contract and if this request was made when this defect was declared. The replacement of the goods or the reparation of them let the Seller free from any other obligation concerning the claim for damages.

8) LAW ENFORCEABLE

a - The present contract is regulated by the Italian Law. As for the contract's obligations, the enforcement of the International Italian private law is excluded and also any reference to the international law or to the law of other countries.

9) SOLE COMPETENT FORUM

a - For any dispute concerning the contract the sole competent forum is in Castelfranco Veneto (Court of Treviso, Department of Castelfranco Veneto or Justice of Peace of Castelfranco Veneto). The Buyer declares to know and to accept the General Conditions of Sale indicated in the catalogue/ the price list and on the back of the trial commission order. In particular the Buyer accepts the following clauses:

5b - payment of the whole price as condition for the delivery; 6b - losing of the right to comply a conformity defect, vice or the bad quality of the products; 7a - limit liability; 9a - sole competent forum.

IDL EXPORT S.R.L.

VIA S. MARCO, 2 - 31050 FANZOLO DI VEDELAGO (TV) ITALY
TELEFONO 0039 0423 487141 - FAX 0039 0423 476206
WWW.IDLEXPORT.IT - INFO@IDLEXPORT.IT

IDL SI RISERVA IL DIRITTO DI APPORTARE MODIFICHE E/O MIGLIORIE AI PRODOTTI ILLUSTRATI NEL PRESENTE CATALOGO SENZA ALCUN OBBLIGO DI PREAVVISO.
IDL RESERVES THE RIGHT TO MAKE CHANGES AND / OR IMPROVEMENTS TO THE PRODUCTS DESCRIBED IN THIS CATALOG WITHOUT PRIOR NOTICE.

TUTELA SUI DIRITTI D'AUTORE. LEGGE 22/4/1941 N°633, LEGGE 14/12/1942 N°1485
PROIBITA OGNI RIPRODUZIONE ANCHE PARZIALE
SAFEGUARDED BY THE LAW ON COPYRIGHT

Realizzazione:
© **Ditre Group**

Fotografia:
quasarfoto.com

Bank Image:
shutterstock.com

Printing:
ditre.com

