

nh
by
Neri & Hu



Artemide®

nh

Authors

Neri & Hu

Founded in 2004 by partners Lyndon Neri and Rossana Hu, Neri & Hu Design and Research Office is an inter-disciplinary architectural design practice based in Shanghai, China with an additional office in London, UK. Neri & Hu works internationally providing architecture, interior, master planning, graphic, and product design services. Currently working on projects in many countries, Neri & Hu is composed of multi-cultural staff who speak over 30 different languages. The diversity of the team reinforces a core vision for the practice: to respond to a global worldview incorporating overlapping design disciplines for a new paradigm in architecture.

Neri & Hu believes strongly in research as a design tool, as each project bears its unique set of contextual issues. A critical probing into the specificities of program, site, function, and history is essential to the creation of rigorous design work. Based on research, Neri & Hu desires to anchor its work on the dynamic interaction of experience, detail, material, form, and light rather than conforming to a formulaic style. The ultimate significance behind each project comes from how the built forms create meaning through their physical representations.

Neri & Hu and their design have been recognized by a number of prestigious international design awards: Maison&Objet named them "Asia Designers of The Year 2015", UK Wallpaper* announced the Founding Partners Lyndon Neri and Rossana Hu as "2014 Designers of The Year"; they were also listed among the 40 most prominent designer "under 40" that are shaping the Greater China.



NH

Neri & Hu 2018

nh continues the study on the dynamic interaction of expertise, details, materials, form, and light that Neri & Hu are developing with Artemide.

nh1217 in the table version is designed as a simple, versatile, practical appliance that can be laid or suspended.

A white blown glass sphere slides along a brushed brass ring, which allows it to take different positions and to freely adjust and direct the diffuser. The frame becomes a support, a hook to hang the appliance to the wall, or a handle promoting an interaction with light.

Starting from this first element Neri & Hu develop a series of structures to bring light into space.

The glass sphere with hook is declined in three diameters (14, 22, 35 cm).

Suspensions with linear support elements or with curved geometries accommodate spheres of different sizes.

The structures create a graphic balance of elements on which the luminous spheres are free to move and bring the light to different positions.

nh family is completed with a wall and a floor version.

The selected materials represent a perfect combination of tradition and innovation, as well as the expression of responsible and sustainable design, also conveyed by the use of a low consumption retrofit LED source.

Like all the projects designed by Neri & Hu, nh offers a reinterpretation of the Oriental culture and tradition with a constant contemporary approach.

nh is operated intuitively as a reference to

the use of lanterns, and allows freedom in creating countless lightscares. It is an essential, versatile element, suited to illuminate a variety of contexts in a simple and poetic manner.

With surprising lightness and elementary movements nh creates a landscape of elements generating – either individually or combined with each other – a non-static balanced composition characterized by elegant colour and material matching.



nh 1217





Interactive

nh1217 is a modern update to the traditional lantern. Its flexible brass handle allows the diffuser to be adjusted so that the lamp can be positioned in different ways. The brass handle can be used as a base for a table lamp or as a hook to hang the appliance from a wall or suspend it from the ceiling.



nh Wall

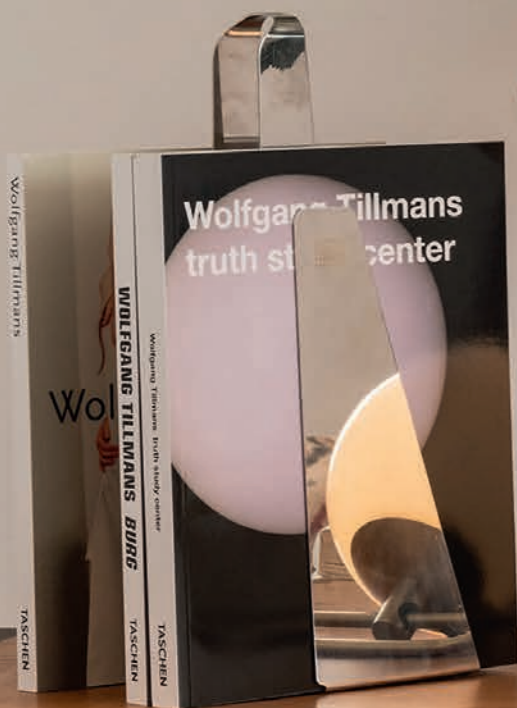

nh 22 Floor



Variety

The nh family is available in a floor version, reinforcing the idea of the fixture as a modern update of a lantern, with a large glass diffuser suspended from the arm of the lamp. A simple suspension with one glass diffuser is available in a range of options, with a selection of arm lengths and diffuser sizes designed to complement any interior





nh S 14



nh S 22



nh S 35



Tradition & Innovation

The fixture is crafted of a blown glass diffuser and a brushed brass ring. nh1217 builds on the dynamic interaction of experience, details, materials, form, and light that are at the core of projects and research that Neri & Hu are developing with Artemide.



A landscape of light elements

In the suspension version, a light metal rod is hung horizontally and supports the brass ring that holds the sphere.

The base element of nh thus moves freely in space, the luminous sphere is free to slide and take light to different positions.

This structure is then repeated on two or three levels in a cluster element that also introduces the possibility to change the angles generated between the rods: one of the suspension cables is shared by the rods, whereas the other can be set freely in space to define the overall geometry.

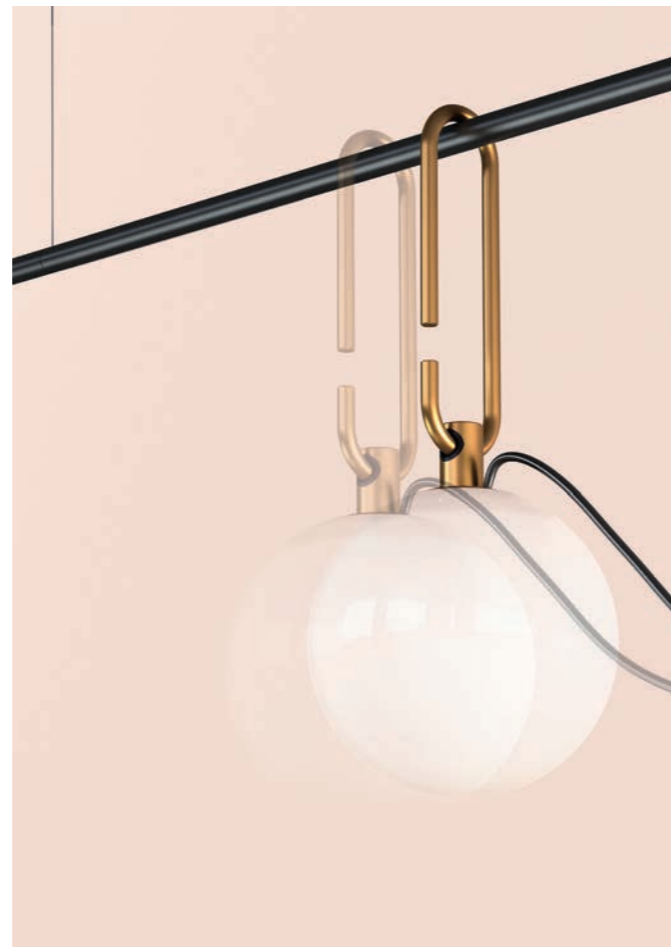

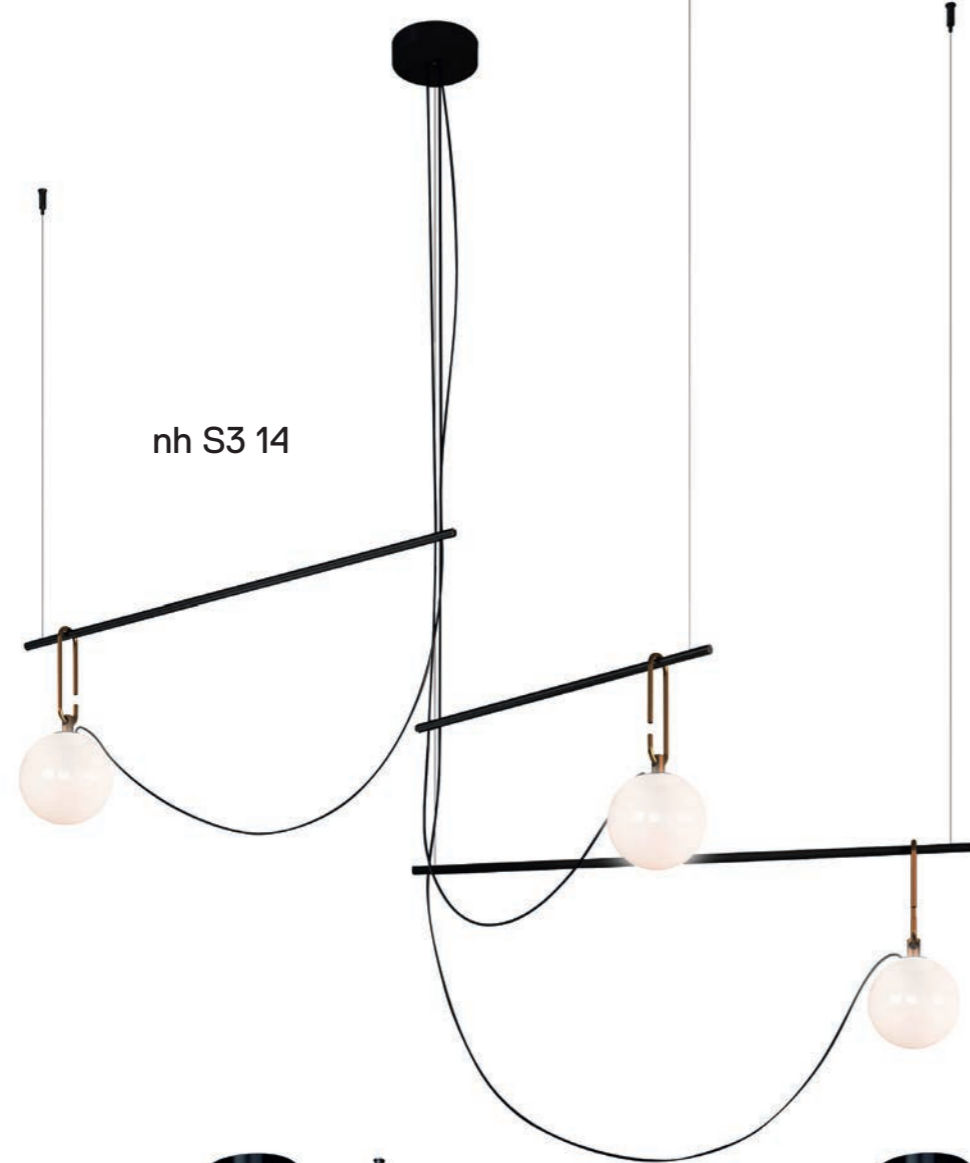

nh S3 14



nh S3 2 arms



nh S1 14

nh S2 14



nh S1 22

nh S2 22

nh S3 2 arms



Dynamic interaction of
experience, details and
materials



nh S4 Circulaire

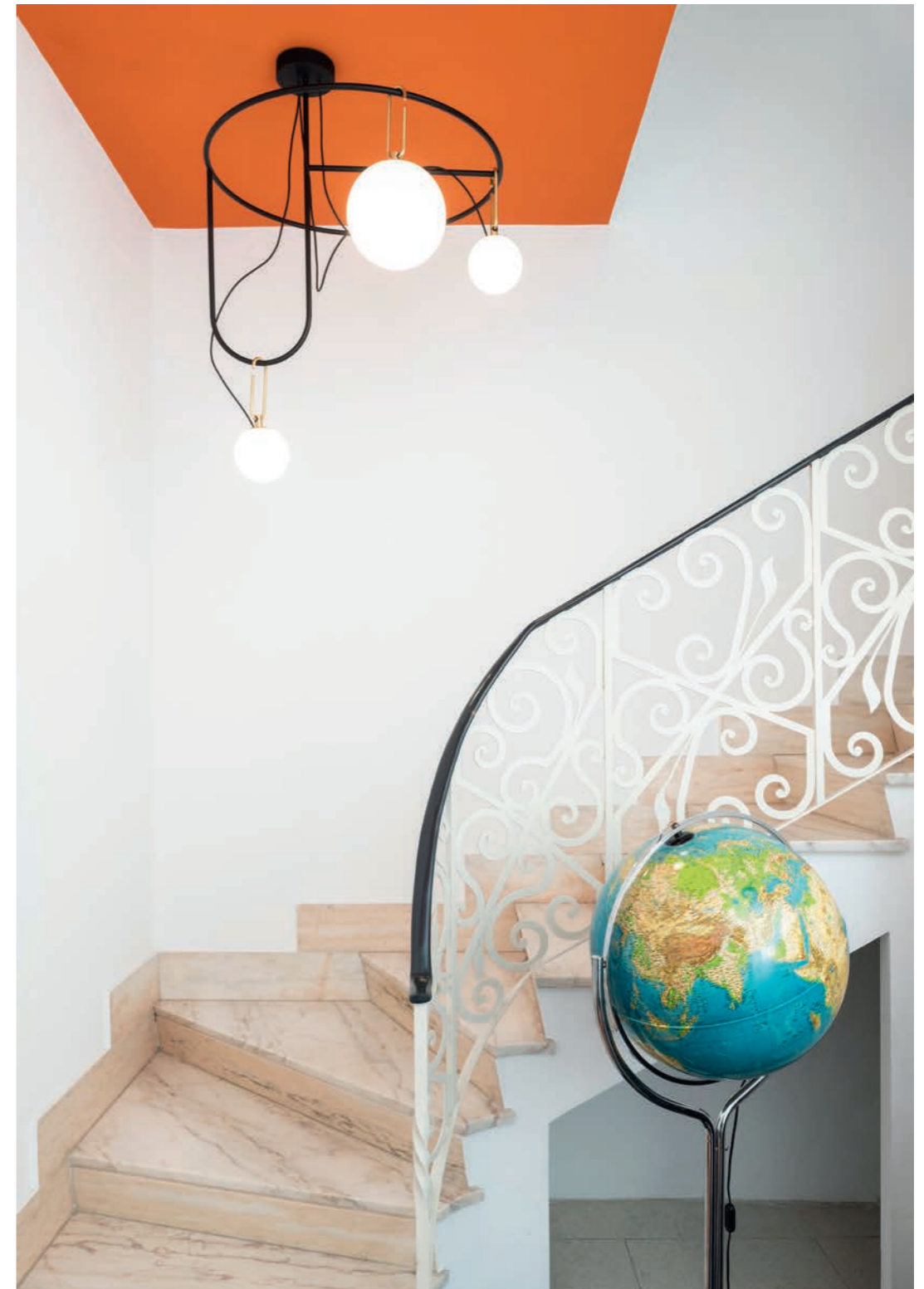

nh S5 Elliptic



nh

Materials:

Blown glass diffuser, brass, aluminium

Colours:

Opal white glass, brushed natural brass, black painted body

nh 1217/ nh WALL:

Power: 5W LED (E14)

nh S1 14/ nh S2 14/ nh S 14:

Power: 5W LED DIM (E14)

nh S1 22/ nh S2 22/ nh S 22:

Power: 15W LED DIM (E27)

nh S3 CLUSTER:

Power: 3x5W LED DIM (E14)

nh S3 2 ARMS:

Power: 2x15W LED DIM (E27)

nh S4 CIRCULAIRE:

Power: 2x5W LED DIM (E14) + 1x15W LED (E27)

nh S5 ELLIPTIC:

Power: 2x15W LED DIM (E27) + 4x5W LED (E14)

nh S 35:

Power: 20W LED DIM (E27)

nh 22 FLOOR:

Power: 15W LED DIM (E27)

nh S1/S2 14

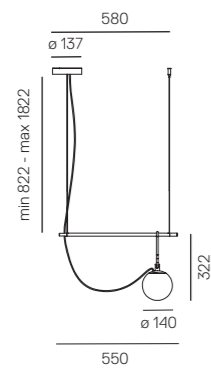

nh WALL

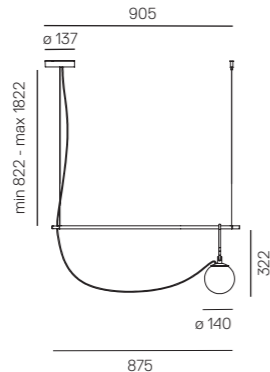

nh 22 FLOOR

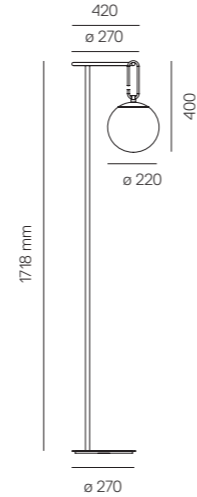

nh S3 CLUSTER

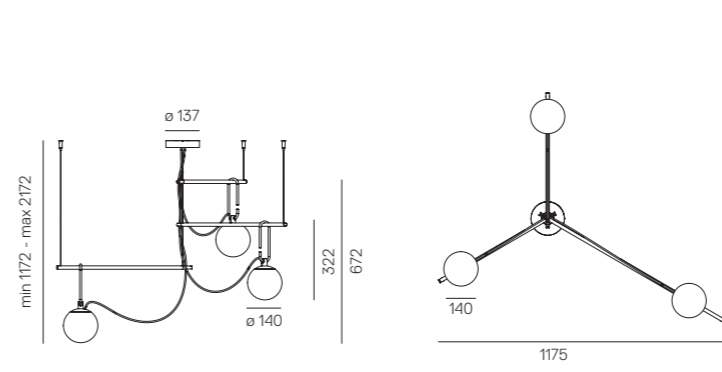

nh S3 2 ARMS

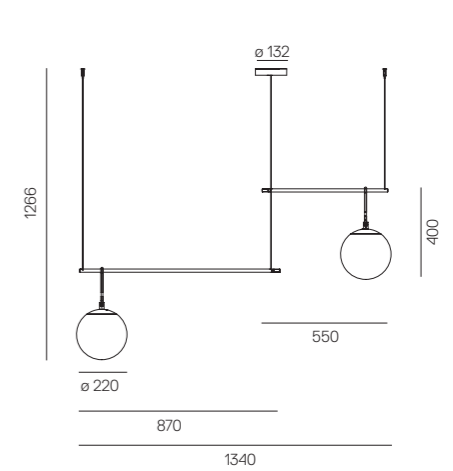

nh S1/S2 22

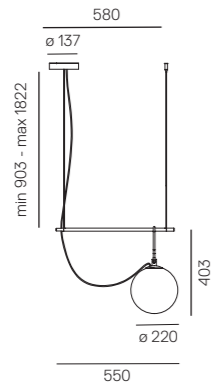

nh S 14



nh S 22



nh S 35



nh S4 CIRCULAIRE

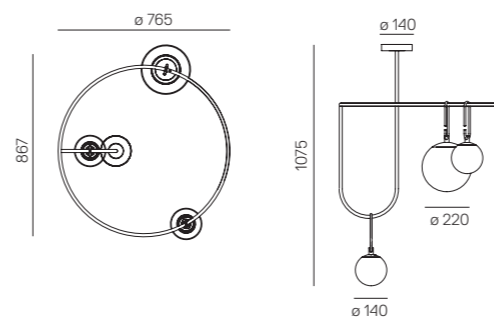

nh 1217

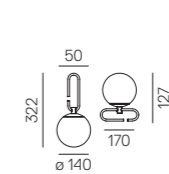

nh S5 ELLIPTIC

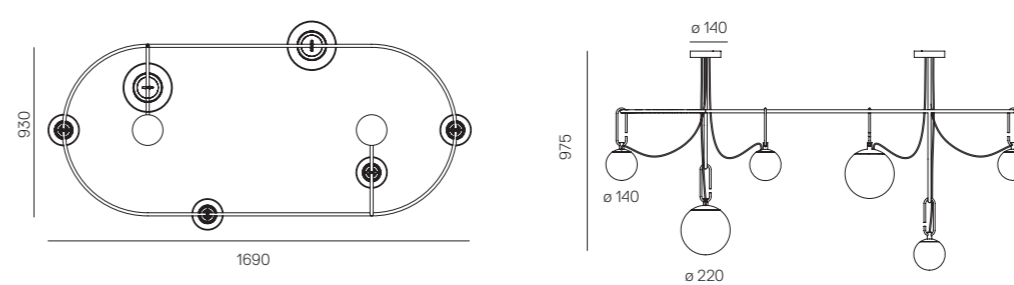

nh S1/S2 14 - nh S1/S2 22/ nh Wall: cable length 2700 mm

nh

nh 1217 W 5 W	Code 1217010A
nh WALL W 5 W	Code 1277010A
nh 22 FLOOR W 15 W	Code 1271010A
nh S 14 W 5 W	Code 1280010A
nh S 22 W 15 W	Code 1281010A
nh S 35 W 20 W	Code 1283010A
nh S1 22 W 15 W	Code 1273010A
nh S2 22 W 15 W	Code 1275010A
nh S1 14 W 5 W	Code 1272010A
nh S2 14 W 5 W	Code 1274010A
nh S3 2 ARMS W 2x15 W	Code 1282010A
nh S3 CLUSTER W 3x5 W	Code 1276010A
nh S4 CIRCULAIRE W 2x5 W- 1x15 W	Code 1278010A
nh S5 ELLIPTIC W 4x5 W- 2x15 W	Code 1279010A

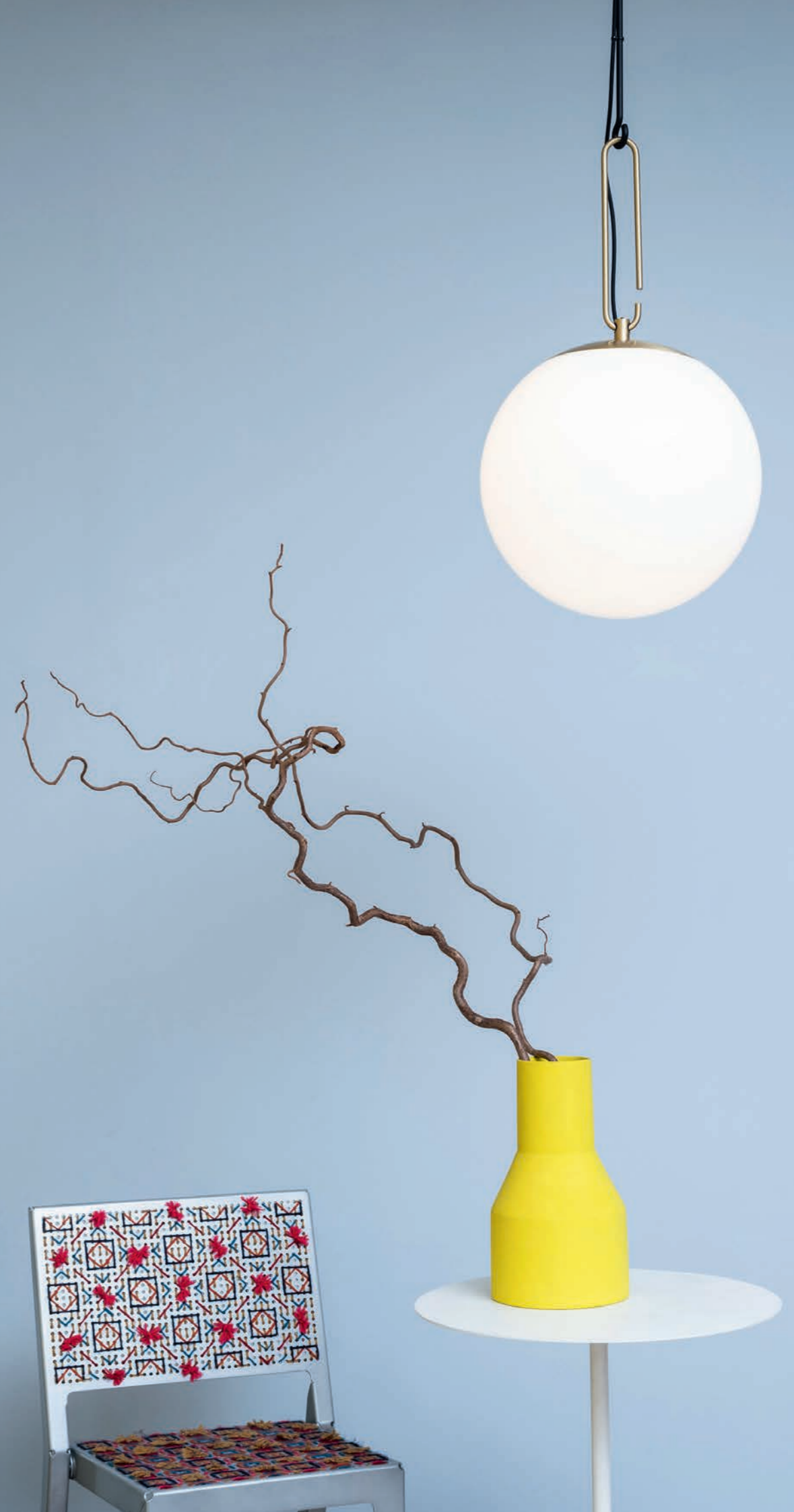

Artemide®

Headquarters

Artemide S.p.A.

Via Bergamo, 18
20010 Pregnana Milanese (MI), Italy
Tel. +39 02 93518.1
Tel. +39 02 93526.1
Numero verde 800 834 093
(Italy only)
info@artemide.com
artemide.com

Communication and Marketing Department

Via Canova, 34
20145 Milan (MI), Italy
Tel. +39 02.349611
marketing@artemide.com
artemide.com

Artemide S.p.A.

si riserva la facoltà di modificare, in qualunque momento e senza preavviso, le caratteristiche tecniche degli elementi illustrati nel presente catalogo.

Artemide S.p.A.

reserves the right to change, at any time and without prior warning, the technical specifications of any product illustrated in this catalogue.

Artemide S.p.A.

se réserve le droit de modifier, à n'importe quel moment et sans préavis, les caractéristiques techniques des éléments illustrés dans ce catalogue.

Artemide S.p.A.

behält sich das Recht vor jederzeit und ohne Ankündigung die technischen Daten der im Katalog abgebildeten Produkte zu ändern.

Artemide S.p.A.

se reserva la facultad de modificar, en cualquier y sin aviso previo, las características técnicas de los elementos ilustrados en el presente catálogo.

For information regarding distributors
and points of sale, please visit our website
artemide.com or email: info@artemide.com



ISO 9001:2015



ISO 14001:2015



ISO 45001:2018



CTF STAGE2
ISO 17025

Artemide[®]