

# Walking



**Artemide®**



# Walking

Carlotta de Bevilacqua

↪ 2017

Walking is a family of outdoor appliances that design dynamic lighting landscapes with a new and different approach focused on human perception for visual and psychological details.

It can create different luminous landscapes starting from three white or coloured lighting performances,

either single or combined within the same element according to a space gradient of structures of different heights.

It defines a new, exciting lighting language, respectful of the surrounding space, which it approaches with deeds that promote its perception and a man-sized experience. A dynamic discovery of space that is allowed, among other things, by the possible interaction with sensors, the Artemide App and advanced intelligences.

either single or combined within the same element according to a space gradient of structures of different heights.

It defines a new, exciting lighting language, respectful of the surrounding space, which it approaches with deeds that promote its perception and a man-sized experience. A dynamic discovery of space that is allowed, among other things, by the possible interaction with sensors, the Artemide App and advanced intelligences.

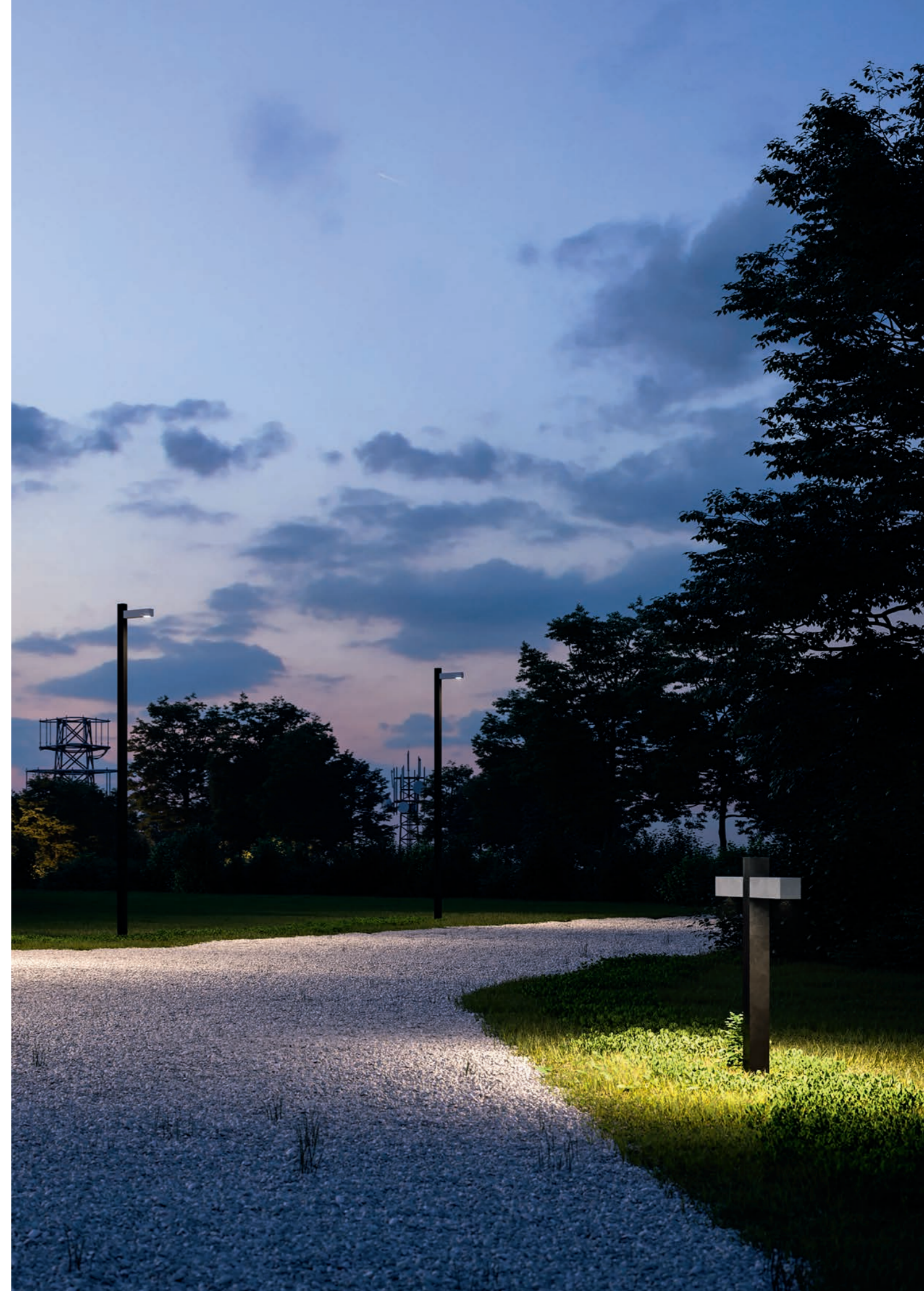







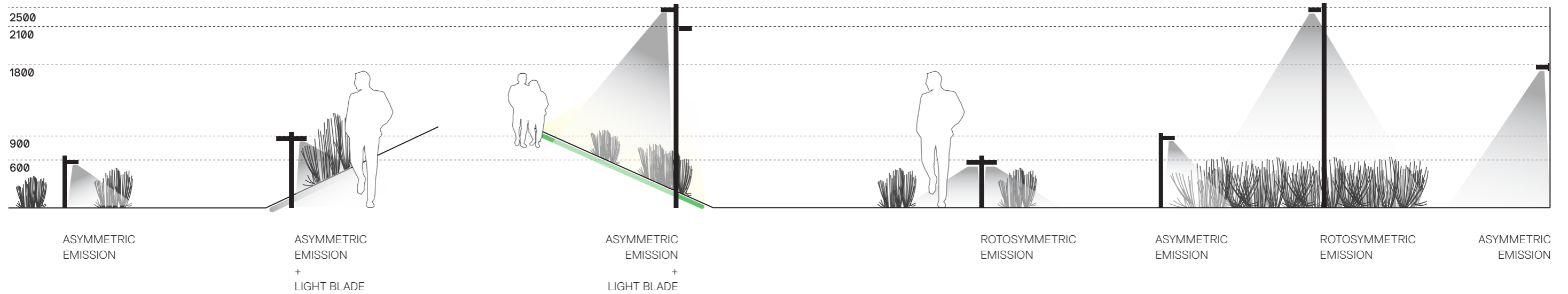

LIGHT BLADE

# Walking optical system

It can create different luminous landscapes starting from three white or coloured lighting performances, either single or combined within the same element according to a space gradient of structures of different heights.

It defines a new, exciting lighting language, respectful of the surrounding space, which it approaches with deeds that promote its perception and a man-sized experience. A dynamic discovery of space that is allowed, among other things, by the possible interaction with sensors, the Artemide App and advanced intelligences.

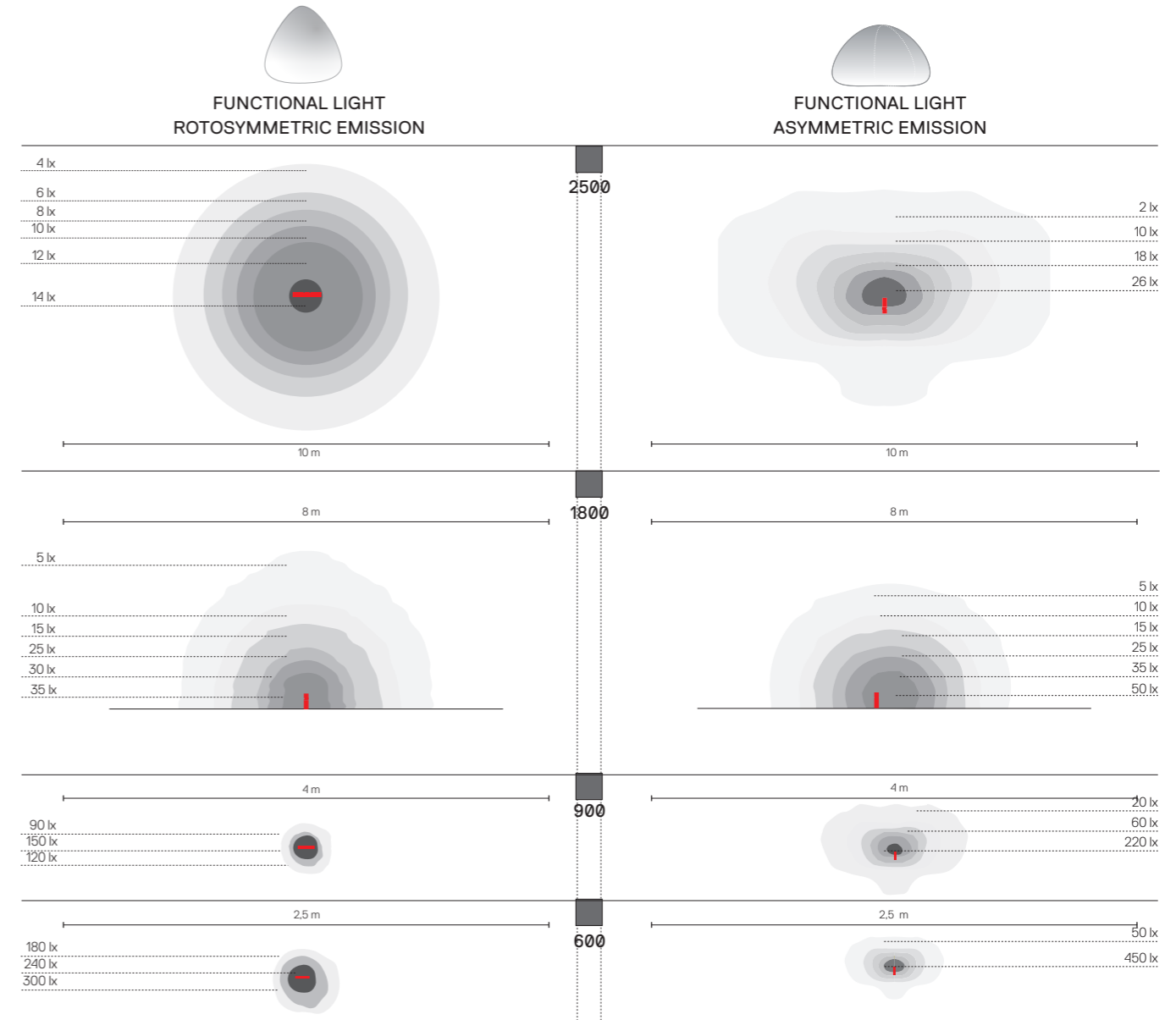
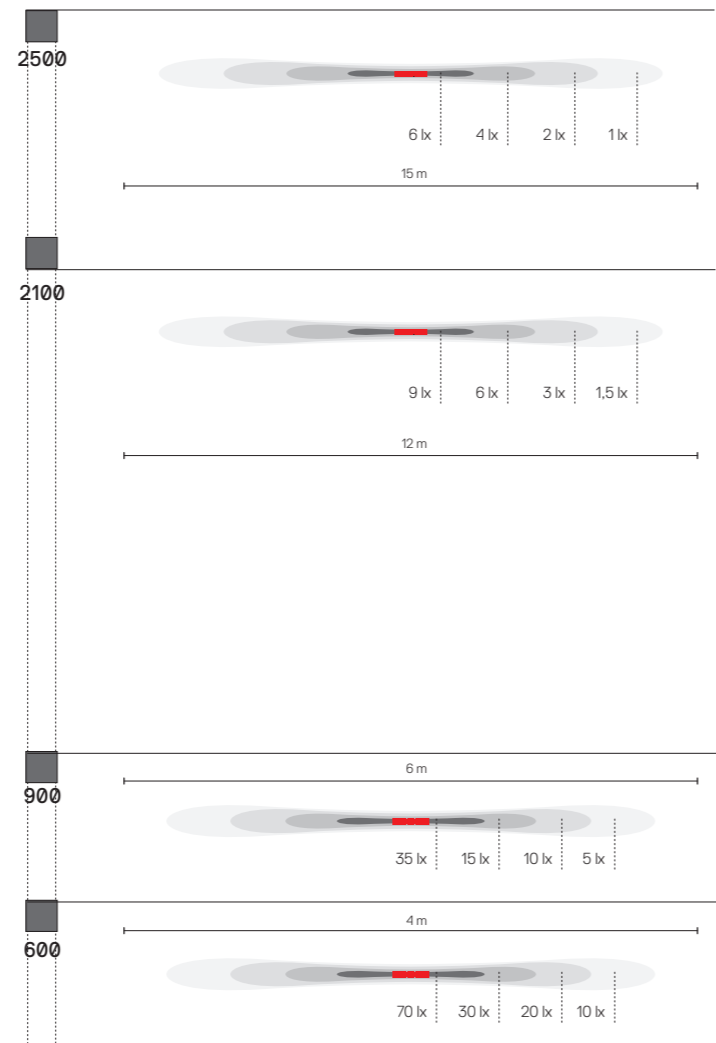

# Walking head pole typologies

# Walking wall typologies

## FUNCTIONAL LIGHT

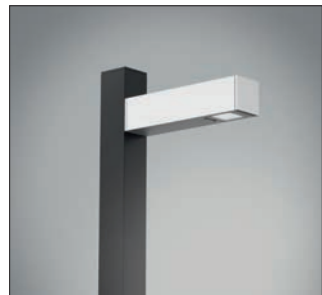

ROTSYMMETRIC EMISSION



5 2x63°  
10,3W  
334 lm



ASYMMETRIC EMISSION



5 2x60° / 16°+54°  
10,3W  
455 lm

## LIGHT BLADE

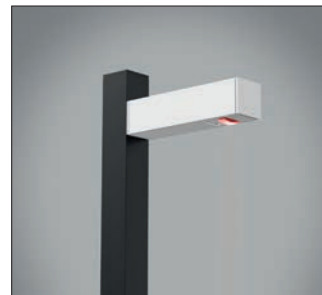

RED EMISSION



GREEN EMISSION



BLUE EMISSION



WHITE EMISSION

## FUNCTIONAL LIGHT



ROTSYMMETRIC EMISSION



5 2x63°  
10,3W  
334 lm



ASYMMETRIC EMISSION



5 2x60° / 16°+54°  
10,3W  
455 lm

## LIGHT BLADE



RED EMISSION



GREEN EMISSION

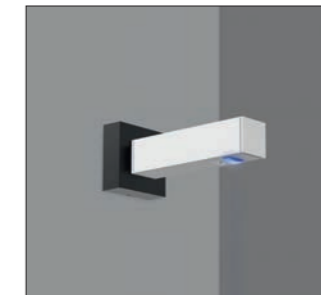

BLUE EMISSION



WHITE EMISSION



Artemide  
App  
↪ on request



For further information on Walking  
↪ visit [artemide.com](http://artemide.com)



# Walking pole configuration typologies

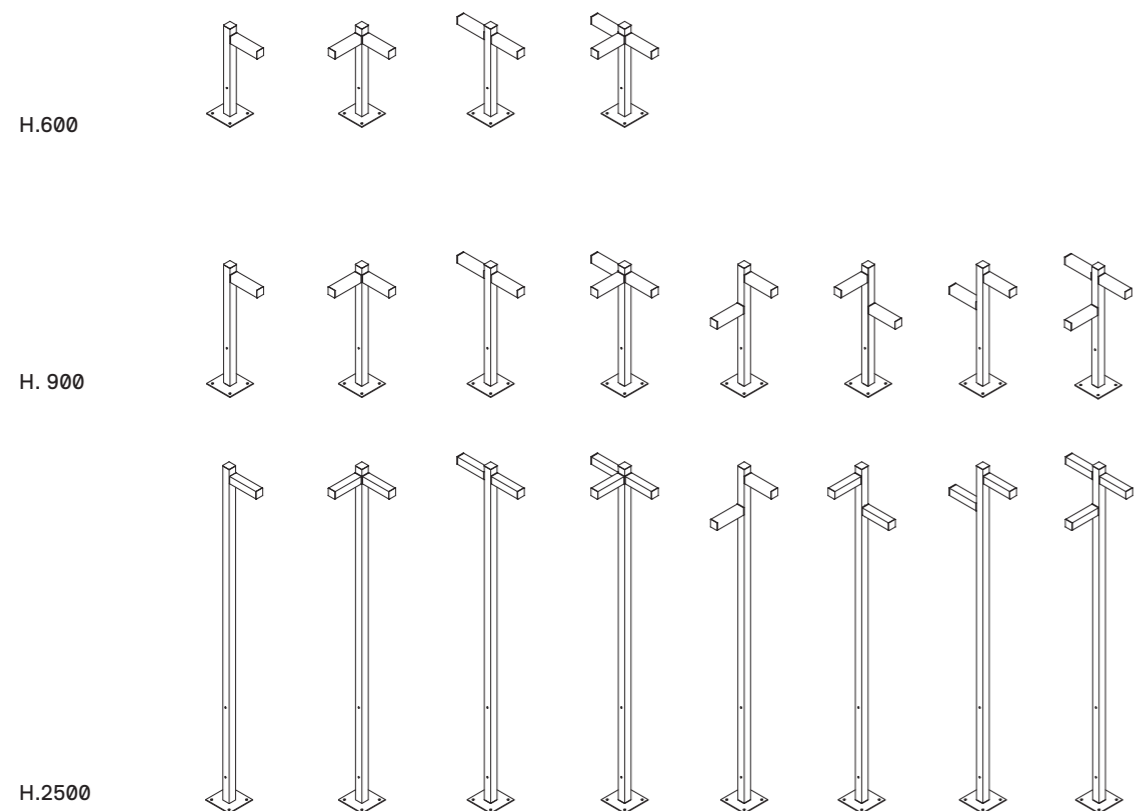





# Walking head colors

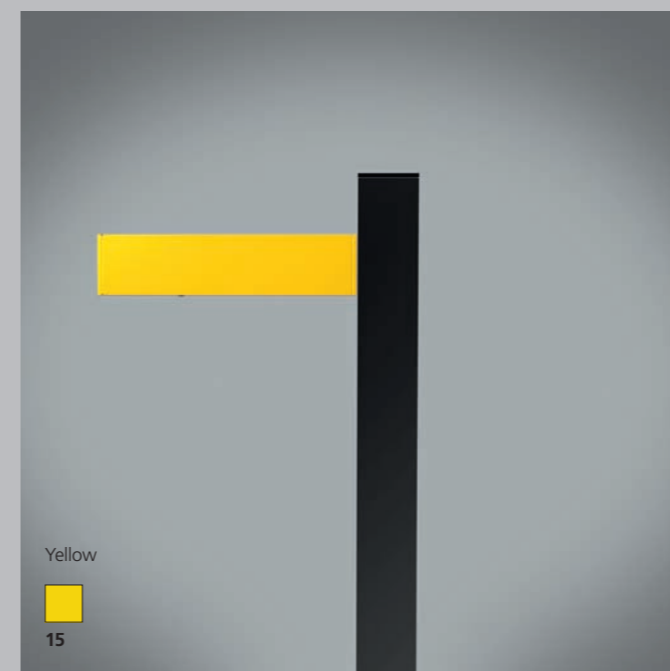
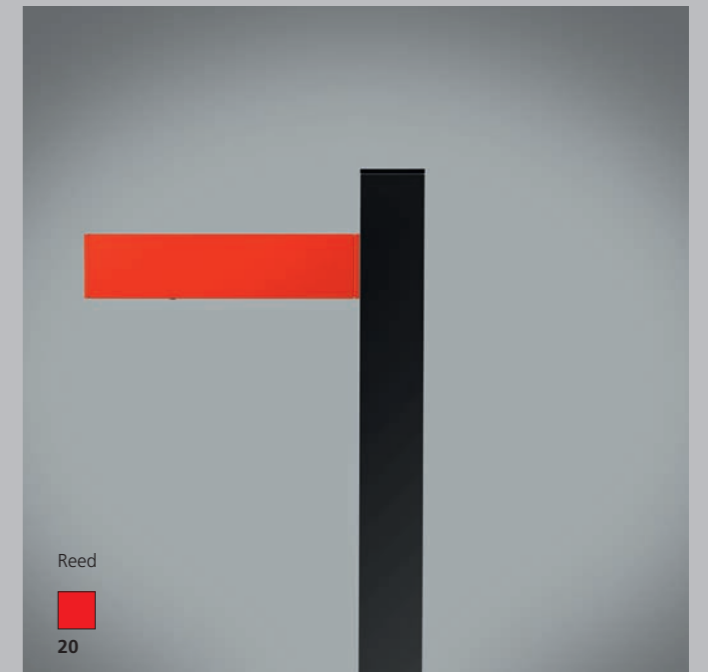
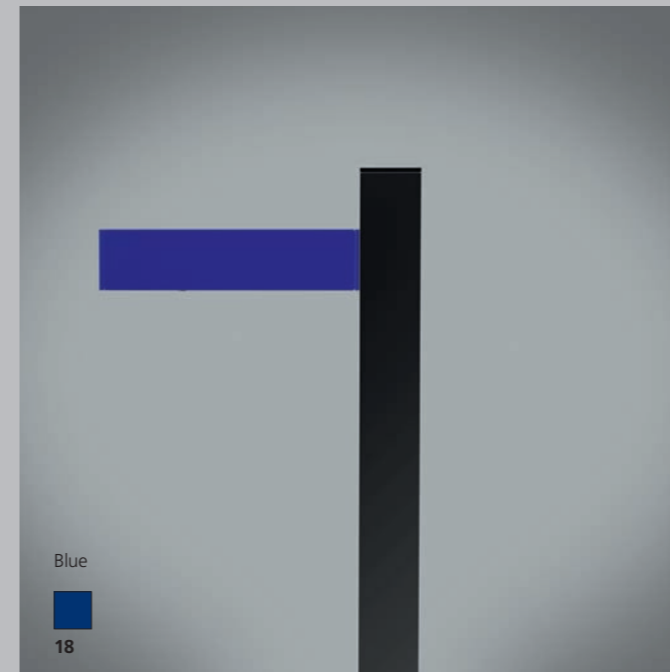
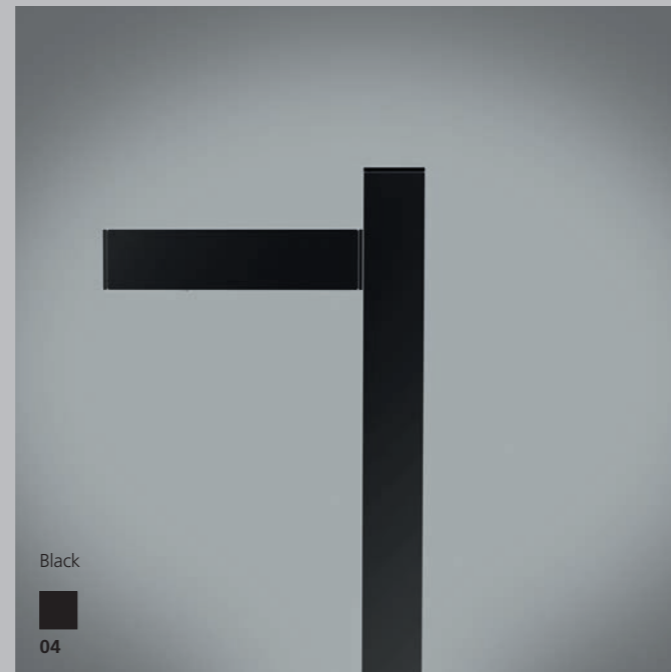
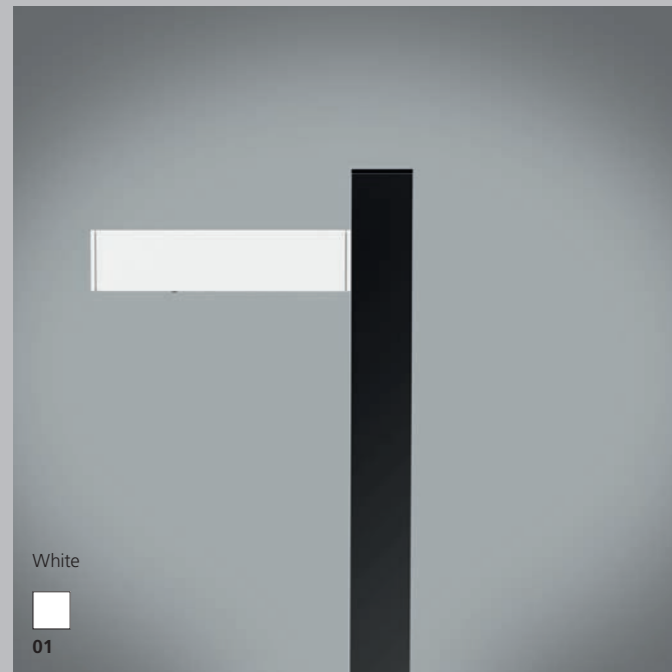



## ↪ WALKING - POLE

Black



### POLE 600

Pole configuration		Code
Head	A Head	
	1x 60 h.	<b>T4505A30</b>
	2x90° 60 h.	<b>T4505B30</b>
	2x180° 60 h.	<b>T4505C30</b>
	3x270° 60 h.	<b>T4505D30</b>

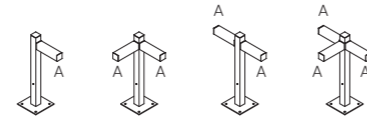

### POLE 900

Pole configuration		Code
Head	A Head up B Head down	
	1x 90 h.	<b>T4506A30</b>
	2x90° 90 h.	<b>T4506B30</b>
	2x180° 90 h.	<b>T4506C30</b>
	3x180° 90 h.	<b>T4506D30</b>
	2x90° 90 h. 60 h.	<b>T4506E30</b>
	2x90° 90 h. 60 h.	<b>T4506F30</b>
	2x180° 90 h. 60 h.	<b>T4506G30</b>
	3x180° 90 h. 60 h.	<b>T4506H30</b>

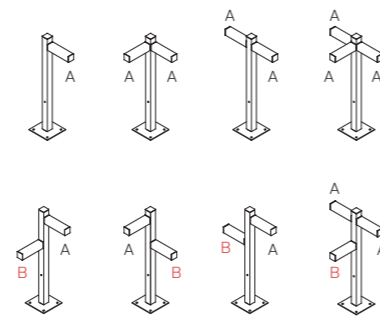

### POLE 2500

Pole configuration		Code
Head	A Head up B Head down	
	1x 250 h.	<b>T4507A30</b>
	2x90° 250 h.	<b>T4507B30</b>
	2x180° 250 h.	<b>T4507C30</b>
	3x180° 250 h.	<b>T4507D30</b>
	2x90° 250 h. 210 h.	<b>T4507E30</b>
	2x90° 250 h. 210 h.	<b>T4507F30</b>
	2x180° 250 h. 210 h.	<b>T4507G30</b>
	3x180° 250 h. 210 h.	<b>T4507H30</b>

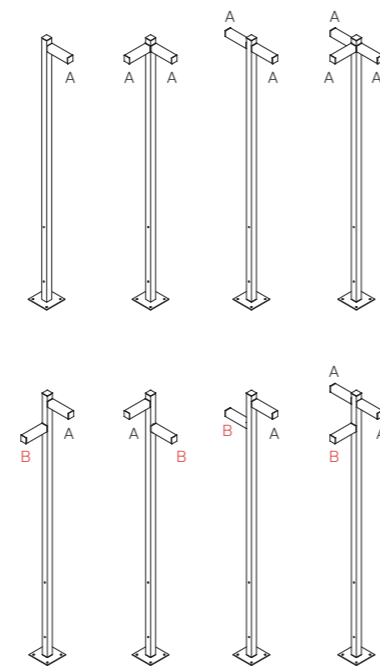

## ↪ WALKING - HEAD POLE

Grey-white Ral 9002	Blue	Black	Red	Yellow	S	AS
20	50	30	40	60		

MacAdam 7SDCM  
Life L90 (10K)>60500h  
CRI =80

IP65

### FUNCTIONAL LIGHT

W	L. Cable	Beam	Flux	CCT	Code
10,3 W	270	S	334 lm	3000K	<b>T4501SM0.</b> 20/30/40/50/60
		AS	455 lm	3000K	<b>T4501AS0.</b> 20/30/40/50/60

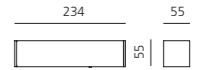

### LIGHT BLADE

W	L. Cable	Light color	Code
10,3 W	270	Red	<b>T4501LR0.</b> 20/30/40/50/60
		Green	<b>T4501LG0.</b> 20/30/40/50/60
		Blue	<b>T4501LB0.</b> 20/30/40/50/60
		White	<b>T4501LW0.</b> 20/30/40/50/60

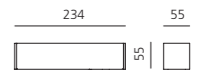



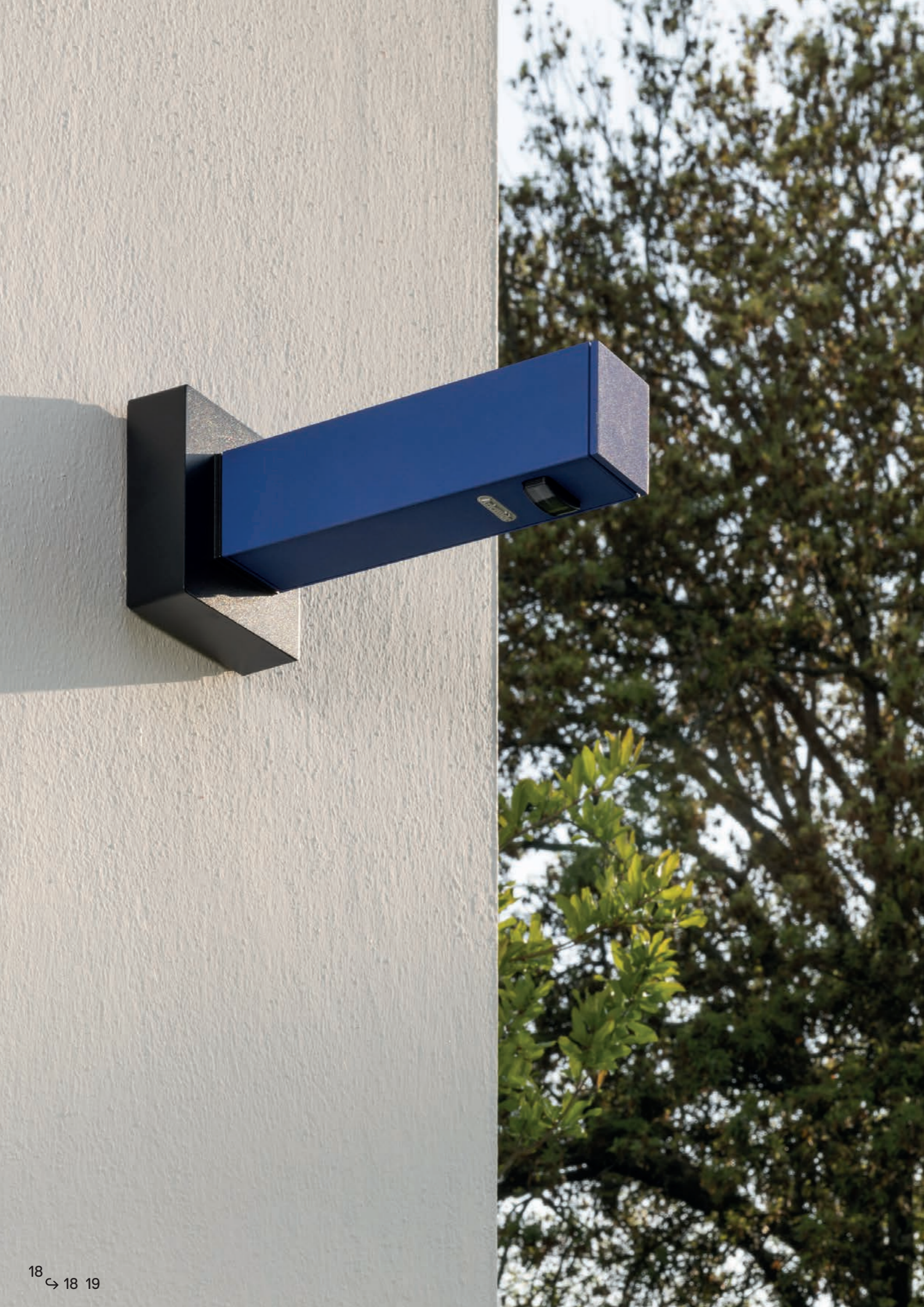

↔ WALKING - WALL

Grey-white Ral 9002	Blue	Black	Red	Yellow	S	AS	MacAdam 7SDCM Life L90 (10K)>60500h CRI =80	IP65
20	50	30	40	60				

FUNCTIONAL LIGHT

W	L. Cable	Beam	Flux	CCT	Code
10,3 W	270	S	334 lm	3000K	<b>T4503SM0.</b> 20/30/40/50/60
		AS	455 lm	3000K	<b>T4503AS0.</b> 20/30/40/50/60

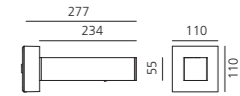

LIGHT SIGNS

W	L. Cable	Light color	Code
10,3 W	270	Red	<b>T4503LR0.</b> 20/30/40/50/60
		Green	<b>T4503LG0.</b> 20/30/40/50/60
		Blue	<b>T4503LB0.</b> 20/30/40/50/60
		White	<b>T4503LW0.</b> 20/30/40/50/60

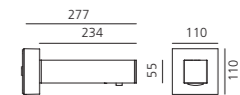



## Headquarters

### Artemide S.p.A.

Via Bergamo, 18  
20010 Pregnana Milanese (MI), Italy  
Tel. +39 02 93518.1  
Tel. +39 02 93526.1  
Numero verde 800 834 093  
(from Italy only)  
info@artemide.com  
artemide.com

## Communication and Marketing Department

Via Canova, 34  
20145 Milan (MI), Italy  
Tel. +39 02.349611  
marketing@artemide.com  
artemide.com



ISO 9001:2015



ISO 14001:2015



ISO 45001:2018

### Artemide S.p.A.

si riserva la facoltà di modificare, in qualunque momento e senza preavviso, le caratteristiche tecniche degli elementi illustrati nel presente catalogo.

### Artemide S.p.A.

reserves the right to change, at any time and without prior warning, the technical specifications of any product illustrated in this catalogue.

### Artemide S.p.A.

se réserve le droit de modifier, à n'importe quel moment et sans préavis, les caractéristiques techniques des éléments illustrés dans ce catalogue.

### Artemide S.p.A.

behält sich das Recht vor jederzeit und ohne Ankündigung die technischen Daten der im Katalog abgebildeten Produkte zu ändern.

### Artemide S.p.A.

se reserva la facultad de modificar, en cualquier y sin aviso previo, las características técnicas de los elementos ilustrados en el presente catálogo.